

# REMAK

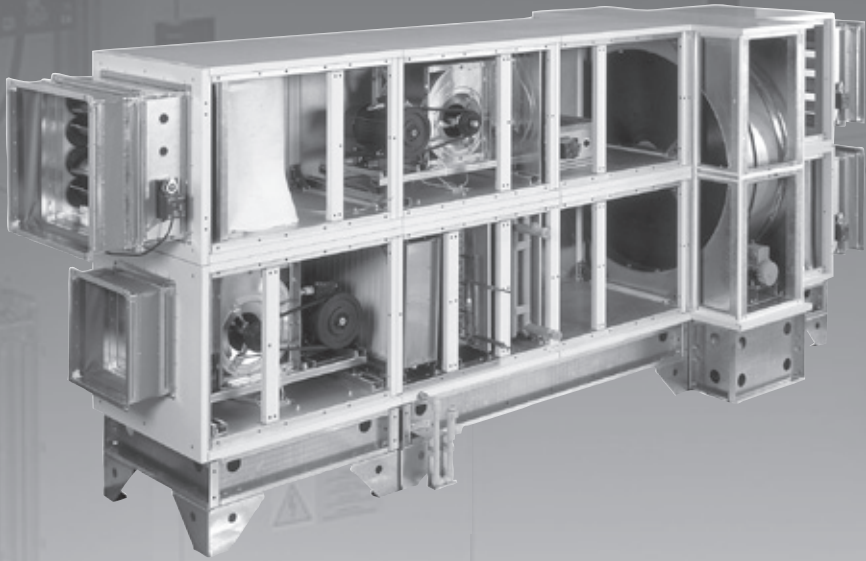

## Air Handling Units

# AERO MASTER XP

INSTALLATION AND OPERATING INSTRUCTIONS

05/2018

<b>Application, Operating Conditions and Construction</b> .....	<b>3</b>
Manufacturer's Notification.....	3
Application and Operating Conditions.....	3
Air-Handling Unit Construction.....	3
Air-Handling Unit Marking.....	3
Information and Safety Labels.....	3
Side Variability of Unit Connections.....	3
<b>Goods Despatch</b> .....	<b>4</b>
Delivery Content.....	4
Transport and Storage.....	4
Packaging.....	4
Transport and Handling of Air Handling Unit Components.....	4
Rotary Heat Exchanger Transport.....	6
Storage Conditions.....	6
<b>Installation</b> .....	<b>6</b>
Installation Site.....	6
Service Access.....	6
Pre-Installation Inspection.....	6
Identification of Air-Handling Unit Components.....	7
Assembly of Air-Handling Unit Sections.....	7
Installation of Covering Roof.....	8
Plate Heat Exchanger.....	9
Rotary Heat Exchanger.....	9
<b>Connection of Heat Exchangers</b> .....	<b>10</b>
Water and Glycol Heat Exchangers.....	10
<b>Connection of Water Heat Exchangers</b> .....	<b>10</b>
Direct Evaporators.....	10
Steam humidification.....	10
Condensate Drainage.....	11
<b>Other Connections</b> .....	<b>11</b>
Air-handling Duct Connection.....	11
Electric Equipment Wiring.....	11
Wiring of Motors.....	11
Wiring Diagrams – Fan Motors.....	12
Wiring Diagrams – Electric Heaters.....	13
<b>Start-Up Preparation and Commissioning</b> .....	<b>16</b>
Removing of Spacers from the Fan Section.....	16
Commissioning.....	16
Inspection Prior the First Start-Up.....	17
<b>Operating Checks and Service Regulations</b> .....	<b>17</b>
Unit Operation - Service Regulations.....	17
Unit Operation Screening Checks.....	17
Regular Inspections.....	17
<b>Spare Parts and Service</b> .....	<b>24</b>
Spare parts.....	24
Service.....	24
Disposal.....	24
Waste classification.....	24
<b>Complementary Information</b> .....	<b>25</b>
XPRJ and XPRF Sections.....	25
Integrated Cooling Section.....	26
XPTG Section.....	29
XPXB 2B/BS Plate Heat Exchanger Section.....	31
XPXR Regeneration Exchanger Section.....	33
Stacks of AeroMaster XP Air Handling Unit Sections.....	38
AeroMaster XP Air Handling Unit Adjustable and Fixed Feet.....	39
Removing the transport brace.....	40
Air Flow Rate Determination for Fans with Overhung Impeller.....	41
Connection of individual sections - complementary set XPSSxxDR.....	41
Automatic Backup of Fan Motors.....	42
Compact version of Air-Handling Units.....	43
Air-handling units modified for clean plants and health service.....	47

## General Information

- AeroMaster air handling units are manufactured in accordance with valid Czech and European regulations and technical standards.
- AeroMaster air handling units must be installed and used only in accordance with this documentation.
- The customer is responsible for any damages resulting from use other than intended.
- The installation and operating documentation must be available for the operating and servicing staff. It is advisable to store this documentation close to the installed air handling unit.
- When handling, installing, wiring, commissioning, repairing or servicing the AeroMaster air handling units, it is necessary to observe valid safety rules, standards and generally recognized technical rules. In particular, it is necessary to use personal protective work aids (e.g. gloves) because of sharp edges and corners when performing any handling, installing, dismantling, repairing or checking of AeroMaster air handling units. All equipment connections must comply with the respective safety standards and regulations.
- Any changes or modifications to individual components of the AeroMaster air handling units which could affect its safety and proper functioning are forbidden.
- Before installing and using the AeroMaster air handling units, it is necessary to familiarize yourself with and observe the directions and recommendations included in the following chapters.
- The AeroMaster air handling units, including their individual parts, are not intended, due to their concept, for direct sale to end customers. Each installation must be performed in accordance with a professional project created by a qualified air-handling designer who is responsible for the proper selection and dimensioning of components concerning their suitability for a given application.
- The installation and commissioning may be performed only by an authorized company licensed in accordance with generally valid regulations.
- When disposing of components and materials, it is necessary to observe the respective environmental protection and waste disposal regulations. In case of final unit liquidation, it is necessary to follow the policy of differential waste disposal. We recommend metal parts be scrapped and other parts be disposed of in accordance with separated waste regulations.
- Further information can be found in the AeroMaster Catalogue and in the AeroCAD designing software.
- Up-to-date version of this document is available at website [www.remak.eu](http://www.remak.eu)

# Air Handling units AeroMaster XP

## Application, Operating Conditions and Construction

### Manufacturer's Notification

AeroMaster air-handling units are manufactured in accordance with valid Czech and European regulations and technical standards. AeroMaster air-handling units must be installed and used only in accordance with this documentation. The installation and operating documentation must be available for the operating and servicing staff, and it is advisable to store this documentation close to the installed air-handling unit.

### Application and Operating Conditions

AeroMaster XP air-handling units are designed for comfortable air-handling and air-conditioning in an air flow range from 1,500 m<sup>3</sup>/h to 28,000 m<sup>3</sup>/h at air pressure difference of the fan of up to 2,500 Pa. AeroMaster XP air-handling units are intended for installation on the floor, and are delivered with a base frame mounted in the factory. They are designed to transport air without solid, fibrous, sticky, aggressive, respectively explosive impurities. The transported air must be free of corrosive chemicals or chemicals aggressive to zinc and steel, respectively aluminium.

Aeromaster XP air-handling units can be used in normal rooms (IEC 60364-5-51, resp. ČSN 33 2000-5-51 ed. 3, ČSN 33 2000-1 ed.2) and in rooms with extended ambient temperature range ranging from -30 °C to +40 °C without additional measures. When designing the air-handling assembly, it is necessary to take into account the temperature and humidity of the inlet and outlet air in relation to the ambient temperature and humidity. It is especially necessary to analyze the relation of the unit's casing classification pursuant to EN 1886 and the risk of condensation, respectively ice build-up. Degree of protection - IP 44. The unit's accessories (M & C) are not included - they must be assessed separately. The device can be used for outdoor installation if equipped with a protecting roof, the device is water spray proof (rain up to 60° vertical slant) while observing the Installation and Operating Instructions.

### Air-Handling unit Construction

The air-handling unit is designed as a modular system. The individual panels are connected by braces of 50 × 25 mm cross-section. The panels and braces are interconnected with screw joints - self-tapping hexagon-head screws 4,2×16 (DIN 7504-K) and plugs. It is recommended to use a magnetic screwdriver inner hexagon bit, size 7 (BN 31522, length 75 mm), to assemble and disassemble the panels.

Panels which are expected to enable occasional service access to the internal built-in assemblies are provided with grab handles to make handling easier. Selected sections are, for regular service purposes (replacement of filter inserts, cleaning of internal assemblies, etc), provided with inspection doors which are equipped with swivel locks. All panels are of sandwich construction with a total thickness of 50 mm. They are provided with a quality anti-corrosion surface finish. The panels are made of steel sheets - galvanized steel sheets (inner or outer panels), coated steel sheets (outer panels only), or stainless steel sheets (inner panels only). The thickness of the outer sheet is 1 mm and the thickness of inner sheet is 1 mm or 0.8 mm (galvanized side panels only).

Galvanized sheet steel material quality: galvanized sheet steel; continuous hot-dip galvanized EN 10 346 Z275 g/m<sup>2</sup>, corrosion resistance for C2 environment class as per EN ISO 14713. Painted sheet steel material quality: galvanized sheet steel - continuous hot-dip galvanized EN 10 346 Z275 g/m<sup>2</sup> + 25 m polyester paint, RAL 9002 EN10169 (corrosion resistance RC3), C2 environment class as per EN ISO 14713.

The panels are insulated with 50 mm thick fireproof mineral wool of 110 kg/m<sup>3</sup> density. The 12x3 self-adhesive sealing, temperature resistance from -40 °C to +80 °C and rate of volume absorption below 5%, is applied on the contact surfaces of panels. The joints are sealed with a silicone sealant of temperature resistance from -50 °C to +180 °C. The complete AeroMaster air-handling unit consists of sections. The section consists of the casing and built-in assemblies. The air-handling unit sections are assembled in the factory in so-called „transport-installation“ blocks.

### Air-Handling Unit Marking

Each section (except the frame) is provided with a type (name) plate indicating the following data (if applicable):

- Manufacturer's name
- Type, size and marking code of the section
- Order number and year of production
- Weight
- Power supply connecting data (electric distribution system)
- Degree of electric protection

### Side Variability of Unit Connections

The design of the AeroMaster unit enables you to combine the sides of the media supply connections and inspection door location. The connection side is determined according to the air flow direction (see figure #1).

**Figure 1** – Side variability of unit connections (plan view)

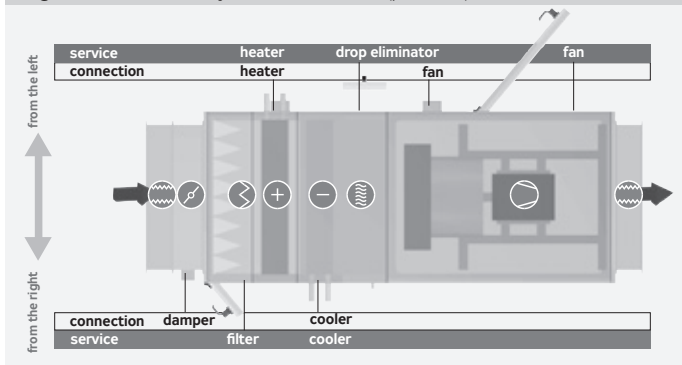

### Explanation of Symbols

- Elastic connection
- ⊗ Air damper
- ⊗ Air filter
- ⊕ Heater
- ⊖ Cooler
- ⊗ Drop eliminator
- ⊗ Fan

## Goods Despatch

Furthermore, the type plate includes the technical parameters of the given section. The user must ensure that every marking on the unit components will be readable and intact. If damaged, especially if safety is concerned, the marking must be repaired immediately.

### Information and Safety Labels

AeroMaster air-handling units, respectively individual sections, are labelled with information labels indicating equipment operation, wiring diagrams, energy media inlets and outlets, and information on the manufacturer.



The „Other Danger“ warning label situated on the face side of the service door indicates the hazard of catching by movable parts.



The service panel of the electric heater, wiring boxes and service panels covering other electrical equipment are labelled with a „Warning - Danger of Electric Shock“ label.

### Delivery Content

The following items are enclosed with every delivery of the air-handling unit:

- Accompanying technical documentation
- Commerce and technical documentation including air-handling unit assembly drawing.
- Connecting kit
- Installation kit
- Individual measurement and control components, respectively accessories in accordance with the bill of delivery.

### Transport and Storage

- Air-handling units without a base frame and air-handling units with a 150 mm high base frame are dispatched on a pallet.
- Air-handling units equipped with a 300 mm or 400 mm high base frame are dispatched without additional handling means.

- XPXB 17 and XPXB 22 sections of plate heat exchanger with a 150 mm high base frame are not dispatched on a pallet but are equipped with detachable legs instead. These should be disassembled prior to installation.

### Packaging

As standard, the transport blocks of the XP air-handling unit sections are packed in PE foil and provided with cardboard and polystyrene protecting guards. The holes in the base frame can be used to lift the unit by a crane.

### Transport and Handling of Air-Handling Unit Components

AeroMaster XP units are delivered to the installation site in the form of transport blocks of sections. The loading and unloading can be performed by a fork-lift truck or a crane.

If lifted by a crane, spacer bars must be inserted between the lifting wires to protect the unit from being damaged. If the unit section without a base frame is handled, fork-lift truck forks of a sufficient length must be used to overreach the full depth of the lifted section. If the unit section with a base frame is handled, forks of a sufficient length must be used to overreach both side beams of the base frame; an exception is the base frames (longer than 1000 mm) of the XP 17, 22 and 28 units, which are provided with a third inner beam. This beam is a supporting element of the base frame and can be used to lift the section if forks inserted from the rear side (i.e. non-servicing side) overreach the distance between the side and inner beams, i.e. 1065 mm (see figure # 4). The same design of the base frame is used for sections with overhanging service side (sections of electric and gas heaters, water heaters with covered feeds) and some selected sections of dimensional series XP 04-13.

When handling the units in the above described way, it is always necessary to check the centre of gravity (it must always be above the forks) by lifting the unit slightly.

### Warning:

When transporting, respectively handling the transport blocks of sections, it is necessary to pay increased attention to the parts (pipes, electric wiring elements) projecting from the sides of the transport block of the sections. All transport blocks of sections may be transported only in the same position as in which they are operated!

**For additional information on unloading the unit from a truck, refer to the chapter „Stacks of AeroMaster XP Air Handling Unit Sections“.**

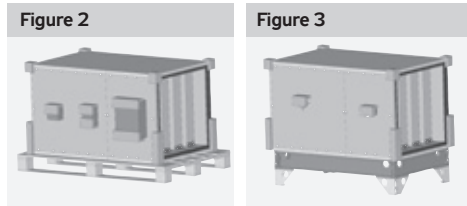
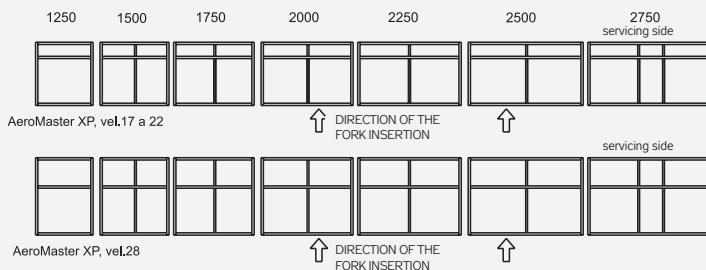

Figure 4 – Base frame arrangements



# Air Handling units AeroMaster XP

## Goods Despatch

Figure 5 – Base frame configuration

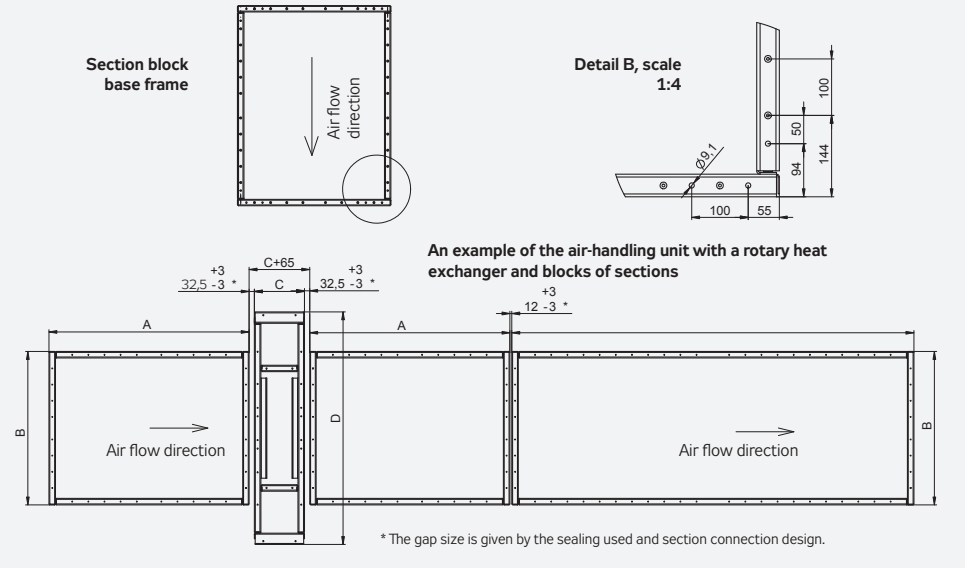

Table 1 – Frame dimensions

### Standard

Size	Width B	Section	Length A
XP 04	640	250	240
XP 06	790	500	490
XP 10	950	750	740
XP 13	1055	870	860
XP 17	1360	1000	990
XP 22	1360	1100	1090
XP 28	1665	1200	1190
		1250	1240
		1300	1290
		1350	1340
		1500	1490
		1560	1550
		1650	1640
		1750	1740
		1840	1830
		2000	1990
		2250	2240
		2500	2490
		2750	2740
		3000	2990

### Rotary heat exchanger (RHE)

Size	RHE	Width D	Length C
XP 04	770	876	310
	970	1086	310
XP 06	1070	1128	310
	1320	1380	310
XP 10	1320	1380	310
	1470	1360	310
	1670	1560	310
	1470	1360	310
XP 13 XP 17	1670	1560	310
	1820	1710	310
XP 22	2020	1905	340
	2220	2105	340
	2420	2305	340
XP 28	2020	1905	340
	2220	2105	340
	2420	2305	340

### Plate heat exchanger (parallel configuration)

Size	Width B	Length A
XP 04	1290	1240
XP 06	1590	1490
XP 10	1910	1640
XP 13	2120	1990
XP 17	2730	2240
XP 22	2730	2240
XP 28	3340	2590

## Installation

### Rotary Heat Exchanger Transport

Increased attention must be paid to the safety of persons as well as due to the product when handling the rotary heat exchanger, which due to its dimensions and high centre of gravity is very unstable. The manufacturer recommends fixing the position of the rotary heat exchanger by suitable roping always if it is not assembled in the section assembly! The rotary heat exchanger can only be stored, transported or handled in the vertical position. Any tilting may damage the rotor's evenness. If the section dimensions exceed the height of the truck, it is necessary to cover it with an additional tarpaulin.

All undivided rotary heat exchangers with a rotor diameter greater than 1800 mm will be equipped with numbered tilt and impact detectors registered by the manufacturer. The integrity of these indicators is a condition for the guarantee to stay valid.

Figure 6 – Handling options



### Storage Conditions

As standard, the air-handling units are packed in PE foil. They must be stored in indoor rooms complying with the following conditions:

- Maximum relative air humidity must not exceed 85 %.
- No moisture condensation
- Ambient temperature must be in the range from -20 °C to +40 °C.
- The air-handling unit must be protected against penetration of dust and caustic vapours, or other chemical substances which could cause corrosion of the air-handling unit's structural components.
- The air-handling unit must not be exposed to the direct effects of solar radiation.
- Sections of air-handling units may be stored only in the position identical to their working position.

### Stacking

Only transport blocks of sections of the AeroMaster XP 04, 06, 10, 13 series are allowed to be stacked providing the following rules are observed:\*

1. Only two sections may be stacked upon each other.
2. The section placed on the upper row must be without the base frame.
3. The section placed on the upper row must not overlap in any direction the one on the lower row.
4. Protective elements must be inserted between stacked sections to protect them against damage.
5. The fan section must always be situated below.
6. Plate and rotary heat exchangers cannot be stacked.

### Installation Site

The surface of the site for the air-handling unit installation must be levelled and flat. Maximum misalignment of the floor or supporting structure intended for the air-handling unit installation must not exceed 1 mm per 1 meter. This maximum misalignment must also be retained if installing air-handling units equipped with base frames with adjustable feet (for the adjustment procedure, refer to „AeroMaster XP Air-Handling Adjustable and fixed Feet“). Observance of this condition is important for installation as well as for the air-handling unit operation. The air-handling unit equipped with an integrated base frame does not need any special anchoring. It is advisable to ground the air-handling unit with grooved rubber stripes. When installing the rotary heat exchanger, it is necessary to retain the frame's rectangularity, which influences the volubility of the rotor and leak tightness of the section. When installing the gas heater section, it is necessary to retain safety distances from inflammable materials in accordance with national directives and standards of the state of installation (in CZ - ČSN 06 1008). No inflammable materials are allowed to be stored within the area of the gas heater section installation.

Figure 7 – Service access

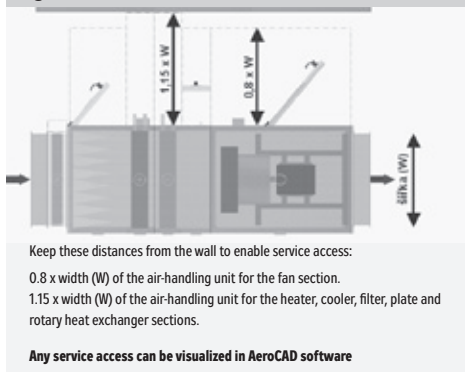

### Service Access

When planning the air-handling unit location, it is necessary to keep in mind sufficient space for maintenance, service and operating. The need for this space depends on the air-handling unit configuration, i.e. on the operational sections used.

### Pre-Installation Inspection

Prior to installation, the following must be checked:

- Intactness of the delivery (completeness according to the bill of delivery)
- Volubility of rotary components (fans, dampers, rotary heat exchanger)
- Parameters of power supply and connected energy media sources
- Any found fault must be removed before starting the installation.

\* For additional information on unloading the unit from a truck, refer to the chapter „Stacks of AeroMaster XP Air-Handling Unit Sections“

## Installation

### Identification of Air-Handling Unit Components

The association of sections to the purchase order number is indicated on the type plate of each section, i.e. device number and position number of the section. The first double digit indicates association with a particular device of the given purchase order. The second double digit indicates the position of the section within the device. All sections bearing the same device number create an air-handling unit. The arrangement of the sections within the unit is indicated by the position numbers on the printed assembly lay-out, which is a part of the delivery, see figure # 8.

**Figure 8** – Identification of components

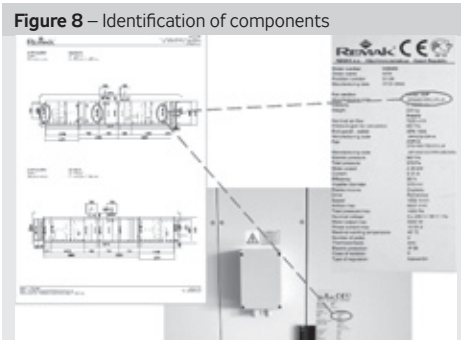

### Assembly of Air-Handling Unit Sections

The air-handling unit sections can be assembled together by connecting their base frames and connecting the respective sections.

#### Connection Procedure:

1. Apply rubber sealing (19x4) to the contact surfaces of the connecting frame.
2. Push the connected sections together.
3. Using adjustable legs or elastic pads, align the height of the sections (see the chapter Location).
4. Use M10x120 screws and connect the base frames to secure the relative position of the sections.
5. Carry out the air-tight connection of the sections.

**Depending on the air-handling unit type, there are three types of section connections:**

#### Using the 25x25 profile connecting frame

Each connection of sections consists of one frame fitted with fixed nuts and one frame with through holes for M6x40 screws (see figure 9). To be able to screw the sections through the connecting frame profiles, it is necessary to remove the side panels on the side of the frame with through holes (using the magnetic screwdriver adaptor from the installation kit - the screws are embedded in the panels), or open the service panels with locks. The fixed connection is completed using corner irons secured with M10x25 screws (see figure 10).

#### Using the XPSSSxxDR connecting kit

Each section connection is fitted with connecting nodes with a labyrinth system which sets the sections at the correct relative positions (see figure 38). It is located either in vertical profiles (XP 10-13) or in all four sides (XP17-28) of the connecting frame and there is no need to remove the side panels. The fixed connection is completed using corner irons secured with M10x25 screws (see figure 10).

#### 25x50 profile connecting frame

Each section connection is created by the same profiles with through holes for special screws (for the installation procedure, see page 45). The connection is accessible from inside the unit and there is no need to remove the side panels.

To be able to screw the sections through the connecting frame profiles, it is necessary to remove the side panels (using the magnetic screwdriver adaptor from the installation kit - the screws are embedded in panels) or open the service panels with locks. Independently working sections and air inlet/outlet sections without a heat recovery device can be assembled horizontally or vertically - max. in two rows. If this is the case, their additional connection is necessary (e.g., screwing them together through their inner casing). If vertically arranged sections are of different sizes, the service sides must be flush.

**Note: For information on connecting individual sections using the XPSSSxxDR complementary set, refer to page 26.**

For the recommended installation procedure for frame adjustable or fixed feet, refer to the appendix to this document. Independently working sections and air inlet/outlet sections without a heat recovery device can be assembled horizontally or vertically - max. in two rows. If this is the case, their additional connection is necessary (e.g., screwing them together through their inner casing). If vertically arranged sections are of different sizes, the service sides must be flush.

**Figure 9** – Connection of frames and connection of sections using corner irons

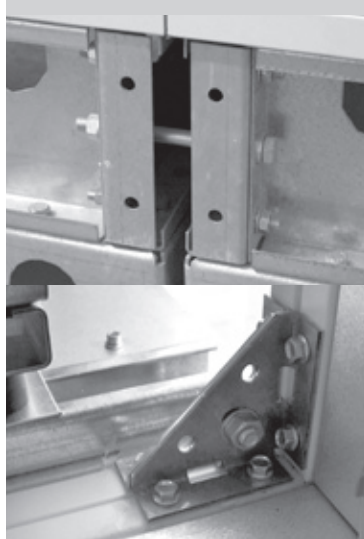



## Installation

### Installation of Covering Roof

An air-handling unit installed outside must be protected by a covering roof against water penetration. Below, you will find the installation procedure for the joint-less covering roof equipped with weather moulding, which is delivered as an accessory.

First, spread all the individual parts out in a free area. Images including precise locations of covering roofs are included in the accompanying technical documentation delivered with each air-handling unit. The covering roof consists of individual partial roofs and connecting bars, and also covers the cross joint if the air inlet and outlet are situated in a parallel position. As standard, the covering roofs delivered are made of galvanised (Z275 g/m<sup>2</sup>) sheet or galvanised sheet with a RAL 9002 polyester coating. Other designs of covering roofs can be delivered upon agreement with the manufacturer.

#### Material needed for the covering roof installation:

- Sealant (included in the delivery)
- Roof screws 6.5 x 18 (included in the delivery)
- Pliers (min. opening of 35 mm)

#### Installation procedure:

- First, following the attached assembly lay-out, lay out individual parts of the covering roof and centre them on their intended spot.
- Begin the installation by fixing one specific roof (e.g. the roof with opening, rotary heat exchanger roof, or electric or water heater roof, etc). Before installing the next section of the roof, it is necessary to apply silicone sealant on the contact surfaces of the adjoining roofs (see figure # 11).
- After finishing the roof installation, apply a second protective layer of silicone sealant on all joints (see figure # 11).
- Any gap and/or joint leakage (corners, open faces of protecting mouldings, incl. grooves, cross-butt joint, etc.) must be sealed with silicone sealant. Then, fix and seal the covers of the cross-butt joint (see figure # 13).
- Make the roof completely waterproof by sealing the bottom side of the roof and the top edge of the side panel (see figure # 14).

Figure 10 – Sealing of roof elements

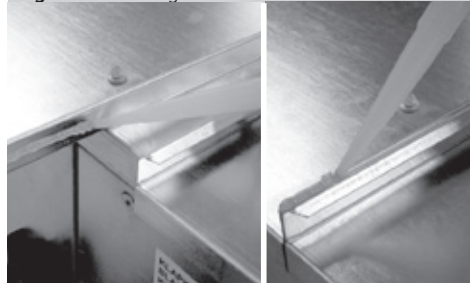

Figure 11 – Covering of roof joints

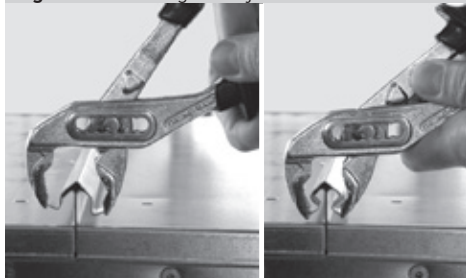

Figure 12 – Cross-butt joint sealing

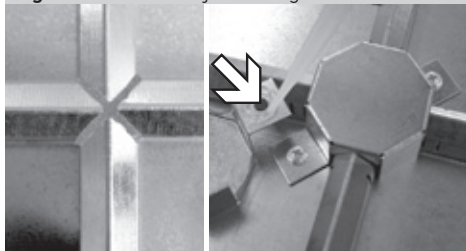

Figure 13 – Sealing of the panel edges





## Installation

### Plate Heat Exchanger

Figure 14

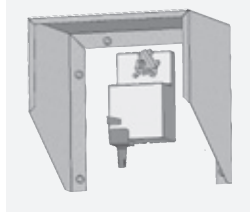

The XPXK plate heat exchanger sections intended for outdoor installation must be equipped with a covering roof for the actuator; this covering roof including connecting material is included in the delivery.

#### Plate Exchanger Frame Installation

The plate heat exchangers for dimensional series XPXK 22 and 28 with a 400 base frame are delivered with a

divided base frame. The 150 mm base frame is attached to the plate heat exchanger section while the other parts („feet“) of the base frame, including connecting material, are attached separately to the delivery. For „feet“ installation, refer to „AeroMaster XP Air-Handling Unit Adjustable and fixed Feet“..

### Rotary Heat Exchanger

#### Attention!

During installation, it is ESSENTIAL to retain alignment of the AeroMaster XP unit and rectangularity of the heat exchanger. Failing to maintain the above-mentioned condition will result in rotor displacement, which will influence the tightness and service life of the air-handling assembly. It is advisable to connect one side of the heat exchanger to the assembly first and then check the rotor alignment (the distance between the wheel circumference and face walls must be aligned and the rotor must not drag in any position when freely rotated).

If any problems occur, wheel centring must be performed (contact the manufacturer's service department). After positioning the rotary heat exchanger, push the sealing brushes in the dividing plane against the rotor.

#### Rotary Heat Exchanger Positioning and Installation

The rotary heat exchangers for dimensional series XP 10 and above are always equipped with a 150 mm base frame. If 300 mm or 400 mm base frames are used with the installed unit, it will be necessary to install a separate foot on the base frame to eliminate the height difference (see figure # 15).

Figure 15

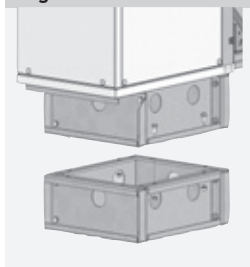

#### Attention!

A rotary heat exchanger is one of the most expensive components in the air-handling assembly; poor and/or incorrect installation can result in costly repairs. Misalignment can be caused by improper handling during transport and/or failing to observe conditions for its correct installation. If the misalignment prevents free rotation of the rotor, the rotor will have to be centred using a centre screw. If this is the case, contact the manufacturer of the air-handling device. To check the heat exchanger rotor fouling, it is necessary to perform regular monitoring of the heat exchanger rotor pressure loss. The heat exchanger rotor pressure loss must not exceed 15% of the pressure loss value measured on a new rotary heat exchanger. To enable regular service, maintenance, guarantee and post-guarantee service, it is necessary to provide service access from both sides of the heat exchanger's rotor. If this is not enabled by the air-handling unit assembly arrangement, the air-handling assembly must be designed so that the heat exchange can be pushed out from the air-handling assembly.

### Heating and Cooling Media Feeds

All media feeds are connected to the outer side of the air-handling unit. The internal interconnection is made during production in the factory. The corresponding connection points are marked with labels (see figure # 17).

Figure 16 – Heating and cooling media feed



## Connection of Heat Exchangers

### Water and Glycol Heat Exchangers

The connections of heating and cooling media feeds must be performed so that no forces arising from the dilatation and weight of feeding pipes and fittings will be transferred to the air-handling unit. The corresponding connection points are marked with labels on the unit side panel (heating water inlet, heating water outlet, coolant inlet, coolant outlet).

As standard, water heater exchangers are equipped with air self-venting 1/2" TACO valves, which are situated on top sides of both headers.

**Table 2** – dimensions of water heat exchangers

Dimensional series	Connection of VO 1–4 rows	Connection of VO 5–8 rows
XP 04	G 1"	G 1"
XP 06	G 1"	G 1"
XP 10	G 1"	G 2"
XP 13	G 1,5"	G 2,5"
XP 17	G 1,5"	G 2,5"
XP 22	G 2"	G 3"
XP 28	G 2"	G 3"

### Connection of Water Heat Exchangers

The counter-current connection of the heat exchangers is necessary to achieve maximum output. When connecting the feeding fittings to the heat exchangers, use two wrenches to tighten the screws to avoid twisting of the exchanger's headers.

**Figure 17** – Heat exchanger connection

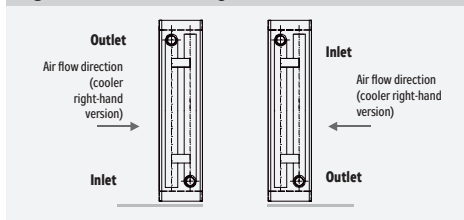

**Table 3** – dimensions of direct evaporators

Series	Number of rows	Inlet 1 (1/2)	Inlet 2 (1/2)	Outlet 1 (1/2)	Outlet 2 (1/2)
XP 04	2R	12	–	16	–
	3R	16	–	22	–
	4R	12	12	16	16
XP 06	2R	16	–	22	–
	3R	22	–	28	–
	4R	12	16	16	22
XP 10	2R	16	–	22	–
	3R	16	–	28	–
	4R	12	16	16	22
XP 13	2R	16	–	22	–
	3R	12	16	16	22
	4R	12	22	16	28
XP 17	2R	22	–	28	–
	3R	16	16	22	28
	4R	16	16	22	28
XP 22	2R	28	–	35	–
	3R	16	22	22	28
	4R	22	28	28	35
XP 28	2R	28	–	35	–
	3R	16	22	22	28
	4R	22	28	28	35

Connecting fittings of sections with covered feeds must be insulated and suitable grommets or sealing must be used to seal the passages through the unit's casing.

Heating or cooling media can be led to the heat exchanger through the lower panel (universal) or through removable side panels (depending on the air-handling assembly, respectively if it is enabled by the adjacent sections and service access), see figure #18. The lay-out of the openings can be selected according to the mixing set version and overall dimensions.

**Figure 18** – Exchangers with covered feeds

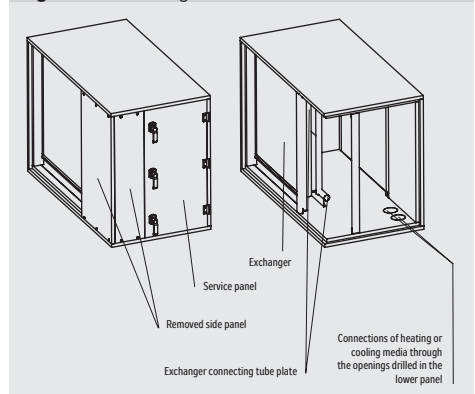

After connecting the water heat exchangers (heaters and coolers, including mixing sets) to the distributing piping, it is necessary to pressurize (flush with water) and vent the entire circuit, including the heat exchanger, and then to perform leak-tightness checks of all pipe joints and of the exchanger itself (including checking the interior of the water exchanger section).

The manufacturer does not provide any guarantee covering any damage resulting from liquid leakage from leaky joints or damaged exchangers.

### Direct Evaporators

Direct evaporators must be connected by a specialized contractor authorized to install refrigerating equipments. The direct evaporators are filled with nitrogen in the production factory.

#### Note:

Due to the aggressive environment inside the unit, the capillary probes (CAP) for swimming-pool units are always installed on the external side of the unit.

### Steam humidification

For a detailed description of the installation, commissioning and prescribed inspections of the steam humidification section, refer to the separate manual which is a part of the accompanying documentation of the AeroMaster XP air-handling unit. When installing the steam humidification section, observe the following recommendations:

- Air ducts led through cold areas must be insulated to avoid condensation.
- The steam humidification assembly must be situated in a non-freezing area.
- The steam generator can be noisy (switching of solenoid valves). Therefore, it is advisable to install it away from quiet areas

## Connection of Heat Exchangers

- **100 °C hot and heavily mineralized water is drained from the steam humidifier.**
- **The following minimum distances** (distances between the steam humidifier and the following air-handling unit components, where H represents the minimum evaporating distance calculated for the given conditions) must be observed to ensure proper operation of the steam humidifier and the entire AeroMaster XP air-handling unit:
  - Humidistat piping, humidity sensor, temperature sensor: 5 x H
  - Very fine filter: 2.5 x H
  - Heating elements, filter: 1.5 x H
  - Duct branch piece, duct elbow, air outlet, fan: 1 x H

*Note: If the  $e_{p,H}$  value is not known, it is advisable to make the calculation with a minimum value of 1.0 m.*

**Figure 19** – Connection of evaporators

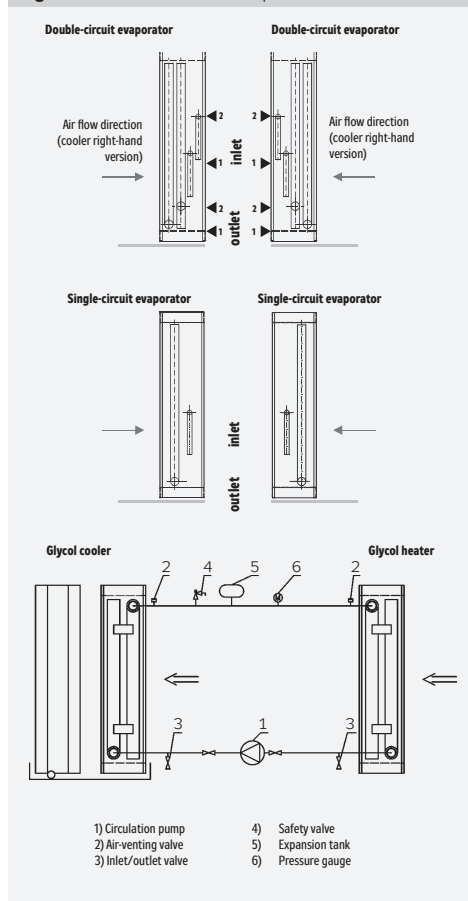

**Table 4** – External connecting dimensions of direct evaporators in mm (1/2 : 1/2 connections)

Series	Number of rows	Inlet 1 (1/2)	Inlet 2 (1/2)	Outlet 1 (1/2)	Outlet 2 (1/2)
XP 04	2R	12	—	16	—
	3R	16	—	22	—
	4R	12	12	16	16
	5R	12	12	22	22
	6R	12	12	22	22
	7R	12	12	22	22
XP 06	2R	16	—	22	—
	3R	22	—	28	—
	4R	16	16	22	22
	5R	22	22	28	28
	6R	22	22	28	28
	7R	22	22	28	28
XP 10	2R	22	22	28	28
	3R	22	22	28	28
	4R	16	16	22	22
	5R	12	12	22	22
	6R	22	22	28	28
	7R	22	22	28	28
XP 13	2R	22	22	28	28
	3R	22	22	28	28
	4R	16	16	28	28
	5R	22	22	28	28
	6R	22	22	28	28
	7R	22	22	28	28
XP 17	2R	35	35	42	42
	3R	22	—	28	—
	4R	16	16	28	28
	5R	22	22	28	28
	6R	22	22	28	28
	7R	22	22	28	28
XP 22	2R	22	22	28	28
	3R	28	—	35	—
	4R	28	28	35	35
	5R	22	22	28	28
	6R	28	28	35	35
	7R	28	28	35	35
XP 28	2R	28	28	35	35
	3R	22	22	28	28
	4R	28	28	35	35
	5R	28	28	35	35
	6R	28	28	35	35
	7R	28	28	35	35
XP 28	8R	35	35	42	42

## Condensate Drainage

Cooling, plate heat exchanger and steam humidification sections are equipped with stainless condensate draining trays which terminate in an outlet for the condensate draining kit connection. The condensate draining kits are available as optional accessories. Dimensional ranges from XP04 to XP10 are terminated in a G1/2" thread, and dimensional ranges from XP13 to XP28 are terminated in a tube of  $\varnothing 32$  mm. A separate condensate draining kit must be used for each individual section. The siphon height depends on the total pressure of the fan, and ensures its proper functioning. The type of condensate draining kit must be designed in the course of the air-handling unit calculation. The condensate draining piping must end in a free atmosphere, i.e. it must not end directly in the closed sewerage system. Before operating the air-handling unit or after being out of operation for a longer period, it is necessary to fill the siphon via the plastic plug with water.

## Other Connections

**Figure 20 – Condensate draining**

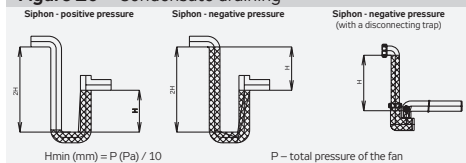

The air-handling unit can also be equipped with a siphon with a disconnecting trap and a ball valve (only negative pressure sections). This type of siphon need not be filled with water before putting it into operation.

If there is a risk of freezing, it is necessary to insulate the siphon and condensate draining piping, respectively keep the ambient temperature above freezing point, e.g. with an electric heating cable! The gas heater section is provided with a condensate draining outlet (1/2" pipe) to drain the condensate from the combustion chamber.

### Air-Handling Duct Connection

The air ducting must be connected to the air-handling unit via an elastic element to avoid the transfer of vibrations and eliminate the misalignment of the duct and inlet of the air-handling unit. The connection must be performed so that no loading from the air duct will be transferred to the inlet panel of the air-handling unit and no deformation of this panel will be possible.

The accessories must be installed in accordance with the air-handling unit specification and Installation Instructions of the manufacturers of such accessories.

No other structures must obstruct the unit inspection door opening, or unit operating and maintenance.

**Figure 21 – Air-handling duct connection**

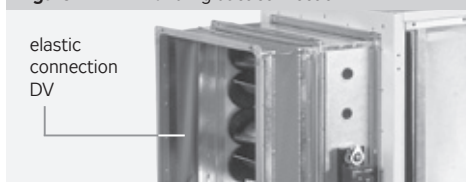

### Electrical Equipment Wiring

The external connection of the internal electrical equipment of the air-handling unit can be made via wiring the terminal boxes which are situated on the outer side of the air-handling unit (the service side according to the designer's specification). The internal electrical equipment of the air-handling unit has already been connected to the terminals of these wiring terminal boxes. The wiring and installation of the M&C system elements must be performed by qualified professionals authorized to perform wiring of the given type of device. The wiring must be performed in accordance with directives and standards of the state of installation, and in accordance with the Installation and Operating Instructions of individual pieces of equipment (frequency converters, pressure and temperature sensors, etc). Before putting the air-handling unit into operation, a wiring inspection must be performed.

Before starting the wiring, check the following:

- Conformity of the power supply parameters with the data on the type plate of the connected section.
- Cross-sections of connecting cables.

### Wiring of Motors

The motors are equipped with thermo-contacts which protect them against overheating. The thermo-contacts must be connected as shown in the wiring diagram. The service switch (delivered as an optional accessory separately) is not installed on the unit. The service switch connection must be performed in accordance with directives and standards of the state of installation, and in accordance with the Installation and Operating Instructions.

The service switch (delivered as an optional accessory) serves to disconnect the fan from the power supply and from voltage supplied to the TK thermo-contacts. It prevents unintentional start-up and presence of voltage on the TK terminals when performing maintenance.

**This switch is not a substitute for the main or emergency switches.** After switching the service switch on again, it is necessary to check the state of the STE and STD relays, respectively, of the parent control system, and reset the failure of the TK thermo-contacts caused by disconnecting the service switch.

**Warning: When performing any maintenance or repairs, the device must always be disconnected from the power supply!**

#### Single-Speed Motors

- Rated voltage and wiring for asynchronous motors up to 3 kW: 230 VD / 400 VV
- Rated voltage and wiring for asynchronous motors above 3 kW: 400 VD / 690 VV
- The motors are connected in the factory to the wiring terminal boxes situated on the external casing of the fan sections. As standard, they are designed for a power supply of 3x 400 V / 50 Hz. The motor can be optionally delivered for a frequency of 60 Hz.
- **Warning:** If you are considering connecting the air-handling unit to a 60 Hz power supply system, it is necessary to check whether the parameters of the air-handling unit have been designed for this frequency. If the delivery contains an output controlling frequency converter Danfoss, FC051 series, degree of protection IP21 for motors up to 0.75 kW (included), the power supply for the frequency converter (input) will be 1 x 230 V/50 Hz (while the frequency converter output will be 3 x 230 VVD). Power supply for motors with power output above 1.5 kW equipped with FC051 series frequency inverters, IP21 and motors equipped with FC101 series frequency inverters is 3 x 400V/50 Hz. If the single-speed motor is additionally equipped with an output controller (frequency converter) it is necessary to check, respectively reconnect, the motor wiring (the correct connection in the motor terminal box is Y/D) in accordance with the input voltage (230/400V).

#### Two-Speed Motors

- 6/4 pole motors - two separate windings Y/Y (output, respectively speed ratio 2:3)
- 4/2 and 8/4 pole motors - Dahlander D/YV (output, respectively speed ratio 1:2)
- The two-speed motors are connected to the wiring terminal boxes situated on the external casing of the fan sections. The rated motor voltage for 1st and 2nd speed stage is 3 x 400 V / 50 Hz. Before starting the wiring, it is necessary to look for the appropriate wiring diagram further in this manual corresponding with the data on the type plate.

# Air Handling units AeroMaster XP

## Other connections

### Schemes of electric wiring – motors of fans

#### Three-phase asynchronous motor with thermistors

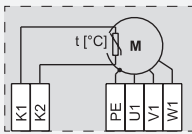

**U1,V1,W1,PE**  
- clamps of triple-phase motor power supply, 3f-400V/50Hz  
**K1, K2**  
- thermistor clamps

#### Three-phase asynchronous two-speed motor with thermistors

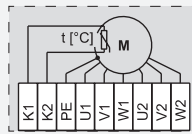

**U1,V1,W1,PE**  
- clamps of 1. winding of triple-phase double speed motor power supply, 3f-400V/50Hz (s. 1)  
**U2,V2,W2**  
- clamps of 2. winding of triple-phase double speed motor power supply, 3f-400V/50Hz (s. 2)  
**K1, K2**  
- thermistor clamps

#### Three-phase EC motor

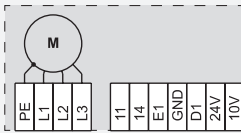

**PE, L1, L2, L3**  
- power supply clamps of the triple-phase motor 3f-400V/50Hz  
**11, 14** - fan summary fault  
**E1** - DC input  
**D1** - digital input (on/off)  
**24V** - 24 V DC voltage source  
**10V** - 10 V DC voltage source  
**GND** - ground

#### Three-phase PMBlue motor

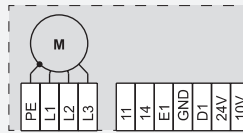

**PE, L1, L2, L3**  
- power supply clamps of the triple-phase motor 3f-400V/50Hz  
**11, 14** - fan summary fault  
**E1** - DC input  
**D1** - digital input (on/off)  
**24V** - 24 V DC voltage source  
**10V** - 10 V DC voltage source  
**GND** - ground

#### Single-phase asynchronous motor with thermistors

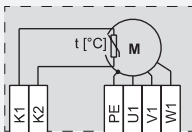

**U1, U2, PE**  
- switzy napájení jednofázového motoru 1f-230V/50Hz  
**K1, K2**  
- thermistor clamps

#### Single-phase EC motor up to 10 poles

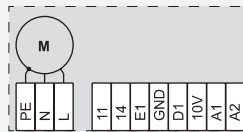

**PE, N, L**  
- power supply clamps of the single-phase motor 1f-230V/50Hz  
**11, 14** - fan summary fault  
**E1** - DC input  
**D1** - digital input (on/off)  
**24V** - 24 V DC voltage source  
**10V** - 10 V DC voltage source  
**GND** - ground  
**A1** - output of the tachogenerator - operation  
**A2** - tachogenerator - state

#### Single-phase EC motor with 10 poles

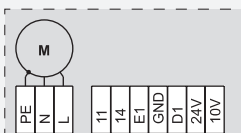

**PE, N, L**  
- power supply clamps of the single-phase motor 1f-230V/50Hz  
**11, 14** - fan summary fault  
**E1** - DC input  
**D1** - digital input (on/off)  
**24V** - 24 V DC voltage source  
**10V** - 10 V DC voltage source  
**GND** - ground

#### Single-phase asynchronous motor (up to 0.75 kW) with thermistors

controlled by the single-phase Danfoss FC051 frequency inverter, IP21, (up to 0.75 kW), Modbus

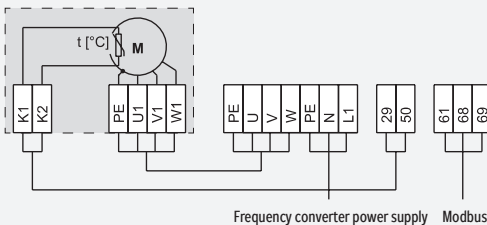

**U1, V1, W1, PE1**  
- power supply clamps of the triple-phase single speed motor 3ph-400V/50Hz  
**K1, K2**  
- thermistor clamps  
**L1, N, PE**  
- clamps of single-phase frequency inverter power supply 1ph-230/50Hz  
**29, 50**  
- frequency inverter terminals for the motor's thermo-contact (TK) connection  
**61, 68, 69**  
- Modbus terminals

Frequency converter data settings have been set by the manufacturer

## Other connections

### Single-phase asynchronous motor (up to 0.75 kW) with thermistors

controlled by the three-phase frequency inverter (except Danfoss FC051 frequency inverter, IP21, (up to 0.75 kW), Modbus)

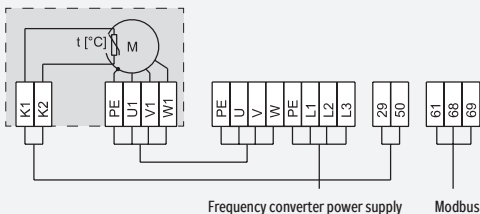

- U1, V1, W1, PE1**  
- power supply clamps of the triple-phase single speed motor 3ph.-400V/50Hz  
**K1, K2**  
- thermistor clamps  
**PE, L1, L2, L3**  
- power supply clamps of the triple-phase frequency inverter 3f-400V/50Hz  
**29, 50**  
- frequency inverter terminals for the motor's thermo-contact (TK) connection  
**61, 68, 69**  
- Modbus bus terminals  
*Frequency converter data settings have been set by the manufacturer*

## Rotary Heat Exchangers

### XPFM Control

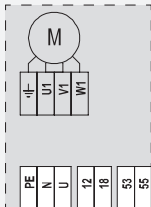

- U, PE, N**  
- clamps for power supply of rotary heat exchanger controlled by frequency converter 1f-230/50Hz  
**53, 55**  
- clamps for connection of control signal 0-10V DC  
**12, 18**  
- clamps for connection of non-potential contact for heat exchanger switching  
**U1, V1, W1**  
- clamps for motor connection (standardly connected)

### Without control

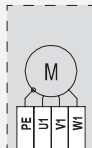

- U1, V1, W1, PE**  
- clamps of rotary heat exchanger power supply 3f-400V/50Hz

## Electric heaters

### Electric heater XPNE .../..X P= 12-45 kW

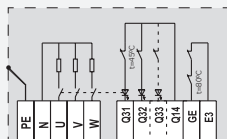

- U, V, W, N**  
- clamps of electric heater power supply, 3f-400V/50Hz  
**PE**  
- clamp for safety conductor  
**Q 31, Q 32, Q 33, Q 14**  
- clamps for el. heater EOSX output control (sections switching) 24V DC  
**E3, GE**  
- clamps of safety thermostat

### Electric heater XPNE .../..X P= 60-75 kW

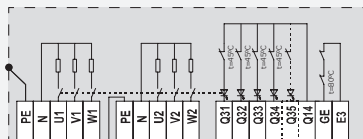

- U1, V1, W1**  
- clamps of first power supply of electric heater, 3f-400V/50Hz  
**PE**  
- clamp for safety conductor  
**PE, N, U2, V2, W2**  
- clamps of second power supply of electric heater, 3f-400V/50Hz  
**Q 31, Q 32, Q 33, Q 34, Q 35, Q 14**  
- clamps for el. heater EOSX output control (sections switching) (24V DC)  
**PE, N, E3, GE**  
- clamps of safety thermostat

### Electric heater XPNE .../..X

P= 90-126 kW

### Electric heater XPNE .../..S

P= 12-45 kW

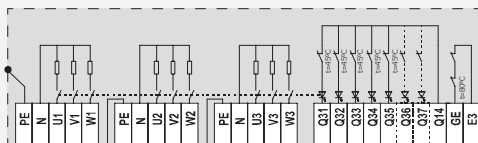

- U1, V1, W1, PE, N**  
- clamps of first power supply of electric heater, 3f-400V/50Hz  
**U2, V2, W2, PE, N**  
- clamps of second power supply of electric heater, 3f-400V/50Hz  
**U3, V3, W3, PE, N**  
- clamps of third power supply of electric heater, 3f-400V/50Hz  
**E3, GE**  
- clamps of safety thermostat  
**PE**  
- clamp for safety conductor  
**Q 31, Q 32, Q 33, Q 34, Q 35, Q 36, Q 37, Q 14**  
- clamps for el. heater EOSX output control (sections switching) (24V DC)

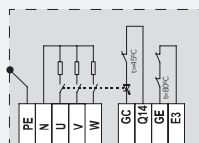

- U, V, W, PE, N**  
- clamps for electric heater power supply, 3f-400V/50Hz  
**E3, GE**  
- clamps of safety thermostat  
**Q14, G1, G2, G3, G4**  
- clamps for electric heater switching (24V DC)

# Air Handling units AeroMaster XP

## Other connections

### Electric heater XPNE ../..S

P= 60-75 kW

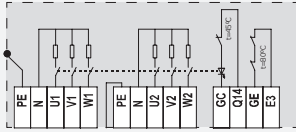

- U1,V1,W1,PE,N**  
- clamps of first power supply of electric heater. 3f-400V/50Hz
- U2,V2,W2,PE,N**  
- clamps of second power supply of electric heater. 3f-400V/50Hz
- E3,GE**  
- clamps of safety thermostat
- Q14,GC**  
- clamps of electric heater switching (24V DC)

### Electric heater XPNE ../..S

P= 90-126 kW

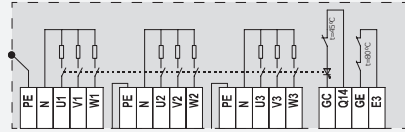

- U1,V1,W1,PE,N**  
- clamps of first power supply of electric heater. 3f-400V/50Hz
- U2,V2,W2,PE,N**  
- clamps of second power supply of electric heater. 3f-400V/50Hz
- U3,V3,W3,PE,N**  
- clamps of third power supply of electric heater. 3f-400V/50Hz
- E3,GE**  
- clamps of safety thermostat
- Q14,GC**  
- clamps of electric heater switching (24V DC)

### Electric heater XPNE ../..

P= 12-45 kW

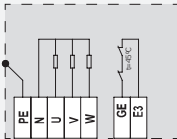

- U,V,W,PE,N**  
- clamps of electric heater power supply. 3f-400V/50Hz
- E3,GE**  
- clamps of safety thermostat

### Electric heater XPNE ../..

P= 60-75 kW

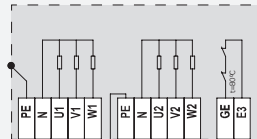

- U1,V1,W1,PE,N**  
- clamps of first power supply of electric heater. 3f-400V/50Hz
- U2,V2,W2,PE,N**  
- clamps of second power supply of electric heater. 3f-400V/50Hz
- E3,GE**  
- clamps of safety thermostat

### Electric heater XPNE ../..

P= 90-126 kW

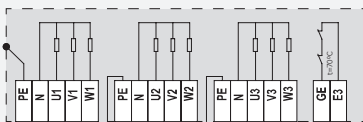

- U1,V1,W1,PE,N**  
- clamps of power supply for first section of electric heater. 3f-400V/50Hz
- U2,V2,W2,PE,N**  
- clamps of power supply for second section of electric heater. 3f-400V/50Hz
- U3,V3,W3,PE,N**  
- clamps of power supply for third section of electric heater. 3f-400V/50Hz
- E3,GE**  
- clamps of safety thermostat

## Dimensioning the electrical heater power supply terminals

Type	Output PC [kW]	Output 1 P1 [kW]	Output 2 P2 [kW]	Output 3 P3 [kW]	Supply terminals – cross section in mm <sup>2</sup>		
					U1,V1,W1 <sup>*)</sup>	U2,V2,W2 <sup>*)</sup>	U3,V3,W3 <sup>*)</sup>
XP04	12	12			6		
XP04	24	24			10		
XP04	36	36			16		
XP06	15	15			6		
XP06	30	30			16		
XP06	45	45			25		
XP10	15	15			6		
XP10	30	30			16		
XP10	45	45			25		
XP10	60	24	36		10	16	
XP13	30	30			16		
XP13	45	45			25		
XP13	60	24	36		10	16	
XP13	75	45	30		25	16	
XP17	42	42			25		
XP17	60	24	36		10	16	
XP17	72	36	36		16	16	
XP17	90	36	36	18	16	16	6
XP22	60	24	36		10	16	
XP22	72	36	36		16	16	
XP22	90	36	36	18	16	16	6
XP22	108	36	36	36	16	16	16
XP28	63	36	27		16	16	
XP28	72	36	36		16	16	
XP28	90	36	36	18	16	16	6
XP28	108	36	36	36	16	16	16
XP28	126	54	36	36	25	16	16

\* U, V, W in case of single inlet



## Start-Up Preparation and Commissioning

### Commissioning

The air-handling unit may be commissioned only by a properly qualified person. Prior to first start-up of the air-handling unit, an inspection of the wiring of all connected components of the air-handling unit must be performed by a qualified technician.

### Safety Measures

- The sections which can generate some injury hazards (electric shock, rotating parts, etc.) or connection points (heating water inlets/outlets, air flow direction, etc.) are always labelled with warning or information labels.
- It is forbidden to start the fans of the air-handling unit if the panels are open or removed. The hazard of trapping by movable parts is indicated by a label situated on the service door of the air-handling unit. Service doors must always be closed during air-handling unit operation and the lockable closure of the fan chambers must be locked with a key to prevent unauthorised access.
- Before starting any work on the fan section, the main switch must always be turned off and secured to avoid accidental starting of the motor during service work on the fan section.
- When emptying the heat exchanger, the water temperature must be below +60 °C. The connecting piping of the heater must be insulated so its surface temperature will not exceed +60 °C.
- It is forbidden to remove the service panel of the electric heater if energized, or to change the factory settings of the safety thermostat.
- It is forbidden to operate the electric heater without the outlet air temperature control and without ensuring the steady flow of transported air.
- Controlled run-down of the fans must be ensured upon the gas heater section shut-down to avoid the exchanger overheating, and simultaneously, the outlet air temperature behind the gas heater, respectively ambient temperature of the burner, must not exceed 40 °C.
- After being set by the expert, the parameters of the gas heater must stay unchanged to maintain safe and trouble-free operation.

### Inspection Prior to First Start-Up

#### General Checks

- The service panels are provided with hinges and external closures. The closure simultaneously serves as a handle. A special tool - a wrench - is needed to open/close the closure.
- Check alignment of the air-handling unit  
Check whether all components of the air-handling unit are installed and connected to the air distributing ducting.
- Check whether all cooling and heating circuits are connected, and whether energy media are available.
- Check whether all electrical appliances are connected.
- Check whether all condensate draining kits are connected.
- Check whether all M&C components are installed and connected

#### Electric Wiring

- Check the proper wiring of all individual electrical components of the air-handling unit according to the corresponding wiring diagrams.

#### Filter Sections

- Check the condition of filters.
- Check the fixation of filters.
- Check the settings of differential pressure sensors

### Water and Glycol Heater Sections

- Check the condition of the heat-exchange surface.
- Check the condition of the inlet and outlet piping.
- Check the condition of the mixing set.
- Check the condition, connection and installation of antifreeze protection components.

### Electric heater Section

- Check the condition of the heating coils.
- Check the connection of the heating coils
- Check the connection of the emergency and operating thermostats.

### Sections of water/Glycol heaters, Direct evaporators

- Check the condition of the heat-exchange surface.
- Check the condition of the inlet and outlet piping.
- Check the connection of the condensate drainage.
- Check the connection and elements of the cooling circuit.
- Check the condition of the drop eliminator dampers.

### Plate Heat Exchanger Section

- Check the condition of the exchanger vanes.
- Check the bypass damper functionality.
- Check the drop eliminator condition.
- Check the connection of the condensate drainage.

### Gas Heater Section

- Check the connection of the condensate drainage.
- Check the wiring and functionality of the sensors and thermostats.
- Check the gas burner connection.
- Check the air-venting of the gas distribution system.
- Check the gas-flue connection.
- Check the bypass damper functionality

### Rotary Heat Exchanger Section

- Check the rotor and exchanger's frame alignment (the frame's rectangularity must be ensured).
- Check the rotor for free rotation.
- Belt tension
- Close fitting of sealing brushes
- Check the motor for correct wiring.
- Motor running direction  
Input current of the motor (refer to the type plate)

### Fan Section

- Check the fan impeller for intactness and free rotation.
- Check the tightening of the Taper-Lock collets.
- Check the tightening of the screw joints of the fan assembly.
- Check the protective covers for integrity and mounting
- Check the fan impeller, inlet and outlet for cleanliness and foreign objects

#### *Extra for fans with a belt drive:*

- Check the belt tension.
- Check pulley alignment  
Check V belts for integrity

Until the air-handling system is adjusted, the air-handling unit can only be put into operation when the regulating damper in the air-handling unit inlet is closed. Operating the air-handling unit while the air-handling system is misadjusted can cause motor overloading and permanent damage. If the second stage of filtering is included in the air-handling unit, it is advisable to run the testing operation with the second stage filter inserts removed.

## Operating Checks and Service Regulations

### Checking During the First Start-Up

- Check the proper direction of the impeller rotation following the direction of the arrow on the impeller or fan casing.
- Check the proper direction of the rotary heat exchanger rotation following the direction of the arrow on the rotor situated under the service panel.
- Check the input current of connected equipment (it must not exceed the maximum permissible value stated on the rating plate).
- Check the proper direction of the rotary heat exchanger rotation following the direction of the arrow on the rotor (from the service panel side always upwards) and free rotation without dragging.
- After 5 minutes of operation, stop the air-handling unit and check the temperature of bearings and the tension of belts (belt-driven fans only). This check may only be performed if the fan is switched off!
- Check the water level in the condensate draining kit. If the water has been sucked off, it will be necessary to increase the height of the siphon.
- Check the mounting of the filters

During the testing operation, it is necessary to check the air-handling unit for unusual noises and excessive vibrations. The testing operation must last at least 30 minutes. After the test operation has finished, the air-handling unit must be inspected. Pay special attention to filters and check them for damage, the fan section and check the belt tension, the tightening torques of threaded pins of Taper-Lock collets (refer to the Table of Taper-Lock collet tightening torques), and proper functioning of the condensate draining kit.

If the unit vibrates too much, it is necessary to check again the fan assembly and perform vibration intensity measuring, if necessary. If vibration intensity of the fan assembly with an overhung impeller (XPAP section, XPVP assembly) exceeds 2.8 mm/s, measured at the motor bearing shield on the impeller side, the fan must be checked and balanced by professional staff. During the testing operation it is necessary to adjust (regulate) the entire air-handling system. Before putting the air-handling unit into permanent operation, it is recommended to replace or regenerate the filter inserts.

### Service Regulations

Before putting the air-handling device into permanent operation, the supplier (installing company) in collaboration with the designer must issue service regulations in accordance with local legal regulations. We recommend including the following in these service regulations:

- Air-handling device assembly description, its intended use and a description of its activities in all operating modes.
- Description of all safety and protective elements and their functioning.
- Health protection principles, safety and operating rules to be observed when operating the air-handling device.
- Requirements for operating staff qualifications and training, a nomenclature list of personnel authorized to operate the air-handling device.
- Detailed emergency and accident instructions to be followed by the operating staff.
- Operating particularities during different climatic conditions (e.g. summer or winter operation).
- Inspection, checking and maintenance schedule, including a list of checking steps, and their recording
- Records of operating staff training, operation, inspections and cleaning of the rotary heat exchanger (subject to guarantee validity).

### Unit Operation Screening Checks

Průběžné provozní kontroly klimatizační jednotky se provádí vizuální a poslechovou kontrolou jedenkrát týdně (denně) bez narušení chodu jednotky.

The operating staff checking activities must be focused on the following:

- Check the operation and functionality of the air-handling unit.
- By listening, check proper operation of the fans (strange noises and excessive vibrations of the unit) and, if needed, balance the fan, refer to the section Unit First Start Inspection.
- Check the casing, doors and service panels for leakage.
- Check the temperature of the media and transported air
- Check the condition and operation of the control and sensing systems associated with the air-handling unit, whose proper functioning is necessary for proper operation of the air-handling unit as well as for operation of the entire air-handling system. These are:
  - Electric wiring
  - Measuring & control system (M&C)
  - Heating system - circuit leak-tightness, pump operation
  - Water filter fouling (also in SUMX)
  - Cooling system - circuit leak-tightness and function
  - Condition of piping insulation
  - Sanitary installation - condensate drainage
  - Gas heater system

### Regular Inspections

The user will determine the intervals for regular inspections of the air-handling unit according to the operating conditions, however, at least:

#### a) Once every three months

Check for contamination and possible damage to the basic functional groups of the air-handling unit:

- Filters (hygiene condition, fouling, unacceptable damage or perforation)
- Heat recovery, heat-exchangers (functionality, fouling, leakage or damage)
- Humidification system (hygiene condition, functionality, circuit tightness, fouling of jet nozzles)
- Condensate drainage (for stagnant water in the tray or elsewhere in the equipment)

#### b) Once every six months

- Check all the functional groups of the air-handling unit for functionality, failure-free state, corrosion, cleanness and hygiene, including necessary maintenance, cleaning and repair and/or replacement of damaged parts.
- This inspection is usually carried out in the spring and autumn months, i.e., before the winter and summer season during a short downtime of the equipment

#### c) Once a year

- General service inspection of the air-handling unit for functionality, failure-free state, corrosion, cleanness and hygiene, including casing and covering roofs, and necessary maintenance, cleaning and repair and/or replacement of damaged parts.
- It is carried out mainly in the summer months during a longer downtime of the air-handling unit.

## Operating Checks and Service Regulations

### ■ Basic items of the service inspection:

- Cleaning of the external casing, covering parts and roofs of the air-handling unit (see the chapter Cleaning)
- Cleaning of inlet and outlet chambers
- Replacement of filter inserts and cleaning of the chamber
- Inspection and cleaning of fans (condition and tension of belts, greasing of bearings)
- Inspection and cleaning of the plate or rotary heat exchanger of the heat recovery system
- Inspection and cleaning of heat exchangers, check of the circuit for leakage
- Inspection of the cooling system, including filling with refrigerant, if needed, performed by a cooling technician
- Inspection and cleaning of the humidification system (disinfection, cleaning of jet nozzles, inspection of steam generator's containers)
- Inspection and cleaning of the condensate trays and condensate drainage system
- Inspection of the electric heater
- Inspection of the gas heater section (adjustment of the burner performed by an expert technician)
- Check of saturation (weight) of the carbon filter cartridges
- Inspection and cleaning of closing dampers (include adjustment)
- Inspection of elastic connections for tightness
- Cleaning of air ducts and all the end elements, inspection of insulation
- Cleaning of other areas of the air-handling devices (service and air mixing sections, etc.)
- Inspection of fire dampers (by an authorised technician)
- Repairs of corroded parts
- General cleaning of the air-handling plant

### ■ The cleaning procedure is described in the following chapter:

### Cleaning

- Inspection of the air-handling unit for cleanness and removal of coarse dirt must be performed at least twice a year. It is advisable to perform general cleaning associated with the air-handling unit downtime as part of the service inspection at least once a year.
- When cleaning the air-handling unit, remove all dirt from external and internal parts of the unit, including the covering roof (if installed).
- **Recommended methods of cleaning:**
  - Recommended cleaning solution - 10 parts dishwashing liquid, 45 parts Isopropanol, 45 parts water - pH 5-9. Do not use cleaners containing active chlorine.
  - Steam cleaning equipment (max. 50°C).
  - When high-pressure cleaning equipment is used, there is a risk of paint damage, especially in the elbows.
  - Do not use brushes or similar abrasive tools and abrasive cleaning agents!

To avoid differences in colour in some areas, first use the cleaning agent on a small area to verify it does not damage the anti-corrosion protection coating of the casing before using it on the entire area.

Uncleaned dirt deposited in the unit can be a source of bacterial contamination and cause corrosion. In case of corrosion, the corroded surface must immediately be treated with suitable anti-corrosion protection.

Basic methods of cleaning each specific built-in assembly are described below in these operating instructions, please see the chapter for the corresponding built-in assembly.

### Fan Inspection

- Check the impeller for cleanliness.
- Check the impeller for integrity and free rotation
- Check the assembly screw connections for tightening

### Additional checks of fans with a belt drive

- Check the tightening of the Taper-Lock threaded pins
- Check the silent-blocks for condition (damage)
- Check the outlet fan assembly elastic sleeves
- Check the motor and fan bearings in the fan case.
- Check fan belts for wear (if necessary, all fan belts must be replaced).

### Checking the V-belts for tension

- The V-belts must be retightened after the first hour of operation. Subsequent checks of belts for tension must be performed every three months.
- To check the belt tension, it is advisable to use suitable equipment (a belt tension tester). The following chart (graph 1) shows the relation between the slack (S) and the distance of the belt pulleys (A). The force "F" needed to slack the belt is determined according to the belt type and the diameter of the smaller pulley.
- Turn the tensioning screw to set the proper belt tension (see figure # 23)
- Excessive belt tension can cause overheating of the bearings and damage or overloading of the fan motor.
- Too low belt tension can cause slipping and premature wear of the belt.
- When changing the belt on a multi-grooved pulley, all the belts on this pulley must be ganged!

Figure 22 – Belt tension adjustment

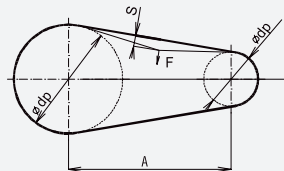
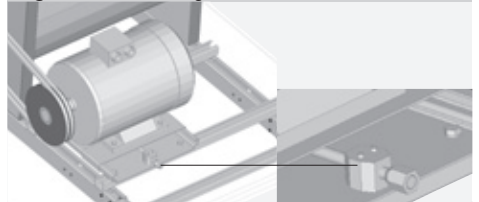

Figure 23 – Tensioning screw



## Operating Checks and Service Regulations

**Table 5 – Belt tensioning forces**

Belt profile	Small pulley diameter mm	Recommended force to deflect the belt [N]*	
		min.	max.
SPA	80–140	20	27
	140–200	27	35
SPB	112–224	35	50
	236–315	50	65

\*The force needed to deflect the belt to achieve 16 mm belt slack at a distance between pulley axes of A = 1000 mm.

**Chart 1 – Belt slack „S“ and pulley axes distance „A“ relation**

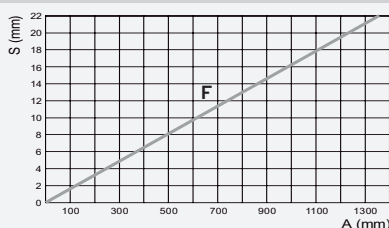

### Check pulley alignment

After replacing and tensioning the belts or pulleys, it is necessary to check the alignment of the pulleys (use a metal ruler or other suitable alignment measuring equipment, see figure 24). Specifications of limit values are included in table 7.

**Figure 24 – Pulley alignment**

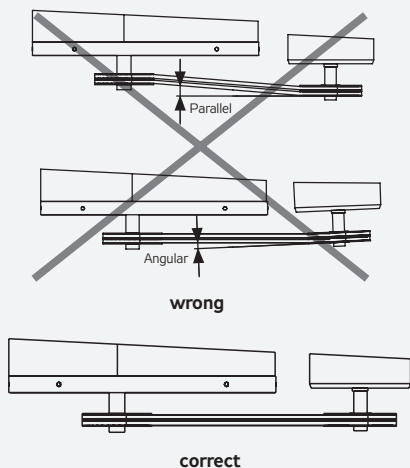

**Table 7 – Pulley alignment tolerances**

Misalignment type	Max. Misalignment range
Angular	0,25°
Parallel	1 % (0,25°)

The following applies:

#### Parallel:

Maximum misalignment of parallel planes: 0.01 x axis distance (i.e., max. 10 mm at axis distance of 1 m)

#### Angular:

Misalignment of the pulley from the plane: 0.25° for each meter of distance (i.e., max. 0.5° at axis distance of 2 m)

The pulleys are equipped with Taper-Lock collets which enable their alignment (see figure # 25). The torque values for the set screws on the clamping hubs are included in table 6.

**Figure 25 – Taper Lock® collet**

#### Assembly



Before collet and pulley assembly, carefully clean the inner collet opening and taper surface.



Insert the collet into the pulley hub so that the threaded openings will check with the openings without thread.



Tighten the fixing screws by hand.



Carefully clean the shaft, and place the pulley in the required position. Tighten the fixing screws alternately with the prescribed tightening torque.



#### Disassembly

Loosen the fixing screws, and insert one or two of them as force-off screws (according to the collet size) into the withdrawal openings. Knock slightly on the pulley. Keep tightening the force-off screws until the collet is released from the pulley.



**Table 6 – Taper-Lock collet tightening torques**

1008	1108	1210	1610	1615	2012	2517	3020	3030	Taper-Lock	3525	3535	4030	4040	4535	4545	5040	5050
5,6	5,6	20	20	20	30	50	90	90	Tightening torque (Nm)	115	115	170	170	190	190	270	270

## Operating Checks and Service Regulations

### Maintenance and lubricating of ADH-RDH double-inlet fans equipped with a spiral fan casing and belt drive

All maintenance operations and lubrication must be performed using suitable tools and implements. First check the bearings by listening to them. If the bearings are in good condition they will generate a slight and constant noise while defective bearings will generate a loud and irregular noise.

Low metallic noise, which is caused by the standard allowances between components, especially at low speed, is normal. Excessive vibrations and increased temperature of bearings indicate a possible defect.

It is also necessary to check the mounting of the fan bearings in their casings for intactness and also for excessive lubricant leakage. Moderate leakage of lubricant, especially during the fan commissioning, is normal and has no negative influence on the fan operation.

Estimated mechanical service life of bearings installed in the ADH/RDH Nicotra fans is 40000 hours providing the fans were selected considering their operating limits, the environment and planned drive size.

The service life of the bearing lubricant can be shorter than the service life of the bearings.

Bearings mounted in rubber silentblocks or in casings without lubricating nipples are not intended to be additionally lubricated. Bearings equipped with lubricating nipples are used with fans intended for heavier duty operation and working conditions. Regular lubricating is essential to achieve the maximum service life of bearings.

Only bearings of ADH/RDH „K“ and „K1“ fans (intended for higher performance) need to be lubricated.

Marking of fan assemblies: XPVA and XPVR with „K“ and „J“ in the tenth place of their code

### Lubricating Bearings

There are many factors influencing the lubricating interval of fan bearings: bearing type and size, working speed, ambient temperature, diameters of pulleys, installed input, type of lubricant and working environment. Therefore, information based only on statistics can be provided.

*Resulting from the above-mentioned reasons, the lubricating interval of bearings  $t_f$  (i.e. the period for which the bearings are lubricated at 99% certainty, and which represents the time  $L1$  - service life of the lubricant, e.g.  $L10$  - the service life of the lubricant equals  $2.7 \times L1$ ) can be obtained from the chart below considering the speed and pulley diameter. This chart is valid for bearings mounted on horizontal shafts and for normal loading at temperatures up to 70°C.*

**Never schedule the lubricating interval longer than 30000 hours.**

The amount of lubricant for standard applications (the temperature will not exceed 70°C) can be calculated from the relation below:

Calculation of the grease amount:

$$(g/h) = 0.005 \times D \times B$$

g = grease amount (g)

h = service hours

D = outside diameter of the bearing (mm)

B = total width of the bearing (mm)

To re-lubricate the bearing, it is necessary to use the same type of lubricant as that used for the original lubrication

**Figure 26 – Bearing lubricating intervals**

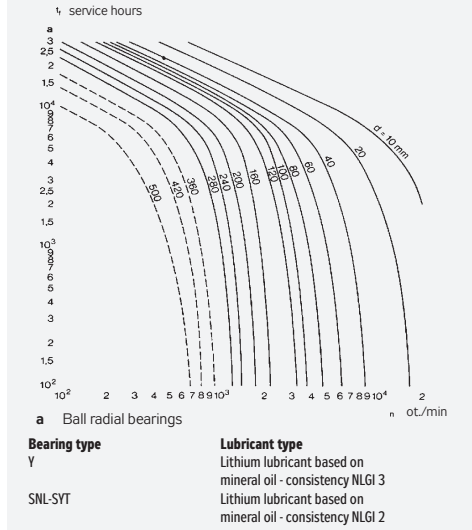

### Checking the Dampers

- Check the dampers for cleanliness.
- Check the damper blades for rotation.
- Check proper damper closing

### Checking the Filters

- Check the filters for condition and fouling (fouled filter inserts must be replaced).
- The filter inserts must be exposed in an environmentally-friendly way.
- Check the settings of the differential pressure sensors.

### Maximum values of the pressure drop for each filter type (according to EN13053:2006 E):

- G3-G4 150 Pa
- M5 (F5), M6 (F6), F7 200 Pa
- F8-F9 300 Pa

### Filter Replacement

Different types of filter mounting are used depending on the air-handling unit size, filter type and filtration class. When replacing filter inserts, always check the condition of the sealing; if damaged, replace the sealing with a new one. If checking or replacing the filters, follow these procedures:

**Figure 27 – Filter insert removal**

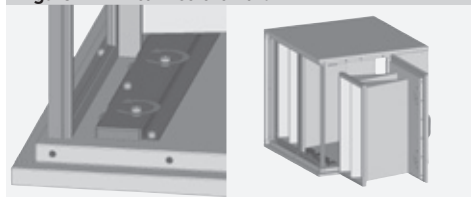

# Air Handling units AeroMaster XP

## Operating Checks and Service Regulations

**Table 7 – Bag, compact and paper board filters – dimensions (mm) and number**

	G3, G4 filters							M5, F7, F8, F9 filters					Replacement bag filter kit	M6-F9 filters			Replacement compact filter kit	
	53x495	340x645	420x805	287x897	592x592	592x897	897x592	53x495	340x645	420x805	287x287	287x592		592x287	592x592	592x287		592x490
XP 04	1							1										XPNJ04/xx *
XP 06		2						2									1	XPNJ06/xx *
XP 10			2						2									XPNJ10/xx *
XP 13				1						1	1	1	1					XPNJ13/xx *
XP 17						1							2	2				XPNJ17/xx *
XP 22					4									4				XPNJ22/xx *
XP 28					2		2					2		4				XPNJ28/xx *
length **	350	350	350	305	305	305	305	600 (360)	600 (360)	600 (360)	550 (360)	550 (360)	550 (360)	550 (360)				

\* The required filtration class must be specified after the mark xx (04, 05, 07, 08, 09 – standard length of bags/ K5, K6 – shortened length of bags)

\*\* the value in the brackets parentheses applies for M5 filters (marked K5) and M6 (marked K6)

	G4 filters					Replacement paper board filter kit
	544x492	347x642	427x399	592x592	592x450	
XP 04	1					XPNM 04/4
XP 06		2				XPNM 06/4
XP 10			4			XPNM 10/4
XP 13					2	XPNM 13/4
XP 17				4		XPNM 17/4
XP 22				4		XPNM 22/4
XP 28				2	4	XPNM 28/4
length	96	96	96	96	96	

### XP 04, XP 06 and XP 10 Air-Handling Units

To remove the filter insert, turn the screws (XP 04 - 2 screws; XP 06 and XP 10 - 4 screws) counter-clockwise using Allen wrench # 6, release the fixing clips and pull the filter insert out of the groove (see figure # 28). Reinstall the filter inserts in the reverse way.

**Figure 28 – Filter insert releasing**

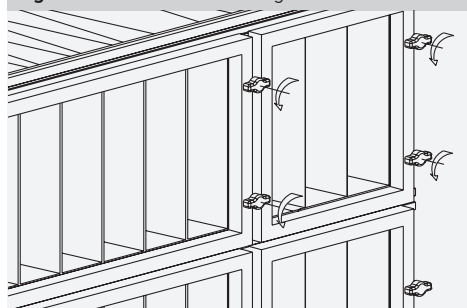

The 96 mm long wall of frame filters can be removed by pulling the frame edge out and then realising the sheet steel retaining clips. The replacement filter can be installed in the reverse procedure: Carefully bend (without permanent distortion) both edges of the vertical paper frame, install the clips and place all the filters between the bars, first the lower row then the upper row, until they are completely seated. It is advisable to perform regular inspections of the frame filters, especially if high air humidity is present or if it fluctuates through the day. Unsuitably low pressure loss read on the manometer can indicate frame distortion. If this happens, a physical check of the filters is recommended.

### XP 13, XP 17, XP22 and XP 28 Air-Handling Units – G3 to F9 Filtration Class

Filter inserts are inserted in separate fields of the filtering wall which can be pulled out from the air-handling unit. To replace the filter insert, turn the securing locks by 90°, and replace the filter insert with a new one. Before inserting new filter inserts, check the sealing. Check the filter insert centring, and push the filtering wall back into the air-handling unit.

#### Active Carbon Filter Cartridge Check

- There is no pressure loss in the active carbon filter cartridge due to fouling.
- The most effective way to check the saturation of filter cartridges is by weighing them. After reaching their maximum capacity, i.e. their net weight has increased by about 20% to 50 % (depending on the type of carbon and filtered gas; ask the manufacturer for precise information), the carbon cartridge must be reactivated. If this limit is exceeded, the filtering efficiency will be diminished. The total weight of the clean standard, 450 mm long, active carbon filter cartridge is 2500 g, the weight of the filling is 2000 g (max. recommended increase in weight is 400 to 1000 g).
- As the complete cartridge must be reactivated, it is advisable to possess a spare set of filter cartridges.
- Subsequent intervals of cartridge replacement can be scheduled on the basis of the above-mentioned weight measurement.

#### Checking the Exchangers (Heaters, Coolers)

- Be very careful when cleaning the exchanger's vanes to avoid mechanical damage.
- It is important to check the air-venting of the exchangers.
- Permanently check the functionality of the condensate draining system (coolers).

**Important note:** If taking the exchanger out of operation during the winter season, the water must be completely drained out of the exchanger, and possible water residuals must be removed, e.g. by flushing the exchanger with pressurised air; or the exchanger must be filled with a safe antifreeze solution of water and glycol. The water residuals can freeze in the exchanger and damage the copper pipes.

## Insert air filter textile replacement

Figure 29 – Release of clamping bars

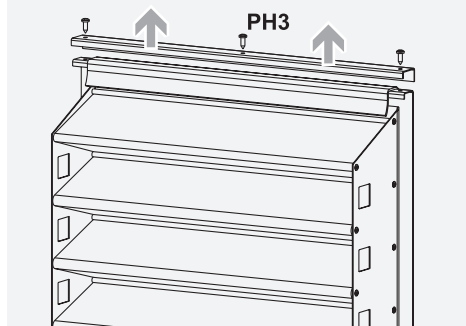

Figure 30 – Old textile removal

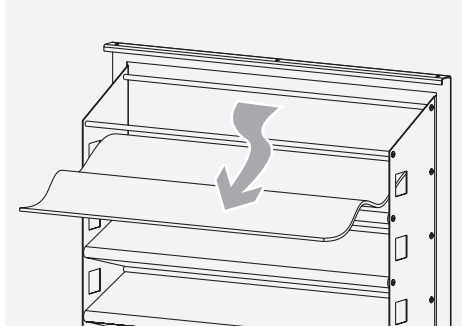

Figure 31 – New textile insertion

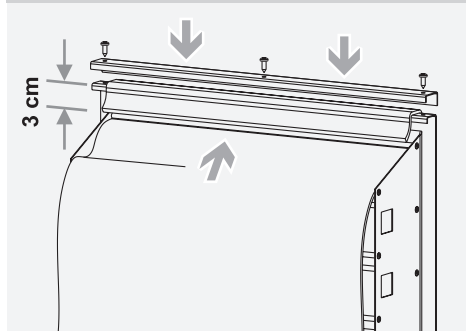

Figure 32 – Interlacing and stretching

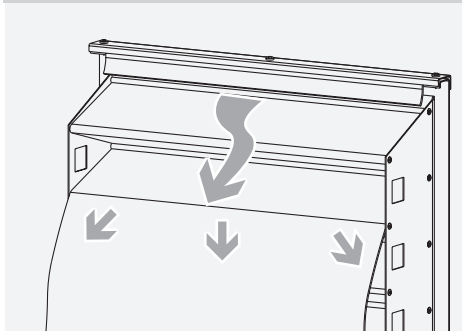

Figure 33 – Installation finishing

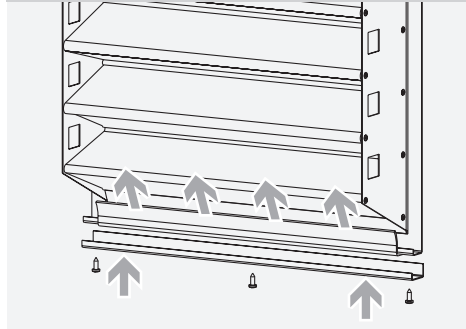
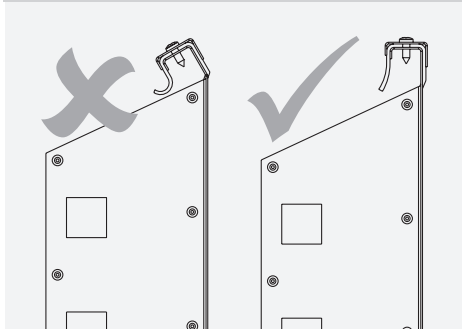

Figure 34 – Proper installation check





## Operating Checks and Service Regulations

### Steam Generator Check

All prescribed checks are included in the Installation Instructions attached to the steam generator. Please follow these instructions, especially the following:

- First 5 hours of operation: check the water conductivity (min. 5 refills per water exchange cycle, sparking and max. current checking); check the cylinders for condition (water leakage) and operation; check the tightening of electrical connections.
- Every three months: check the steam generator operation (number of water refilling switching per cycle) and the condition of the cylinders (water leakage, condition of electrodes and inner casing of the cylinder).
- Yearly or every 2500 service hours: replace the boiling cylinders; check the condition and shape of hoses; check the sealing of the distributing tubes inside the chamber; check the tightening of electrical connections.

**Warning:** Attention-electrical equipment! The steam generator cylinder can be hot. In case of water leakage, hazard of burning and/ or electric shock exists! The intervals of inspections and service life of parts can vary depending on the water quality and operating conditions.

### Checking the Electric Heater

- Check the heating coils for fouling; vacuum the heating coils if necessary.
- Check the functionality of the safety thermostats.

### Checking the Plate Heat Exchangers

- Check the heat-exchanging surfaces of the plate heat exchanger for fouling.
- Check the by-pass and mixing dampers for fouling and functionality (if included in the system).
- Check the condensate drainage for functionality
- If fouling of the heat exchanger is found, clean it. Using the correct filtration class of filter inserts inside the air-handling unit has a major impact on the plate heat exchanger fouling. If excessive fouling of the plate heat exchanger is found, the condition of the filters must be checked, or filter inserts of a higher filtration class must be installed.

**The entire block of the plate heat exchanger can be cleaned using the following procedure:**

- Remove dust and lint using a soft brush or vacuum cleaner.
- Grease or oil traces can be removed using warm water or suitable grease solvents. Use only harmless cleaning agents.
- If compressed air is used to clean the plate heat exchanger, be careful to avoid damaging the heat exchanger's fins. They are made of thin aluminium sheets! Keep the air gun at a safe distance.
- High-pressure cleaning equipment can be used if the following conditions are met:
  - A special 40° nozzle for sensitive surfaces must be used.
  - Maximum allowed water pressure is 100 bars.
- When cleaning, avoid any mechanical or chemical damage to the plate heat exchanger.

### Checking the Rotary Heat Exchangers

Rotary heat exchanger condition inspections must be performed regularly; checking the rotor for cleanliness is the most important part of these inspections. The user will determine the intervals for regular inspections according to the operating conditions, however, at least once every 3 months. At the same time, the user must perform the following checks:

- Check the functionality.
- Check the rotor for cleanliness.
- Check the sealing brushes for tightness.
- Check the rotor condition and tension of the driving belt.
- Check fouling of filters; inlet and outlet.

If fouled or damaged, the filters must be replaced with new ones immediately. If any fouling of the rotor is found, the user must ensure its expert cleaning. The rotary heat exchanger rotor can be cleaned by pressurized air, steam or pressurized water. Failure to perform maintenance can result in permanent damage to the rotary heat exchanger rotor and very expensive repairs.

### Gas Heater Section Check

The gas heater inspection must be carried out once a year, including the burner adjustment and flue gas measurement!

### Verification Measurements

After completing the regular inspection of the air-handling unit, it is necessary to verify and record its actual performance parameters.

### Water Connected Air-handling Component Installation

Recommendations on water quality for heat exchangers that operate using low pressure hot water (LPHW) and chilled water:

- A good water quality - e.g. salt and lime-free drinking water - increases the lifetime and efficiency of the heat exchanger.
- Check the limiting values shown in the table annually to prevent damage to the hydraulic system and its components.
- If necessary inhibitors must be added.

*Note: These limiting values are only basic information about the water quality and do not form any basis for a guarantee!*

Description	Symbol	Values	Effects in vent of deviation
Hydrogen ion concentration	pH	7,5 - 9	< 7 > 9 Corrosion Fouling
Calcium and magnesium content	Hardness (Ca/ Mg)	4 - 8,5 °D	> 8,5 Fouling
Chloride ions	Cl <sup>-</sup>	< 50 ppm	Corrosion
Carbon dioxide	Fe <sup>3+</sup>	< 0,5 ppm	Corrosion
Iron ions	Mg <sup>2+</sup>	< 0,05 ppm	Corrosion
Carbon dioxide	CO <sub>2</sub>	< 10 ppm	Corrosion
Hydrogen sulphate	H <sub>2</sub> S	< 50 ppb	Corrosion
Oxygen	O <sub>2</sub>	< 0,1 ppm	Corrosion
Chlorine	Cl <sub>2</sub>	< 0,5 ppm	Corrosion
Ammonia	NH <sub>3</sub>	< 0,5 ppm	Corrosion
Ratio of carbons/ sulphates	HCO <sub>3</sub> <sup>2-</sup> / SO <sub>4</sub> <sup>2-</sup>	> 1	< 1 Corrosion

1/1,78 °D = 1 °Fr, with 1°Fr = 10 g CaCO<sub>3</sub>/m<sup>3</sup>

ppm = parts per million (mg/l)

ppb = parts per billion ( g/l)

## Spare Parts and Service

### Spare Parts and Service

Spare parts are not included in the air-handling unit delivery. If any spare parts are needed, they can be ordered from REMAK a.s. or the regional distributor. In your order, specify the unit serial or purchase order number, and the parts needed.

### Spare Filter Inserts

A complete set of filter inserts can be ordered. Specification of the filter type (bag, compact, insert, or grease/metal filter), XP air-handling unit size and filtration class will do. There is no need to specify the types of individual filter inserts of the filter.

### Active Carbon Cartridges

The active carbon cartridges are designed for a specific composition of filtered gases. The carbon cartridge is reactivated as a whole. Active carbon which contains toxic substances, radioactive impurities or PCB cannot be reactivated!

### Service

Guarantee and regular servicing can be ordered from REMAK a.s. or the regional distributor.

The manufacturer can authorize trained service providers to perform this service; their list can be found at [www.remak.eu](http://www.remak.eu).

### Disposal and Recycling



#### Information for disposal in other countries outside EU

Observe the applicable local environmental protection and waste disposal regulations.

#### For users from EU countries

When disposing of components and materials, observe the 2012/19/EU Directive, applicable national and local environmental protection and waste disposal regulations.

#### For users from the Czech Republic

Observe the applicable local environmental protection and waste disposal regulations. Active carbon which contains toxic substances, radioactive impurities or PCB must be disposed of in accordance with applicable legal regulations.

When disposing of the air-handling unit once its service life has expired, follow Waste Act No.185/2001 Sb.

#### Waste Classification

(in accordance with Directive No. 381/2001 Sb.)

- 15 01 01 cardboard box  
(paper and cardboard packaging)
- 15 01 02 polyester packaging pads  
(plastic packaging).
- 15 01 03 pallet  
(wooden packaging)

#### Disabled device and its parts:

- 13 02 06 Waste engine, transmission and lubricating oils  
(synthetic engine, transmission and lubricating oils)
- 16 02 06 metal and aluminium parts  
insulating material  
(other items from disabled devices)
- 15 02 03 filtering materials
- 16 02 15 electrical parts  
(dangerous items from disabled devices)

## XPRJ and XPRF Sections

### XPRJ (for control system built-in assembly)

### XPRF (for frequency converter/s)

**Figure 1 - control system assembly section**

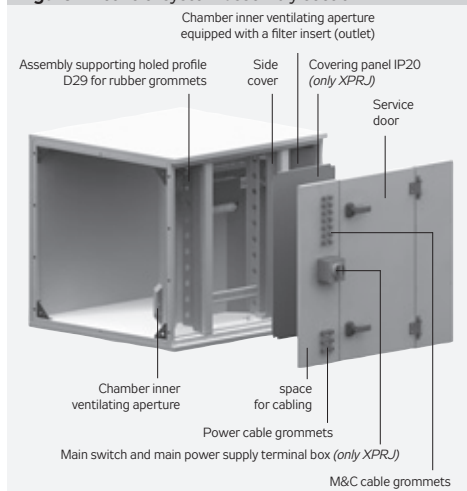

### Basic Data (ČSN EN 60439-1)

- **Classification:** One-chamber covered case equipped with solid parts intended for a particular use.
- **Installation:** The case can be built into the AeroMaster XP air-handling unit.
- **Standards:** IEC 60439-1, ČSN EN 62208 (IEC 62208:2002)
- **Covering:**
  - A metal (galvanized) case built into the XP section, accessible through the service door and covering panel which can be removed only using tools (XPRJ).
  - A metal (galvanized) case built into the XP section, accessible through the service door (XPRF).
- **Degree of protection - door closed:** IP 44
- **Degree of protection - door open:** IP 20 (XPRJ) / IP20 (XPRF)\*
- \* *The case itself IP00, frequency converters IP20.*
- **Operating conditions:** Indoor installations 0 °C to +35 °C, outdoor installations -40 °C to 50 °C (with accessories).
- **Storage:**
  - 30 °C to +70 °C (XPRJ),
  - 25 °C to +65 °C (XPRF)
- Max. relative humidity 85%,  
Without condensation and frost deposit.
- **Grounding system:** PE conductor
- **Dimensions:** see the section description.
- **Weight:** see the section description.
- **Types of electrical connections of functional units:** FFF
- **EMC - incl. integrated assemblies:** environment 1

### General Warnings

When handling, installing, wiring, commissioning, repairing or servicing this device, it is necessary to observe valid safety rules, standards and generally recognized technical rules. Every device connection must comply with the respective safety standards. The device must be used only as intended and in accordance with this documentation and the documentation of related assemblies - control units and frequency converters. No changes influencing the device safety can be made without the permission of the manufacturer/supplier. Keep this document for further use!

### XPRJ Section Intended Use

The XPRJ section is designed for control unit assembly which supplies and controls the AeroMaster XP air-handling unit. The section is provided with a main switch.

### XPRF (Frequency Converter) Section Intended Use

The XPRF section is designed for the AeroMaster air-handling unit frequency converter assembly.

### Wastes and Waste Classification

In case of final unit liquidation of the product or any part, it is necessary to observe the respective national environmental protection and waste disposal regulations. Follow the rules of sorted waste disposal, respect differences in material and their composition (metals, plastics, electrical parts, mineral wool, etc).

It is advisable to hire a provider specialized in the waste disposal of these materials.

## XPRJ and XPRF Sections

### Personnel Protection Measures

#### Protection Against Dangerous

##### Contact of Non-Live Parts

The protection against dangerous contact of non-live parts is performed by design measures ensuring electrical conductivity: spot-welds, screw joints with fan washers, interconnection with protective conductor (PE) in accordance with ČSN EN 60439-1.

#### Protection Against Dangerous Contact of Live Parts

The protection of XPRJ section against dangerous contact of live parts is ensured by the removable cover (guard) which is accessible after opening the service door and removable only if a tool is used; degree of protection IP20 (ČSN EN 60439-1).

The protection of the XPRF section against dangerous contact of live parts is ensured by the degree of protection of built in devices, min. IP20. Protection of the XPRJ and XPRF sections against dangerous contact of live parts is ensured by a removable cover (guard) which is accessible after opening the service door and removable only using tools; degree of protection IP20 (ČSN EN 60439-1). Protection of the frequency inverters situated on the unit casing against dangerous contact of live parts is ensured by the degree of protection of the built-in devices, min. IP20(21) and a cover which increases the degree of protection to IP4X in accordance with ČSN EN 60204-1. The cover is delivered separately along with the frequency inverters and must be installed (installation holes ready for the factory).

**Figure 2 –** Frequency inverter cover (IP4X)

Sheet steel cover



Plastic cover



## Integrated Cooling Section

Separate documentation is delivered with this section. This documentation is available to download form at our website: [www.remak.eu](http://www.remak.eu)

**Figure 1 –** Integrated Cooler Section



## XPRJ and XPRF Sections

### Section Description

The case for built-in electrical elements is integrated into the 1000 mm long modular XP through section. The section casing is designed as a standard XP unit section (sandwich panels with inner 50 mm insulation) and equipped with a hinged service door.

All case parts are made of 1 mm thick bent steel sheets galvanized with a 275 g/m<sup>2</sup> zinc layer. The internal fixing elements are made of 2.0 mm steel sheets. The case parts are spot welded and sealed with silicone sealant.

To increase air auto-convection, the case is provided with inlet (lower) and outlet (upper) ventilating apertures for inlet and outlet of air coming through the XP unit. The ventilating apertures are protected against water by a labyrinth cover (IP44) and against dust by a replaceable filter insert (EU3).

The outdoor version is completed with protective elements against weather effects (optional accessories of the AeroMaster XP air-handling unit).

Electrical wiring, interconnection of individual parts, initial inspection, operation and maintenance must be performed in accordance with applicable standards and regulations.

Creating and maintaining conditions - the temperature - for proper operation of individual components, is an essential factor for outdoor installations of the XP section equipped with the control unit.

Therefore, it is necessary to use additional accessories for heating or cooling. These accessories are delivered in accordance with the operating conditions specified in the project (using AeroCAD software) for which the designer is responsible.

### Instructions for Cabling

- A set of frequency converters up to  $2 \times 18.5 \text{ kW} + 1 \times 0.37 \text{ kW}$  output can be installed in the XPRF section (depending on the XP unit size).
- All interconnections of the distribution board and installed elements must be made using intact double insulated cables which must be properly dimensioned for the given load and lead length.
- Every cable leading out from the section must be led through the preinstalled cable grommets. All unused grommets must be blinded to maintain the degree of protection.
- When connecting and leading the cables, it is necessary to take into account their properties. The conductors must not be exposed to strains which decrease their service life. Avoid cable slack; always use cable protectors and trenches (wire, plastic, or metal) of sufficient size and length. Properly fix all cables and keep to minimum bending radii.
- The M&C cable lines must be led separately from the power cables to avoid their interference. We recommend leading the power cable lines along the base frame and the M&C cable lines along the front edge of the top panel.
- The cable lines must never interfere with the service panels (doors), removable panels (e.g. panel with handles, exchanger outlet panel, etc.) or obstruct routine operation and servicing. Please respect the reserved servicing space.

**Table 1** – Basic dimensions of XPRJ / XPRF sections

Size	L (mm)	W (mm)	H (mm)	E	m (kg)*
XP 04	1000 mm	650	600	230	84
XP 06		800	750	230	103
XP 10		960	910	330	125
XP 13		1065	1015	330	138
XP 17		1370	1015	330	154
XP 22		1370	1320	330	177
XP 28		1675	1320	330	193

\* Weight of empty section

### Installation Instructions, Operation and Maintenance

XPRJ and XPRF Sections are designed to be installed in the AeroMaster XP air-handling unit assembly. For packaging, transport, handling and installation, refer to „Goods Despatch“ and „Installation“.

Staff qualification requirements: installation, connection, commissioning, repairs and maintenance can only be performed by properly qualified personnel.

**Figure 1** - Basic dimensions of the section

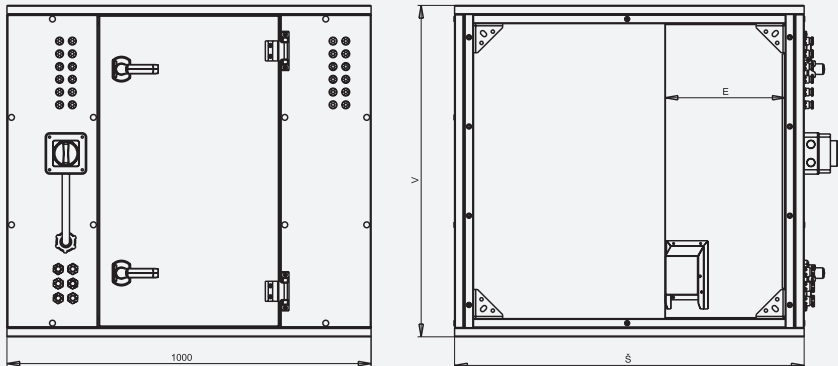

## XPRJ and XPRF Sections

**Figure 2 - Section cable departures**

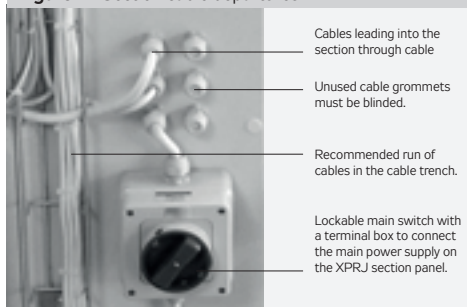

**Figure 3 – Cabling inside of the box**



### Wiring Procedure:

The wiring diagram (incl. cabling) and Installation, Commissioning and Operating Instructions are included in the accompanying documentation of the control unit; it is also necessary to use the AeroMaster XP Installation, Commissioning and Operating Instructions.

#### General Procedures for Wiring:

- Connect power elements.
- Connect M&C elements.
- Check the installation of the air-conditioning unit (if delivered).
- Connect the air-conditioning unit heater section (see Accessories).
- Lead the main power supply (cable harness dimensioned for the total input current of the air-handling unit) to the main switch terminal box on the section panel.
- Check the completed wiring.
- Check the tightening of the cable grommets, and blind those unused.
- Perform the electrical equipment initial inspection.

#### Note:

To mount the cables and wiring harness inside the section, use the rubber grommets installed in the openings of the assembly supporting profile to avoid damage to the cable insulation, see figure # 29.

### Safety

- When performing any work, repairs or maintenance, the device must always be disconnected from the power supply.
- When planning or installing the air-handling unit, observe normative requirements for safe access to the air-handling unit.
- When reinstalling the covers (front or side covers) also restore their conductive connections (properly tighten the screws using fan washers).
- Maintain the prescribed degree of protection.

### Maintenance

- XPRJ/XPRF sections do not require any special maintenance if installed in the intended environment.
- Any damage to the surface protecting galvanized layer (zinc 275 g/m<sup>2</sup>) must be repaired immediately with priming paint (S2013) to avoid corrosion.
- Depending on the operating conditions, regularly check the filter inserts of the chamber inner ventilating apertures

### Accessories

- Heating elements to keep the minimum prescribed temperature inside the chamber; a set according to the XP air-handling unit size to be installed on the DIN bar inside the section
  - Set of heating elements for temp. range from -25 °C
  - Set of heating elements for temp. range from -40 °C
- The 620 W chamber air-conditioning unit is to be mounted on the service door of the section; designed for indoor and outdoor installations (-20 °C / +55 °C).
- Set of filter inserts for chamber ventilating apertures.
- Filtering textile cuts, 125 x 125 mm.

The set of heating elements (AC 230V/50Hz, 400W) consists of one or more compact resistance elements with a heat radiator made of electrolytically oxidized aluminium profile and a fan (45 m<sup>3</sup>/h). Safety switch of the heating element - to protect it against overheating if the fan fails.

- Connection using the thermo-contact
- Degree of protection: IP20
- Protection Class: grounding
- Max. surface temperature: 75 °C

**Figure 4 - Air-conditioning box**



# Air Handling units AeroMaster XP

## XPRJ and XPRF Sections

Firmly adjusted heat element thermostat equipped with a bimetal sensor. Opening contact 15 °C (closing at 5 °C) Closing contact 50 °C (opening 40 °C) - to enable fan connection.

- Degree of protection IP20
- Max. switched output AC 230V 5A

Chamber air-conditioning unit (AC 230V/50 Hz, 2A, start max. 15 A) equipped with operation thermostat (set to range 20 °C -46 °C).

- Cooling output (L35L35 -DIN 3168): 850 W
- Cooling output (L35L50 -DIN 3168): 620 W
- Degree of protection IP54
- Input: 290W (L35L50)
- Temperature range of cooled air: +25/+45 °C
- Permissible ambient temperature: -20/+55 °C
- Noise radiated to the surroundings: 65 dB(A)
- Weight: 26 kg

## Safety Labelling

The service door and removable cover are labelled with a lightening bolt symbol and text:

**„ATTENTION! ELECTRICAL DEVICE“**

Spots intended for the grounding connection are labelled with a grounding symbol.

Figure 5 - Safety labels



## XPTG section (Gas Heater)

### Section description

The casing of the section is made of aluminium frame sections and 50 mm thick thermally insulated panels.

The air is heated by flowing around the combustion chamber and its tube plate.

A flange for the burner mounting is situated on the front (service) side of the heat exchanger. The flue gases are drawn off via the chimney outlet (optionally on the rear side of the section). Sections are manufactured in two versions - either with or without the bypass. The bypass version is equipped with a damper to regulate air flow. Furthermore, the gas heater section is provided with a condensate drain outlet (1/2" pipe).

This section can be delivered for indoor as well as for outdoor use.

The burner and triple safety thermostat of the outdoor version are protected by covers.

A burner operated in an outdoor environment up to -20 °C must be provided with a heating cable switched by the thermostat. As standard, this set is included in deliveries marked as TKW 53 for burners WG 10, WG 20, or as TKW 88 for burners WG 30, WG 40.

A burner operated in an outdoor environment from -20 °C to -40°C must be equipped with a special heated cover of the burner and a burner flange for the external air inlet

### Burner closed heated cover installation

The external air inlet to the burner's extension is made from a Spyro hose. An aperture in the burner cover for the hose must be created in the appropriate location; the hose must be sealed in this aperture. Inlet air must come from the heated room.

The SK 3102.000 300 W heating equipment will be attached on the heater panel under the burner valve block using a holder (enclosed, including 4 screws). Electrical connection will be made using a seven-pin connector at the burner. The heating power supply is ensured directly from the burner; therefore, the burner's "L" terminal must always be under voltage.

The thermostat of the burner cover is set to 5 °C. If the cover's temperature drops below the pre-set temperature, the heating is switched on.

### Connection of Gas Heater

The XPTG gas heater section must be connected to the air duct via a dilatation insert heat resistant up to 200 °C. The gas-flue ducting must comply with all applicable directives and standards of the state of installation (for CZ - ČSN 73 4201 and ČSN 73 4210), and must be performed by a specialized provider. For information on installation, commissioning and inspections of the gas indirect heater and burner, refer to the special Installation and Operating Instructions which are included in the accompanying documentation of the air-handling unit. Safety and control elements delivered with the section must be connected to ensure proper, reliable and safe operation.

Table 2 – included M&C components

Component	Place of installation	
Pt100 - flue-gas temperature sensor	to the flue-gas exhaust(flue-gas duct)	it must be installed during device assembly
ESD36 - triple thermostat	gas heater section (behind the heat exchanger, following the airflow direction)	installed by the manufacturer
TH 167 - emergency thermostat	just preceding the gas heater section	it must be installed during device assembly
NS 120 - inlet air temperature sensor	behind the gas heater section, e.g. in the ducting 3 m behind XPTG section, to allow the air to be mixed	it must be installed during device assembly
NS 120 - flue-gas temperature sensor	behind the gas heater section, e.g. in the ducting 3 m behind XPTG section, to allow the air to be mixed	it must be installed during device assembly



## XPTG section (Gas Heater)

### Gas Heater Section Start-Up

The gas heater is a special gas device which is characterized by a special activation procedure (commissioning). After completing the air-handling unit installation, it is necessary to place a separate order for the gas burner activation with the gas heater manufacturer or their representative. In addition to the gas burner adjustment, the interconnection of safety thermostats and the control circuits of the gas burner and air-handling unit (fans) must be checked during the gas heater commissioning. A commissioning report, which also includes settings of the gas heater temperatures and the results of testing of emergency and safety components, must be drawn up upon putting the gas heater into operation.

Separate documentation from the combustion chamber manufacturer is delivered with this section.

**Never start up the gas heater section if the air-handling unit is stopped, otherwise the hazard of local overheating of the air-handling unit will occur, which can damage some components (e.g. drop eliminator).**

Figure 1 – Burner heated cover dimensions

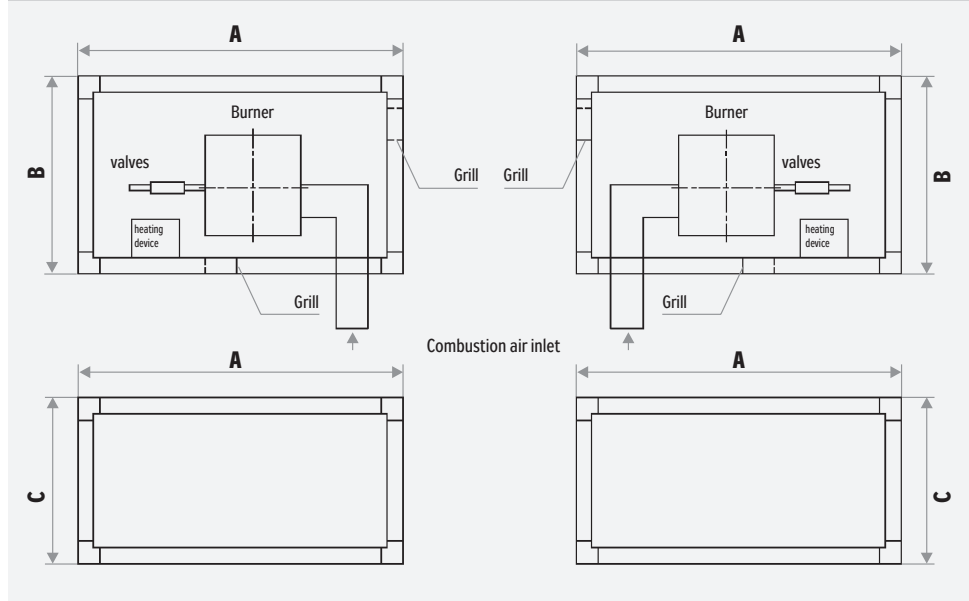

Table 2 – Burner heated cover dimensions and weights

Burner type	A [mm]	B [mm]	C [mm]	Weight [kg]
WG 10 and WG 20	1020	620	520	cca 50
WG 30 and WG 40	1590	790	820	cca 110
65	1590	790	1000	cca 125

# Air Handling units AeroMaster XP

## XPXB 28/BS Plate Heat Exchanger Section

### Additional installation of the heat exchanger block

The heat plate heat exchanger section is delivered without the plate exchanger, bypass damper or bypass sheets installed.

Figure 1 - XPXB 28/BS plate heat exchanger section

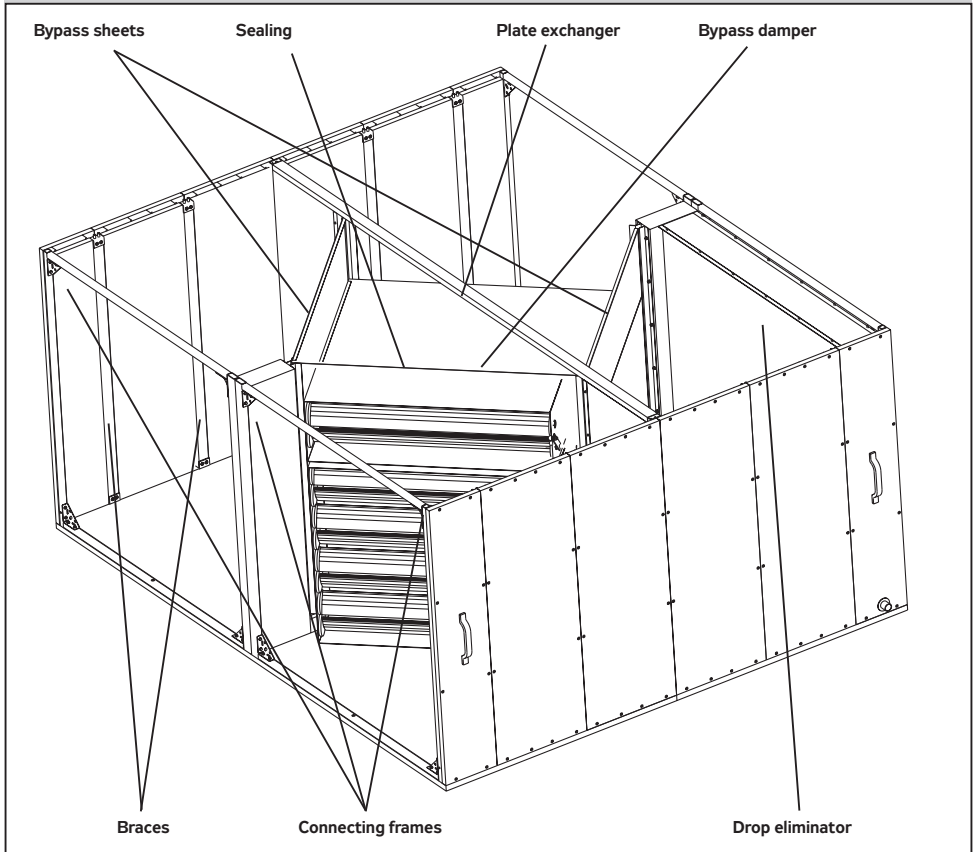

Figure 2a - XPXB 28/BS section casing

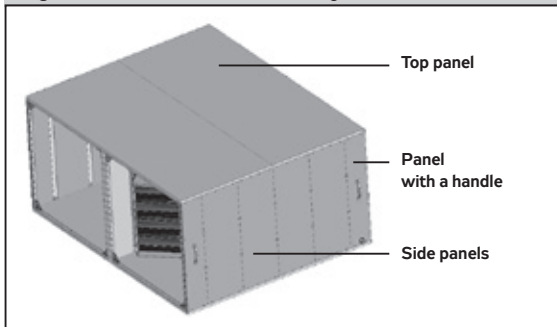
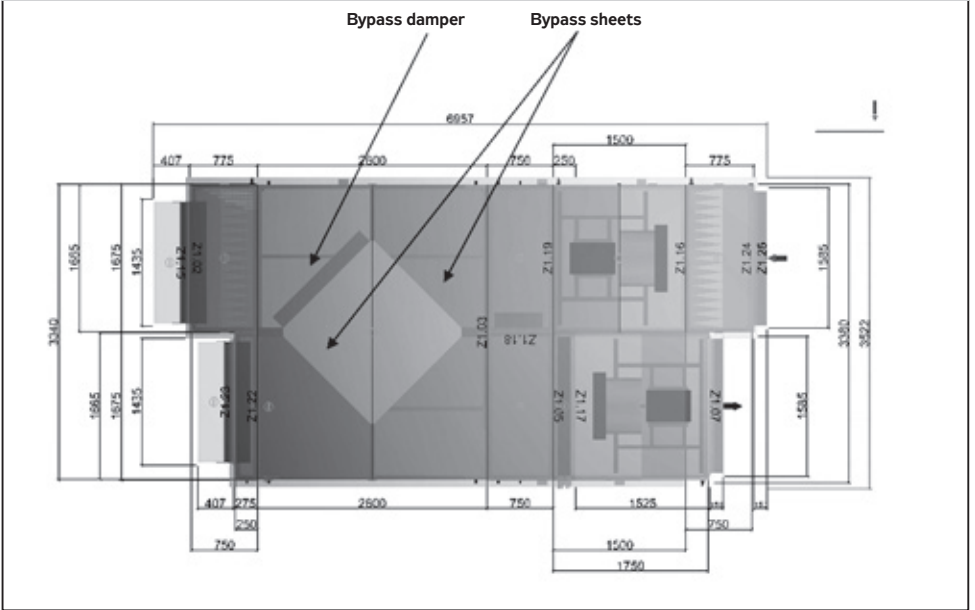

Figure 2b - Drop eliminator



## XPXB 28/BS Plate Heat Exchanger Section

Figure 3 – Air-handling unit top view



### Plate Heat Exchanger Installation

- Dismount side panels and panels with handles (see figure # 2).
- Loosen upper screws of braces and connecting frames (see figures # 4, 5 and 6).
- Dismount top panels (on block as one large plate) (see figure # 2).
- From upper side, insert the plate exchanger (see figure #1).
- From upper side, insert the bypass damper (see figure #1).
- Stick the sealing onto the upper edge of the bypass damper (figure # 1).
- Reinstall top panels - as one plate (see figure # 2).
- Screw in upper screws of braces and connecting frames (see figures # 4, 5, 6).
- Fix bypass sheets into the space between top panels and exchanger - use 4.8 x 16 self-tapping screws (see figure # 1).
- Seal with silicone sealant.
- Slide the drop eliminator into the air-handling unit - guiding bars of the condensate draining tray (see figure # 1).
- Reinstall and screw on side panels and panels with handles (see figure # 2)

*Note: The panel handles are delivered dismantled to avoid damage during the transport. The handles and connecting screws are included in the installation kit. The installation holes for screws in panels are prepared in the factory.*

Figure 4

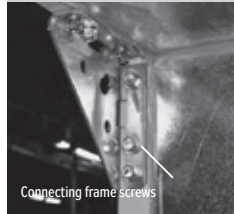

Figure 5

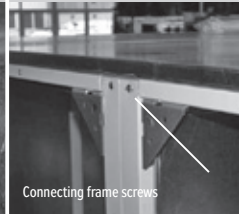

Figure 6

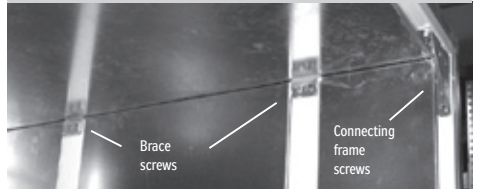

Figure 7



Figure 8



# Air Handling units AeroMaster XP

## XPXR Regeneration Exchanger Section

### Use

Rotary regenerative heat exchangers are used for heat recovery, and are designed to transfer heat (non-hygroscopic version), or to transfer humidity (hygroscopic version) while simultaneously maintaining the ability to transfer heat from the outlet air to the inlet air. The heat or humidity transfer takes place in the rotor, one half of which reaches into the hot outlet air flow and the other half into the cold inlet air flow. As the rotor turns, the heat-exchange surface of the heat exchanger passes in turn through the outlet and inlet air flow, and thus heat or heat and humidity transfer is enabled.

### Operating Conditions

- XPJR and XPFR rotary heat exchangers are designed to be installed within the AeroMaster XP air-handling unit. Use and operating conditions are related to the entire AeroMaster XP air-handling unit, and they are specified in the air-handling unit's documentation.
- Heat exchangers are designed to transfer air heat at temperatures ranging from -20°C to +55°C, or up to +100°C if made to special order.
- Operation at temperatures below -20°C is possible providing antifreeze protection of the heat exchanger is ensured (refer to the section Heat Exchanger Antifreeze Protection).
- Maximum velocity of transported air through the rotor is 4.0 m/s (checked just after the rotor). A version for higher air velocities with a reinforced rotor can be ordered for an additional charge.
- Inlet and outlet air for the heat exchanger must be filtered to avoid fouling of the rotor's cells.
- To enable servicing, maintenance and cleaning of the heat exchanger, it is necessary to provide a service access from both sides of the heat exchanger by inserting the access section (service section, filtration section, etc.) in the air-handling assembly, respectively to enable the heat exchanger to be pushed out of the air-handling unit (more than 1/2 of the heat exchanger construction width).
- The flushing chamber carries out its function only if the directions of the inlet and outlet air flow oppose each other. The flushing chamber is always situated on the inlet air side behind the heat exchanger.
- If ordered and for an additional charge, the heat exchanger can be fitted in the factory with a collecting tray for condensate draining.

### Design

The heat exchanger rotor is made of thin aluminium sheet in enthalpy version with sorption coating, and it is driven by a belt. The rotor shaft is supported by ball bearings, respectively taper roller bearings. The reinforced frame of the heat exchanger is made of galvanized sheet steel. The rotor is sealed to the flushing chamber by special brush sealing. The external casing is created by 25 mm sandwich panels filled with mineral wool; the panels can be delivered either galvanized or with painted face sides.

### Handling and Transport

Increased attention must be paid to the safety of persons as well as of the product when handling the rotary heat exchanger, which due to its dimensions (tall and narrow), weight and high centre of gravity is very unstable. The manufacturer recommends always fixing the position of the rotary heat exchanger with suitable roping if it is not assembled in the section assembly! The rotary heat exchanger can only be stored, transported or handled in the vertical position. Any tilting leading to a change in the position of the rotation axis may damage the rotor's evenness and bearing beddings. If the section dimensions exceed the height of the truck, it is necessary to cover it with an additional tarpaulin.

Larger heat exchanger sizes can be lifted using a crane. There is a space provided in the base frame to fasten lifting straps (see figure). The lifting straps must be protected by sleeves. The product can be transported by forklift truck only if secured against falling.

Figure 1 – Handling the heat exchanger

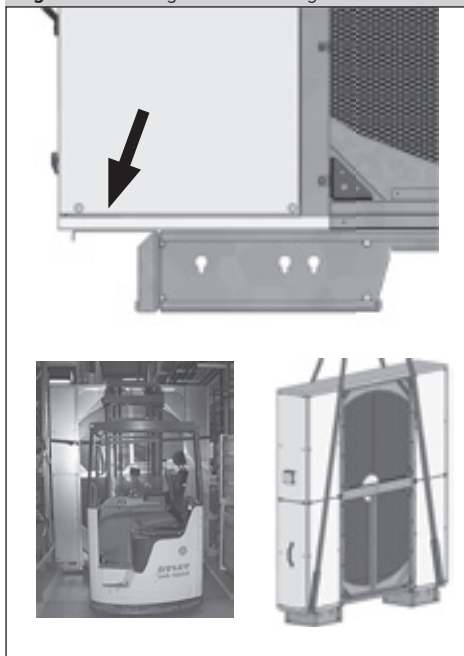

### Installation Site

The surface of the site for the air-handling unit installation must be level and flat. Maximum misalignment of the floor or supporting structure intended for the air-handling unit installation must not exceed 1 mm per 1 meter. Observance of this condition is important for installation as well as for the air-handling unit operation.

To enable regular servicing, maintenance, guarantee and post-guarantee servicing, it is necessary to provide a service access from both sides of the heat exchanger's rotor.

## XPXR Regeneration Exchanger Section

If this is not enabled by the air-handling unit assembly arrangement, the air-handling assembly must be designed so that the heat exchange can be pushed out from the air-handling assembly. Minimum required space is 1.15 x width of the XP air-handling unit.

### Removing the Rotor Fixation

The heat exchanger rotor is in its upper part fixed with two clamping bars to avoid dynamic loading of the rotor during the transport. These two bars must be removed before the heat exchanger installation.

Figure 2 – Rotor Fixation Removal



Figure 3 – Frame height adjustment

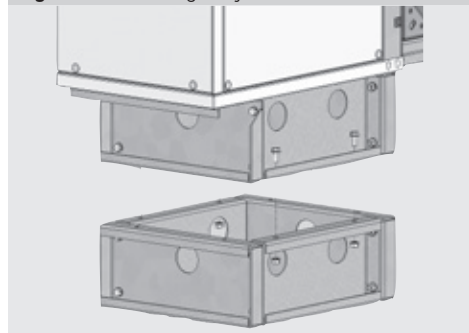

### Installation

During installation, it is ESSENTIAL to retain alignment of the AeroMaster XP unit and rectangularity of the heat exchanger. Failing to maintain the above-mentioned condition will result in rotor displacement, which will influence the tightness and service life of the air-handling assembly. If 300 mm or 400 mm base frames are used, it will be necessary to install a separate foot on the heat exchanger base frame before installing the heat exchanger in the assembly to eliminate the height difference (see figure # 3).

It is advisable to connect one side of the heat exchanger to the assembly first and then check the rotor alignment (the distance between the wheel circumference and face walls must be aligned and the rotor must not drag in any position when freely rotated). If any problem occurs, wheel centring must be performed, refer to the section Troubleshooting (if you have any questions or doubts, contact the manufacturer's service department).

The limits are as follows:

- Depressing the brushes to 1.5 mm (i.e. the distance of the brush plastic bar from the face sheet).
  - The gap between the brush and the face sheet: 1.0 mm.
- If the brushes are not tight, they can be adjusted by changing the position of the plastic support bar

*Warning: A rotary heat exchanger is one of the most expensive components in an air-handling assembly; poor and/or incorrect installation can result in costly repairs. Misalignment can be caused by improper handling during transport and/or failing to observe conditions for its correct installation. If the misalignment prevents free rotation of the rotor, the rotor will have to be centred using a centre screw. If this is the case, contact the manufacturer of the air-handling device.*

### Wiring

To connect the heat exchanger to the power supply, use the terminal box situated on the side panel above the service panel.

The heat exchanger's operation can be controlled by a frequency inverter as follows:

- Autonomous control using an FIA controller
- Control using a frequency inverter (XPFM) and a control unit

When positioning the frequency inverter, observe its operating conditions (degree of protection, temperatures, wiring harness, etc.) in accordance with the accompanying documentation, respectively the type plate.

Connection without control - 3x400 VD/50Hz; connection with the supplied frequency inverter - 3x230 VV/50Hz.

### Commissioning

Before the first start-up, perform the following checks:

- the rotor and exchanger's frame alignment.
- Check the rotor for free rotation.
- Belt tension
- Close fitting of sealing brushes
- Check the motor for correct wiring.
- Motor running direction
- Input current of the motor (refer to the type plate)
- When handing over the air-handling unit, create records of operating staff training, operation, inspections and cleaning of the rotary heat exchanger in accordance with this document (subject to guarantee validity).

### Regular Inspections

Before starting maintenance, cleaning and/or any service work on the rotary heat exchanger, it is essential to disconnect the power supply and take precautions to avoid the accidental switching on of the motor during performance of these works.



**The manufacturer prohibits stopping the exchanger wheel equipped with a layer of silica gel throughout the year.**

## XPXR Regeneration Exchanger Section

Figure 4 – Heat Exchanger Wiring Diagram

### FIA Controller

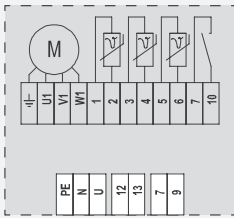

- 1...6  
-Terminals for connection of temperature sensors (connected as standard)  
7, 10  
-Terminals for connection of speed detector (connected as standard)

- U, PE, N  
- Power supply section terminals of the heat exchanger with autonomous control 1f:230/50Hz 12, 13  
- Remote signalling terminals of the rotary heat exchanger status (12, 13 closed – for disconnected power voltage or failure status) 7, 9  
-Terminals for connection non-potential contact for the heat exchanger switching (START) U1, V1, W1  
-Motor connecting terminals (connected as standard)

### XPTG Section (gas heating):

Involvement of the gas burner and triple thermostat must be carried out in accordance with the documentation on these devices. Relevant documentation is included in the accompanying technical documentation of XP unit.

### XPFM Control

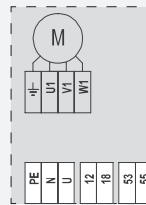

- U, PE, N  
- Power supply section terminals of the heat exchanger with frequency inverter control 1f:230/50Hz 2, 3  
- Terminal for connection of control signal 0-10V DC 6, 9  
-Terminals for connection non-potential contact for the heat exchanger switching U1, V1, W1  
-Motor connecting terminals (connected as standard)

### No control

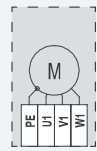

- U1, V1, W1, PE  
- Power supply section terminals of the heat exchanger 3f:400/50Hz

Rotary heat exchanger condition inspections must be performed regularly; checking the rotor for cleanliness is the most important part of these inspections. To monitor the heat exchanger rotor fouling, it is advisable to perform regular checking of the heat exchanger rotor pressure loss. The heat exchanger rotor pressure loss must not exceed 15% of the pressure loss value measured on a new rotary heat exchanger. The user will determine the intervals for regular inspections according to the operating conditions, however, at least once every 3 months. At the same time, the user must perform the following checks:

- Check the functionality.
- Check the rotor for cleanliness.
- Check the sealing brushes for tightness.
- Check the rotor condition and tension of the driving belt.
- Check fouling of filters; inlet and outlet

If fouled or damaged, the filters must be replaced with new ones immediately. If any fouling of the rotor is found, the user must ensure its expert cleaning. Failure to perform maintenance can result in permanent damage to the rotary heat exchanger rotor and very expensive repairs.

### Heat Exchanger Antifreeze Protection

At very low temperatures, usually from -15°C to -20°C, the heat exchanger will start to freeze on the outlet side (hot and moist air will condense on the cold rotor surface). Excessive ice build-up can restrict the air flow through the rotor to such an extent that the heat exchanger pressure loss exceeds the bearing capacity, causing the rotor to collapse (tearing of the reinforcement bars from the rotor centre). The general rule is that the thermal capacity of the heat exchanger directed from the room towards the outdoor space must be higher than the thermal capacity coming in. The following antifreeze protections can be used with rotary heat exchangers:

- Speed control or safety turning off of the heat exchanger
- Inserting a preheating device on the cold air side

Downward speed control using a frequency inverter can reduce the heat (cold) transfer and thus adjust the thermal capacities of the heat exchanger above freezing level. The advantage of this solution is that the heat exchanger is not stopped. If antifreeze protection without output control (FI) is used, the rotor will be stopped if frozen, and simultaneously the entire heat transfer capacity through the heat exchanger is stopped, too. So heat exchanger antifreeze protection can be resolved as follows:

- By rotor speed control using a step-less controlled frequency inverter and a temperature sensor (reading the outlet air temperature behind the heat exchanger).
- By monitoring the heat exchanger pressure loss and stopping it (without FI, or with FI FIA).
- Using a preheating device

### Heat Exchanger Cleaning

There are several ways of how to clean rotary heat exchangers, including specially adapted cleaning machines. An appropriate cleaning method must be chosen depending on the level of rotor fouling. In normal conditions, the rotor has a certain self-cleaning ability due to continuous changing of the air flow direction (inlet x outlet). The flushing chamber prevents particles from the outlet air from passing due to rotation into the inlet air. However, this flushing chamber does not in any way contribute to rotor cleaning. If the sealing brushes are properly installed, they will help in cleaning (sweeping) the heat exchanger face surface. The most frequently used cleaning methods are:

- Cleaning using compressed air
- Cleaning using compressed water
- Steam cleaning
- Combined cleaning using hot water/compressed air



**Improper cleaning process leads to serious threat of major damage to the exchanger rotor!**

## XPXR Regeneration Exchanger Section

**Figure 5** – methods of exchanger rotor cleaning

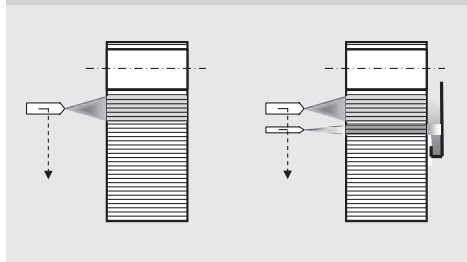

Compressed air can only remove dry, fibrous or larger particles. Material loosened during cleaning must be constantly removed from the entire chamber of the heat exchanger. Cleaning must always be performed following the air flow direction. Sticky dirt can be removed by water. According to the type of fouling, cold water, water with detergent, hot water or compressed steam can be used. The need for water draining is a disadvantage of this type of cleaning. Combined cleaning using water and compressed air can be used to collect the water running down from the rotor; the air nozzle situated under the water nozzle enables the water, including the dirt, to be carried off by the air flow into the collecting canister situated on the other side of the rotor. To clean heavily fouled rotors and/or to avoid damage to the rotor caused by an unqualified approach, we recommend hiring a specialized provider to clean the heat exchanger. During the service life of heat exchangers equipped with an enthalpy coating, tiny particles of enthalpy coating can loosen. This is not a fault, and the quality of heat and humidity transfer is not affected.

### Troubleshooting

#### Rotor Damage

Rough and/or improper heat exchanger handling, exceeding maximum permissible air flow velocities as well as neglected maintenance can lead to permanent damage to the rotor, i.e. causing the wound layers to slip down, the reinforcement rotor spokes to break and the entire rotor to collapse. In these cases, expensive rotor replacement is inevitable.

#### Rotor Centring

This procedure summarizes the minimum requirements for the heat exchanger rotor centring. The following conditions must be met:

- The heat exchanger rotor is axially attached to the frame using M16x30 bolts - wrench #24 is needed.
- Access to the rotor centre is enabled through the adjacent sections in the upper duct line.
- If access through the adjacent sections is not possible, these sections must be pulled out or removed from the air-handling unit assembly.

**Figure 6** – Access to the rotor shaft bolt

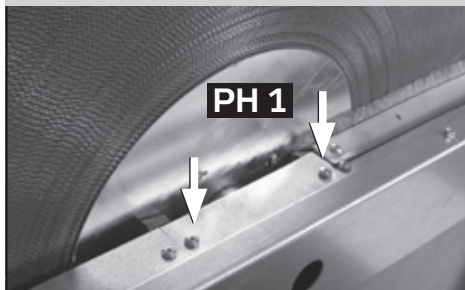

#### Step 1:

Release and remove the cover of the bolt; it is necessary to use a PH 1 tool.

*Note: In some cases, it is possible to centre the rotor from one side; otherwise, it is necessary to have access to the bolts on both sides of the heat exchanger.*

#### Step 2:

Basically, there are two ways of how to centre the rotor depending on the position and access to the shaft bolt:

##### ad a)

At least two persons are needed for the following procedure. Slowly loosen the bolt using a ring spanner. Turn a minimum of 1 to 2 turns, but no more! Never remove the bolt entirely! With an open palm, push the rotor into the required position. (Use gloves!) In this case, the weight of the heat exchanger rotor can also be conveniently used to adjust it to the proper position. Firmly tighten the shaft bolt and check the position.

**Figure 7** – Tighten the shaft bolt using wrench # 24



##### ad b)

This way of centring is much more precise. The following centring procedure requires a tightening belt to be used; the belt length can be 4 to 8 meters depending on the rotor size. This centring procedure can be performed by just one person; however, the following preliminary actions are necessary:

- Disconnect the power supply
- Remove the 4 side panels



## XPXR Regeneration Exchanger Section

*Note: The panel with interconnecting box can only be released, not removed from the heat exchanger frame. The rotary heat exchanger must be disconnected from the power supply!*

**Figure 8** – Access to centre the rotor

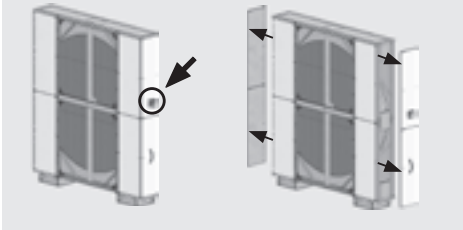

- Run the tightening belt under the heat exchanger rotor and attach it to both frame braces. Pulling the belt, shorten its length and tighten it against the rotor (see figure).

**Figure 9** – Supporting the rotor using a tightening belt

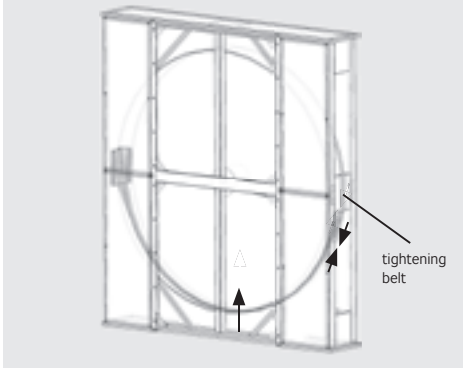

- Slowly loosen both shaft bolts using a ring spanner. Turn a minimum of 1 to 2 turns, but no more! Never remove the bolt entirely!
- With an open palm, push the rotor into the required position. (Use gloves!) The rotor can be raised by tightening the belt.
- Firmly tighten both shaft bolts and check the position. Then release the tightening belt.

### Step 3:

Check all sealing brushes around the rotor circumference as well as in the dividing plane and around the flushing chamber circumference. If any leaks are found, adjust the sealing brushes by shifting the plastic bars to the new position. An SQ2 (square) tool is required to loosen the brushes.

### Step 4:

Reassemble and reconnect all removed parts.

## Belt Replacement

If damaged or broken, the driving belt must be replaced with a new one. A new driving belt can be obtained as a spare part which must be thermally connected together. A special tool can be used to connect the driving belt safely. For quick connection of the driving belt, you can use a common lighter. To do so, follow the procedure below. Before replacing the driving belt, ensure the heat exchanger is disconnected from the power supply.

*If the driving belt has broken, the heat exchanger rotor will stop but the motor and pulley will continue to run!*

1. Paste the new driving belt with adhesive tape to the rotor.
2. Rotate the rotor to wrap the driving belt around.
3. Measure the driving belt length, including the pulley.
4. Shorten this driving belt length by 8% (e.g. for L 2.500 mm = 200 mm).
5. Melt simultaneously both driving belt ends. (Use a contact iron at  $\approx 400\text{ }^{\circ}\text{C}$  or above a lighter flame; do not set the belt on fire!)

**Figure 10** – belt connection

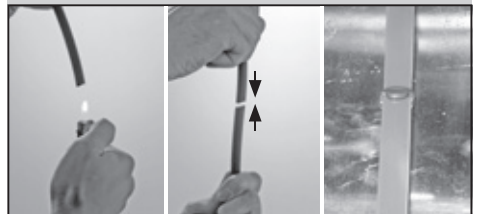

6. Press the driving belt ends together to connect them.
7. Let the connection cool down.
8. Check the proper position of the driving belt around the rotor.
9. Pull the driving belt down, a 0.5 m log rod can be used, and put it on the motor pulley. Put the rod through the driving belt loop and lodge its end against the heat exchanger frame. Push the rod down towards the heat exchanger base and apply tension to the driving belt to pull it down and put it on the pulley from below. Pull the rod slowly up and remove it.

**Figure 11** – belt replacement

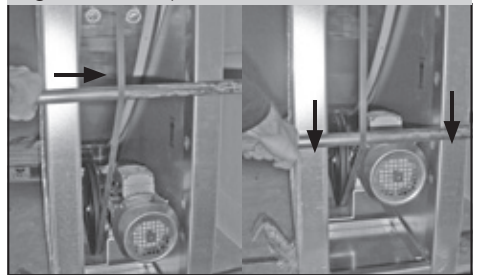



## Stacks of AeroMaster XP Air Handling Unit Sections

### Recommended unloading procedure of stacks of AeroMaster XP air handling unit sections from a truck and their dismantling

Stacks of XP sections can be unloaded from a truck using a forklift truck and placed on a flat floor. Then remove the protecting foil, fastening strips and cardboard, and follow the instructions below.

#### Upper section unloading

##### 1.a) A section without a base frame placed on the lower section without the pallet

Using the forklift truck, lift the empty pallet with cardboard up the level of the bottom edge of the upper section, and push it against the lower section side, see figure # 1. Then shift the upper section onto the pallet ready, see figure # 2 and 3. The pallet must be of the same or larger size than the platform of the unloaded section. For XP04 and XP06 sections up to 1.2 m long, use a 0.8 × 1.2 m pallet.

On customer request, we can deliver suitable pallets for section platforms larger than 0.8 × 1.2 m, or the customer can make his own pallets of suitable dimensions himself.



The pallet ready for shifting the upper section onto it

Shifting the upper section onto the pallet

The upper section placed on the pallet

##### 1.b) A section without a base frame placed on the lower section with the pallet

This section placed on the special pallet can be unloaded using a forklift truck. Before unloading the upper section, it is necessary to unscrew the wood screws and remove the side boards.

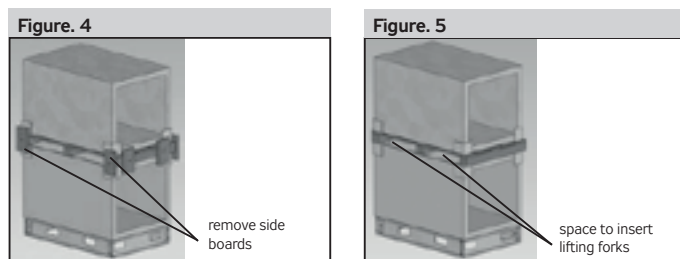

#### 2. Sections equipped with a base frame

The sections with a base frame are stacked using an interspacing frame. Before unloading the upper section, it is necessary to unscrew the wood screws, remove the side boards and unscrew the screws in the base frame. The openings in the base frame are suitable for forklift truck forks. Insert the forks into these openings and unload the section.

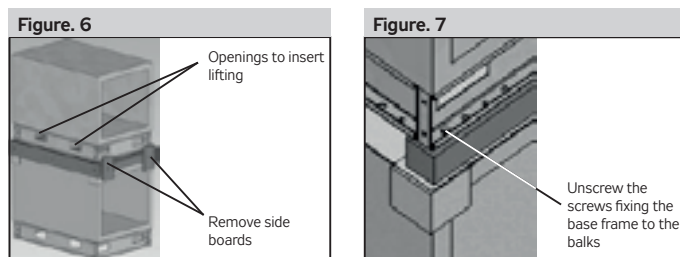

# Air Handling units AeroMaster XP

## AeroMaster XP Air Handling Unit Adjustable and Fixed Feet

Adjustable legs are used for the base frame height of 300mm and 400mm. When levelling the unit due to floor unevenness or other reasons, the base frame height off-set must not exceed -20 mm to +5 mm. The adjustable legs are provided with a levelling nut and joint. To ensure the unit's stability, the leg declination must not exceed 10°.

Adjustable feet are delivered separately due to transport safety. For the same reason, the fixed feet of some sections or transport blocks may also be disassembled in the factory. The customer will install the adjustable or fixed feet himself

### Recommended Installation Procedure

- To install the adjustable (see figure # 1) or fixed (see figure # 2) feet to the 150 mm base frame, place the section or transport block of sections on supports (balks or stands) which must be stable to avoid the section overturning during the feet installation. The supports must be placed min. 250 mm from the base frame edges.
- Mount the foot using four M8 x 20 screws.

Figure 1

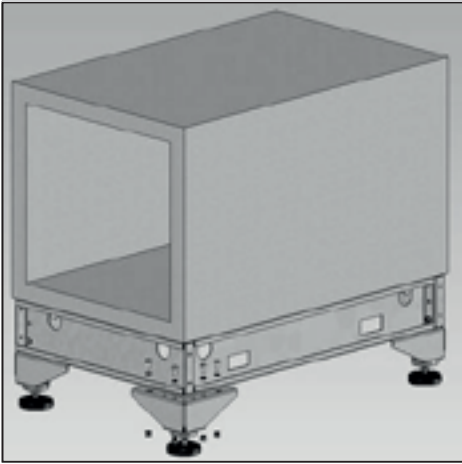

Figure 2

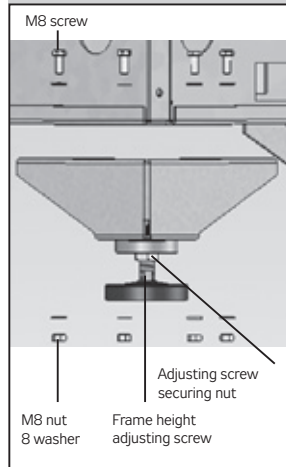

Figure 3

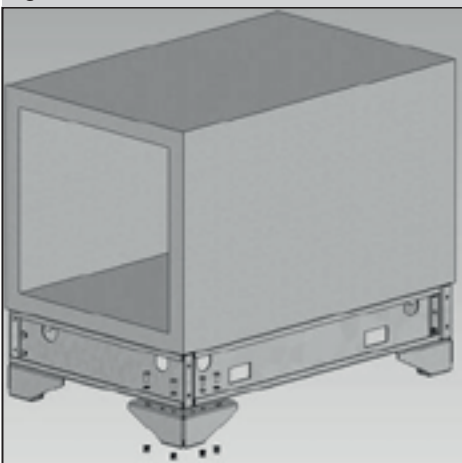
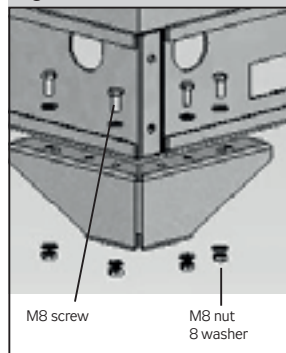

Figure 4



## Removing the transport brace

### Procedure of removing transport brace

The transport brace is mounted externally on AeroMaster XP 10, 13, and 17 units, on the side panels of a length of 1250 mm and more, for AeroMaster XP units 22 and 28, then all the side panels of size 1000 mm or more.

**Figure 1** – Overall view of mountet transport brace

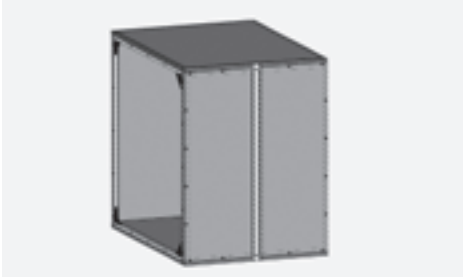

**Step 1:** Remove the screws and washers

**Figure 2** – deassembly of screws and washers

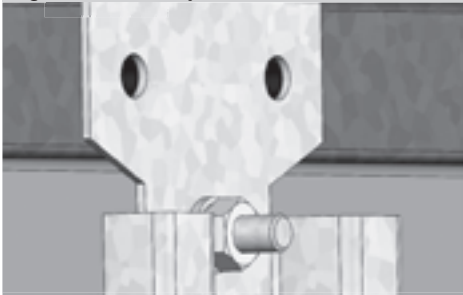

**Step2:** Remove the brace. Cover the rivet nuts with nut caps. cover the remaining holes on the side panel with a nylon holster. Nut caps with nylon holster can be found in a bag attached to the brace.

**Figure 3** – removing the brace

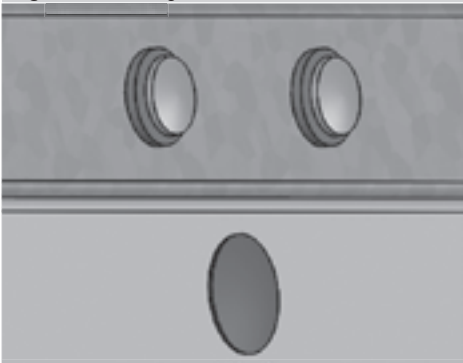

# Air Handling units AeroMaster XP

## Air Flow Rate Determination for Fans with Overhung Impeller

After installing and commissioning the equipment air flow may be checked or possibly adjusted using simple method for measuring at diffuser. This method eliminates to some extent errors in results determined by speed measurements in a wind tunnel, which are caused mainly by turbulent and non-linear air flow. For the diagram of the measurement determination of the difference in the static pressures in front of the inlet fan diffuser and in the fan diffuser, refer to figure #1 (2).

Figure 1

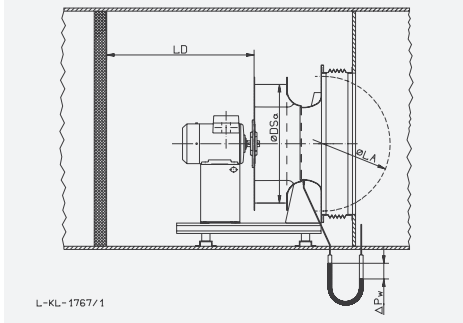
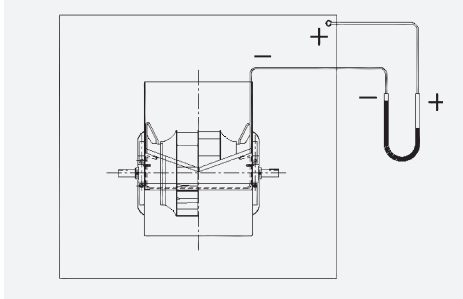

Figure 2



Impeller type	k factor
RH 25 C	60
RH 28 C	75
RH 31 C	95
RH 35 C	121
RH 40 C	154
RH 45 C	197
RH 50 C	262
RH 56 C	308
RH 63 C	381
RH 71 C	490

Impeller type	k factor
ADH-E_0160	137
ADH-E_0180	178
ADH-E_0200	203
ADH-E_0225	246
ADH-E_0250	282
ADH-E_0280	353
ADH-E_0315	441
ADH-E_0355	504
ADH-E_0400	684
ADH-E_0450	811
ADH-E_0500	1090
ADH-E_0560	1283
ADH 630	1568
ADH 710	1776
ADH 800	2443
ADH 900	2939
ADH 1000	4182

Impeller type	k factor
RDH-E_0180	112
RDH-E_0200	64.8
RDH-E_0225	86.2
RDH-E_0250	123
RDH-E_0280	157
RDH-E_0315	207
RDH-E_0355	277
RDH-E_0400	379
RDH-E_0450	505
RDH-E_0500	634
RDH-E_0560	875
RDH 630	1091
RDH 710	1306
RDH 800	1571
RDH 900	1904
RDH 1000	2542
RDH 1120	3367
RDH 1250	4193
RDH 1400	5260

qv – air flow rate

k – fan factor (provided by the fan manufacturer)

Δp<sub>w</sub> – static pressure difference (measured value)

ρ<sub>op</sub> – air density at operating temperature

The (fan) air flow rate can be calculated according to the following relationship:

$$\dot{V} = k \cdot \sqrt{\Delta p_w} \cdot \rho_w$$

If the fan is operated at temperatures higher than 20°C, the air flow rate will be calculated using the following relationship:

$$\dot{V} = \sqrt{\frac{\rho_{20}}{\rho_{op}}} \cdot k_{20} \cdot \sqrt{\Delta p_w} \cdot \rho_w$$

## Connection of individual sections – complementary set XPSSSxxDR

If the installation does not allow disassembly of the side panels on the non-serviceable side, it is possible to order a complementary connecting set, XPSSSxxDR (internal). When ordering this set, it is necessary to specify its type XPSSSxxDR (xx - specifies size of XP product) and number of connections, e.g. XPSSS06DR - 2 pcs.

The connecting set is installed on the inner side of the vertical profiles of the XP connecting frame.

If ordered, the complementary assembly set will be installed in the factory in the corresponding sections on the vertical profiles of the connecting set XPSSSxxMR.

Figure 1



Figure 2



Figure 3

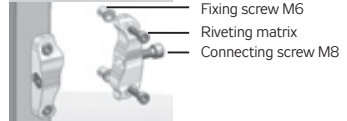

## Automatic Backup of Fan Motors

A fan section, respectively a built-in fan assembly, with a backup motor (drive) for the "backup" function is equipped with two motors situated in one fan section; each motor belt drive leads to the common shaft of the fan. The backup function is designed so that the main motor runs in basic mode while the second/backup motor will only run if the main motor fails.<sup>1)</sup>

The backup is ensured by automatic start-up of the backup motor if the main fan motor has failed.

The backup mode will be activated if the air flow (supply) is interrupted during the air-handling unit operation, which can be caused by the following reasons:

- a) The main motor belt has broken - air flow failure.
- b) The main motor has failed - overheating, open thermo-contacts, shorted motor, etc.
- c) The frequency inverter has failed (if equipped).

Due to application purposes (i.e. guaranteed air-handling unit operation), the fans with backup motors are equipped with protective inlet grilles to protect the fan impeller (blades) from being damaged by the remains of a torn belt (of the main motor).

Figure 1

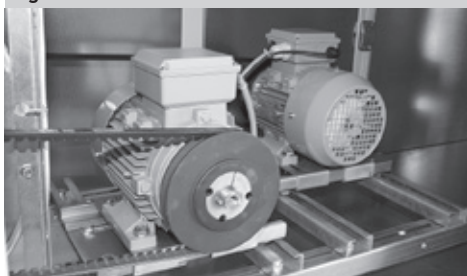

## REMAK Control Systems for Backed-Up Air-Handling Units

The backup fan section is always equipped with two dP air flow sensors. One sensor is assigned to the main fan motor while the other is for the backup fan motor. Information on a main motor failure from the assigned sensor is sent, as a warning signal, to the control unit terminals. These terminals must be used for a visual or an acoustic alarm situated in a suitable location to inform the operating staff that the backup mode has been activated. This failure is not signalled in the control unit. As soon as the main failure has been registered, the backup motor is started and the air-handling unit OPERATION will continue in the backup mode without interruption and without need for the operator's intervention.

This mode will last until the main fan motor failure is rectified; the unit must be switched off (i.e. reset sequence must be carried out). The main motor restart (e.g. after cooling down) is disabled; the main motor can only be restarted after the air-handling unit has been switched off and checked, the failure rectified, and restart of the unit carried out. Direct transition from the backup mode to the basic mode is not possible. If air pressure is reduced or lost because of belt breakage or motor failure (overheating, thermo-contact opening) during the backup mode, the air-handling unit will be switched to STOP mode, which will be signalled acoustically as well as visually by the control unit in a standard way, respectively using optional external outputs of failure signalling (other than those used for the backup mode signalling). If the drive has been switched to the backup motor (backup mode), it is necessary to check the fan's built-in assembly, including its drive, rectify the main drive failure, and if necessary replace damaged parts, and restart the unit (in the basic mode); when doing so, remember to observe all safety measures. The backup motor is intended only for temporary operation if the main motor fails (this feature can differ depending on the M & C system).

### Warning:

When connecting the fan section with a backup motor, it is necessary to be careful and strictly observe the M & C project requirements. It is especially necessary to pay attention to the wiring! If a service switch is used, it must be of the duplex type for safety reasons, i.e. it must enable both motors to be switched off at the same time.

<sup>1)</sup> The backup motor concept does not provide regular alternation of motors as far as the equivalent number of operating hours is concerned. Moreover, due to the backup design (without a clutch) both motors always turn. Backup reliability is ensured by idle turning of the backup motor during the basic operation mode and extended belt length of the backup motor (reduced wear). Of course, regular maintenance must be preformed (belts, bearings). When performing regular or occasional servicing, it is advisable to replace both belts; respectively, if the broken main motor is being replaced, use the backup motor to replace the main motor and a new one to replace the backup motor. The broken main motor must be replaced as soon as possible and the air-handling unit must be recovered in basic operation mode with the backup function available.

# Air Handling units AeroMaster XP

## Compact version of Air-Handling Units

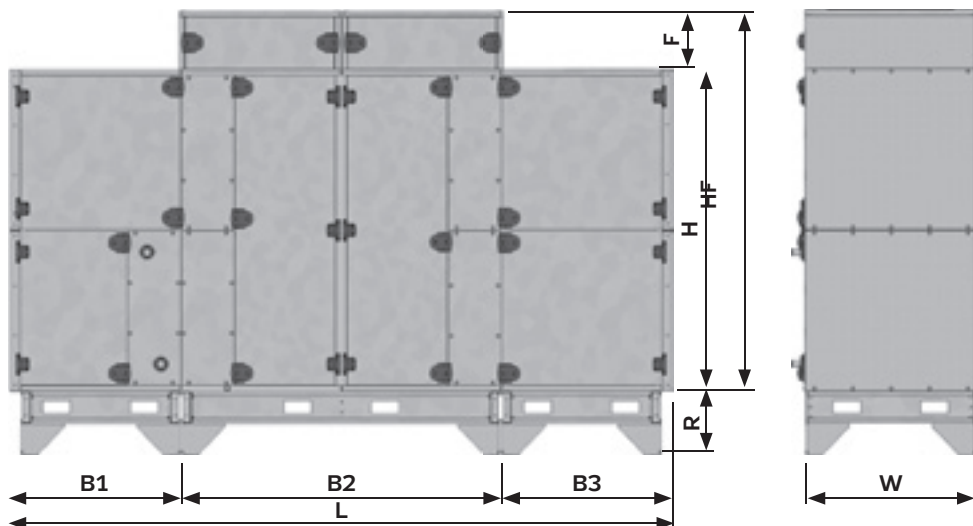

### Dimensions and weights

DIMENSIONS AND WEIGHTS										
	B1=B3	B2	F	H	HF	L	R	W	m	
	(mm)									(kg)
XP 04	675	1250	280	1200	1480	2600	150/300/400	650	550	
XP 06	800	1500	280	1500	1780	3100	150/300/400	800	770	
XP 10	875	1650	280	1820	2100	3400	150/300/400	960	1040	

The indicated weights are only intended for informative purposes. The final weight of the assembly is dependent on the unit configuration and is specified in the quotation for a specific unit.

### Connection dimensions

DUCT CONNECTION DIMENSIONS				
	P1	P2	P3	P4
	Large opening	Narrowed opening	Auxiliary chamber	Internal damper
	(mm)			
XP 04	500 × 450	350 × 450	500 × 450	350 × 350
XP 06	650 × 600	350 × 600	650 × 600	450 × 500
XP 10	810 × 660	350 × 760	810 × 760	660 × 450

## Compact version of Air-Handling Units

### Basic components

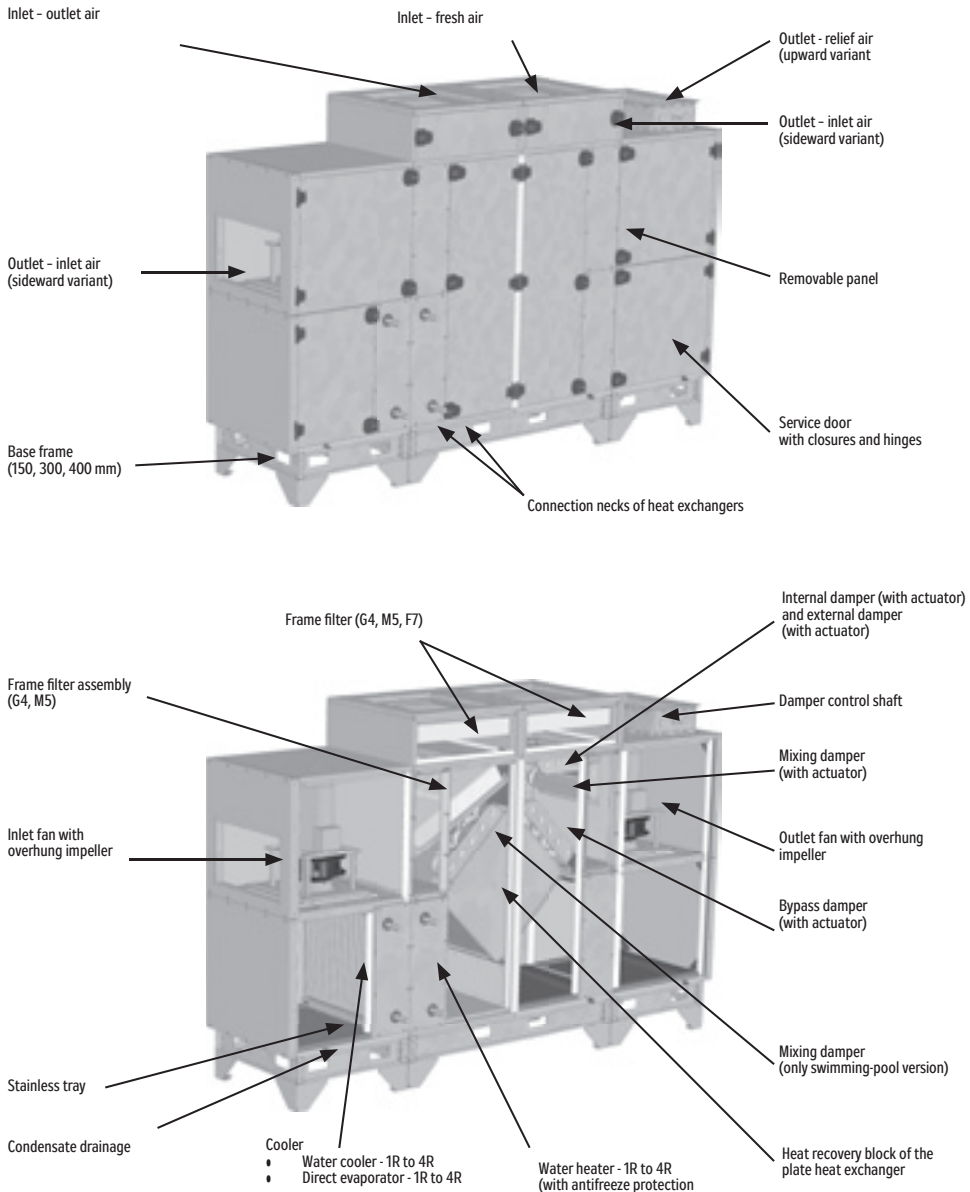

# Air Handling units AeroMaster XP

## Compact version of Air-Handling Units

### Compact unit accessories

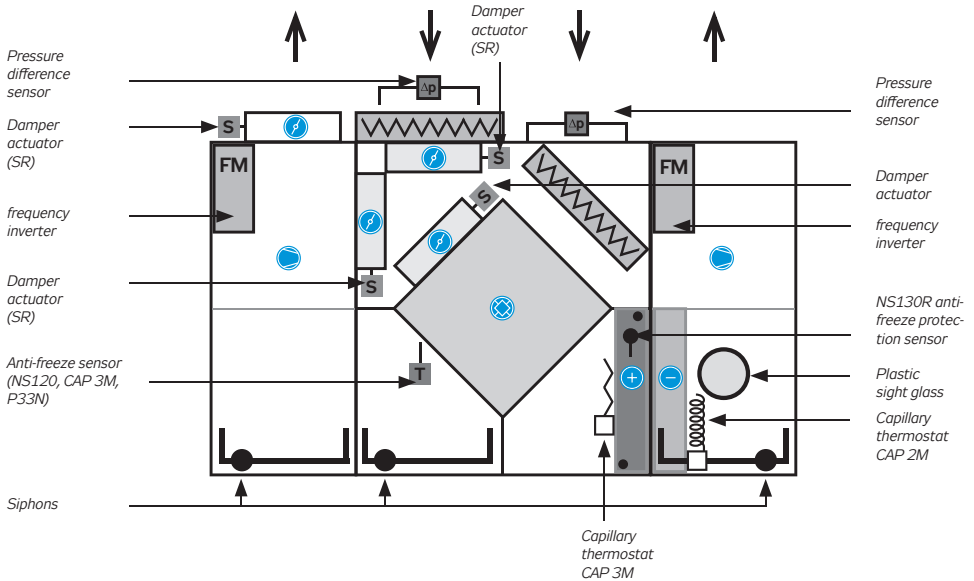

### Delivery to the site

The unit can be dispatched disassembled into individual blocks or assembled on a common frame.

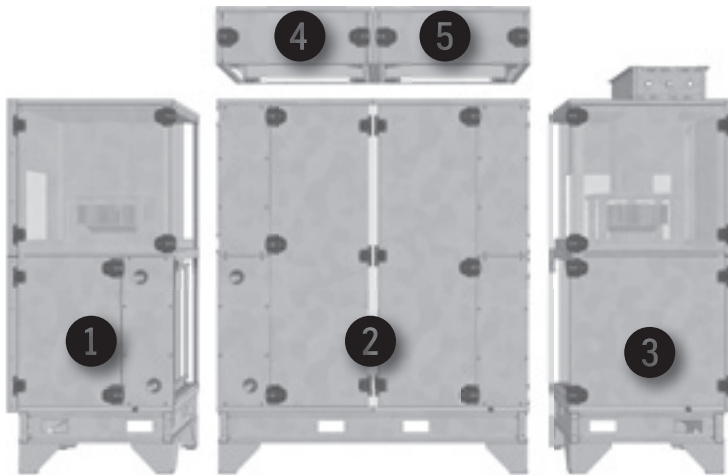

1. Inlet fan block, size XPMK/2
2. XPMK plate exchanger block
3. Outlet fan block, size XPXK/2

4. Auxiliary filter block
5. Auxiliary filter block



## Compact version of Air-Handling Units

### Connection of Blocks

The block connection is performed according to the figure below. When connecting the blocks follow the chapter "Connection of the Unit's Sections" (see page 7, pictures 9 a 10).

**Figure 1** – inner block connection detail

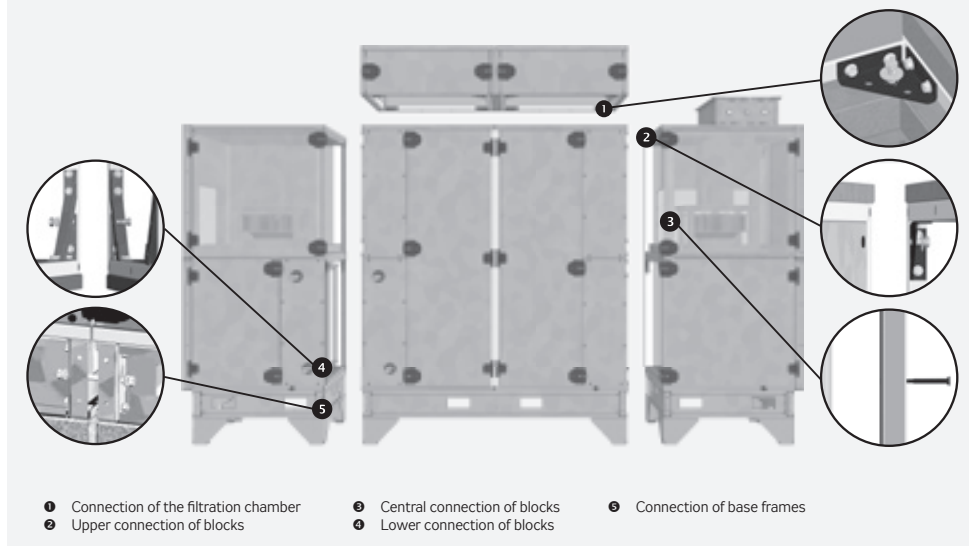

### Filter Replacement

Filter inserts are inserted into the guiding rails. When replacing the filter inserts, make sure they are properly and fully inserted.

**Figure 2** – Replacement of filter inserts

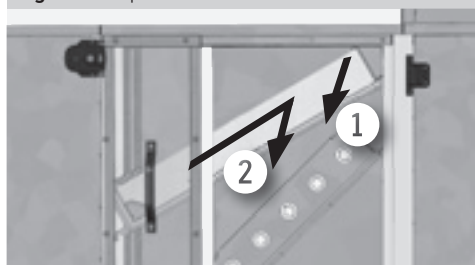

**Figure 3** – Replacement of filter inserts

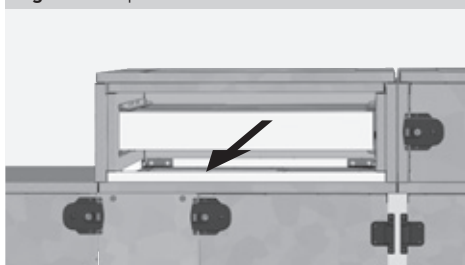

**DIMENSIONS AND NUMBERS OF FILTER INSERTS**

Filter size	Filtration class	Filter dimensions	Numbers of filtration inserts	Kit designation
XP 04	G4, F5	544 x 247 x 98	2	XPNMC 04xx **
XP 04	F7 *	544 x 492 x 98	1	XPNMC 0407
XP 06	G4, F5, F7 *	347 x 642 x 98	2	XPNMC 06xx
XP 10	G4, F5, F7 *	427 x 399 x 98	4	XPNMC 10xx

\* The F7 filtration class filtration insert can only be used for XPHOC internal assembly.

\*\* The required filtration class must be specified after the mark xx

# Air Handling units AeroMaster XP

## Air-handling units modified for clean plants and health service

### Section connection

- The sections can be assembled together by connecting their base frames and connecting the respective sections.
- Before putting together and connecting the sections, it is necessary to paste the rubber sealing (19x4) on the contact surfaces of the connecting frame.
- When connecting two chambers fitted with adjacent condensate drainage trays, it is necessary to paste the rubber sealing (19x4) on the contact surfaces of both trays.
- **For the recommended installation procedure for adjustable or fixed frame feet, refer to a separate section.**
- The chambers must be situated as close as possible during assembly. To pull them together, you can use the base frame connection. Sections without base frames can be pulled together using fastening belts with a ratchet mechanism. The belts must be situated in the lower part as close as possible to the lower panel.
- The base frames are connected using M10x120 screws.
- The chambers are connected together using M6x40 hexagon-head screws inserted into the prepared holes in the connecting frame. The connecting frame is always equipped with tough holes on one side while the holes on the other side are fitted with riveted nuts. All the screws are accessible from inside the unit and there is no need to remove the rear panels. They are sealed with sealant around the entire perimeter from inside the unit.
- **The inner chamber connection is intended to provide final connection. Never use it to pull the chambers together.**
- A conductive interconnection must be ensured using grounding connections when connecting the chambers.
- Unused connecting frame holes must be plugged to prevent undesirable leakage of transported air through them and contamination of the interior of the frame sectional cross members.

Figure 1 – Connection of chambers using the connection frame

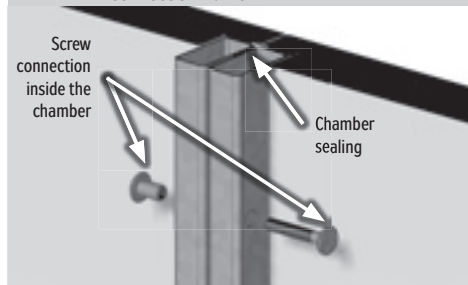

- Once installation has been completed, all the gaps in the connections must be checked and sealed to prevent fouling and dirt deposits building in gaps and to make it easy to clean all the surfaces.
- For sealing, use only sanitary fungicidal (biocidal) sealant. Sealant is a part of the delivery. Sealant must only be applied on a clean surface..

Figure 2 – Sealing at the connection point of the condensate drainage trays

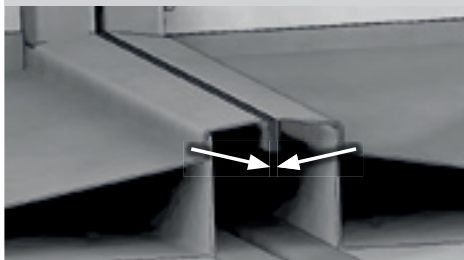
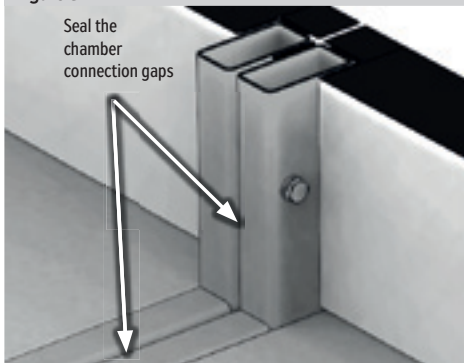

Figure 3



### Filter assemblies, Replacement of filter inserts

- Sliding filter assembly for XP 04, XP 06 and XP10

Figure 4 – Removal of filter insert equipped with a sliding frame (XP04 – XP10)

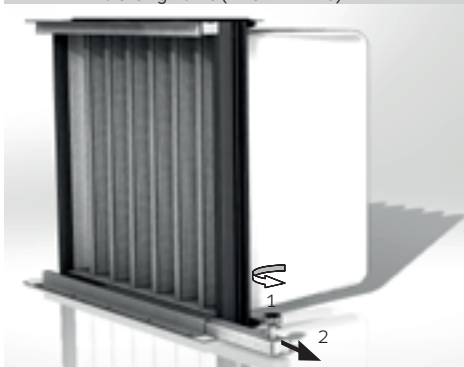

**Fungicidal** – destroys parasitic fungi and mildew

**Biocidal** – includes one or more active substances which destroy, repulse or eliminate harmful organisms; prevents biodegradation by eliminating bacteria, yeasts and fungi

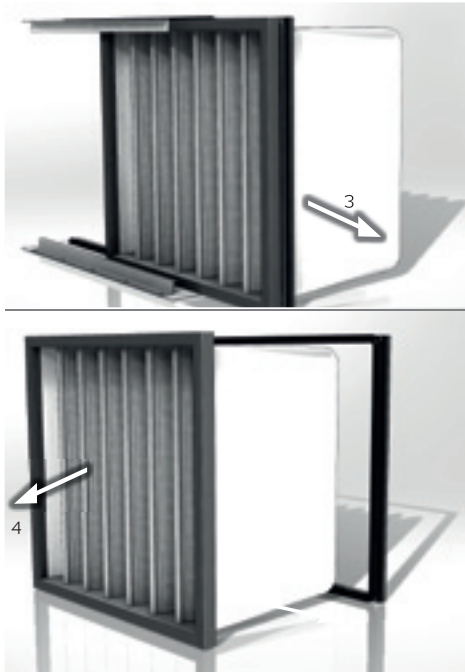

■ Non-sliding filter assembly for XP 04, XP 06 and XP10

Figure 5 – Removal of filter insert equipped with a solid frame (XP04 – XP10)

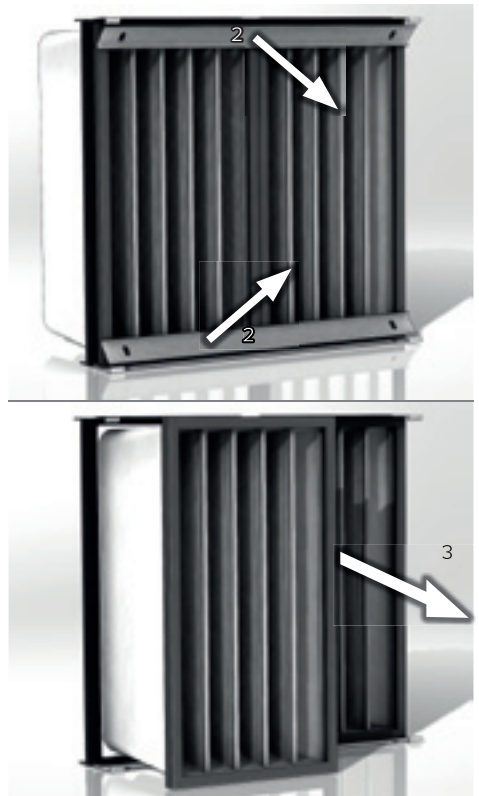

■ Filter assembly for XP 13, XP 17, XP 22 and XP 28

Figure 6 – Filter assembly for XP 13, XP 17, XP 22 and XP 28



XP 13 to XP 28 filter assemblies can be pulled out including the base frame.

# Air Handling units AeroMaster XP

Air-handling units modified for clean plants and health service

## **Warning**

*The manufacturer reserves the right to make changes and amend the documentation due to technical innovations and changes to legislation without prior notice.*

*Printing and language mistakes are reserved.*

*These Installation and Operating Instructions (as a whole or a part) must not be printed or copied without prior written permission from REMAK a. s., Zuberská 2601, Rožnov pod Radhoštěm, Czech Republic.*

*These „Installation and Operating Instructions“ are the sole property of REMAK a. s.*

*The up to date version of this document is available at our website: [www.remak.eu](http://www.remak.eu)  
Changes reserved.*

*Issued: 22nd May, 2018*



**Always observe local laws and regulations.**

# REMAK

REMAK a.s.  
Zuberská 2601, 756 61 Rožnov pod Radhoštěm,  
tel.: +420 571 877 778, fax: +420 571 877 777,  
email: [remak@remak.eu](mailto:remak@remak.eu), internet: [www.remak.eu](http://www.remak.eu)

