



## Air-handling units



## TABLE OF CONTENTS

Basic information.....	2	Heat Recovery.....	32
Construction.....	4	XPXR rotary heat exchanger section.....	32
Outputs and functions.....	6	XPXQ cross heat exchanger.....	33
Unit outputs.....	6	XPTP glycol circuit.....	34
Functions.....	6	Noise attenuation.....	35
Application of units.....	7	XPPO attenuator section.....	35
According to place of installation.....	7	Mixing.....	36
According to material of internal and external casing.....	7	XPID/XPBD mixing section.....	36
Materials.....	8	Accessories.....	37
Specification of material options for the AeroMaster XP design.....	8	XPTP (VO), XPQR (CHV/CHF):	
Materials.....	9	Section with covered feeds.....	37
Installation of unit.....	12	XPUO drop eliminator section.....	37
Assembly.....	12	XPJP empty section.....	38
Position numbers.....	12	XPJD diffuser section.....	38
Installation of unit.....	13	XPRO base frame.....	38
Section interconnection.....	13	XPJS service section.....	39
Unit connections.....	13	XPK closing panel.....	39
Unique variability of supply connection.....	13	VDV elastic connection.....	39
Unit construction.....	14	Measuring & Control.....	40
Interconnection of individual sections.....	14	Comprehensive Solution.....	40
Advantages of multisections.....	15	VCS.....	40
Mutual ordering.....	15	Frequency Inverters.....	41
Fans.....	16	Actuators and Sensors.....	41
XPAP fan section.....	16	Control.....	42
XPAA fan section.....	17	XPRJ control unit section.....	42
XPAA fan section.....	18	XPRF frequency inverter section.....	43
XPZA backup motors.....	19	Examples of units.....	44
Filters.....	20	Examples of arrangements.....	45
Filter groups, properties and typical examples of application.....	20	Unit dimensions.....	47
XPHV filter section.....	21	Outdoor version of units.....	48
XPHO filter section.....	22	characteristics.....	48
XPHT filter section.....	23	Casing mechanical performance.....	48
Filters.....	24	Special sections.....	48
XPHU filter section.....	24	Outdoor unit accessories.....	49
Air heating.....	25	An example of the air-handling unit designed for the outdoor	
XPTV water heating section.....	25	environment.....	49
XPTE electric heating section.....	26	Units for explosive environments.....	50
XPTG gas heating section.....	27	Improved air leakage (L1).....	51
Cooling.....	28	Comprehensive Solution.....	52
Integrated cooling.....	28	Easy-to-get offer.....	53
XPYO cooler section.....	30	Mollier H-X Chart.....	54
Humidification.....	31		
XPJZ steam (isothermal) humidification section.....	31		

## BASIC INFORMATION



THE RIGHT WAY TO COST REDUCTION

### AIR-HANDLING UNITS

Air-handling units AeroMaster XP are intended for comfortable air conditioning both for rooms with normal demands on air exchange as well as for clean rooms. AeroMaster XP units represent the top class in the category of air-flow rate up to 28.000 m<sup>3</sup>/h.



# BASIC INFORMATION

## GOLD MEDAL FOR AEROMASTER XP

The quality of AeroMaster XP units is especially appreciated by our satisfied customers. At the prestigious exhibition Aqua-therm 2002, experts from the field of air-handling systems awarded AeroMaster XP units as the best product in field of air-handling units.

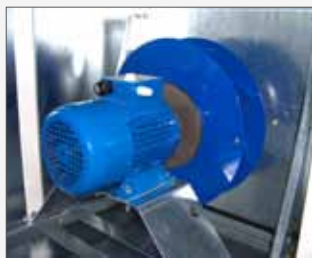

## PLUG FAN WITH FREE IMPELLER

The use of the plug fan with free impeller brings a lot of advantages both with regard to selection and acquisition as well as to the operation of the unit.

- lower fan price
- reduced length of unit
- standard control by frequency converter
- smaller pressure losses
- efficiency of up to 85 % (lower operating costs)
- maintenance-free operation
- (change of belts is not necessary)
- clean operation (saves filters)
- quiet operation



## THERMAL INSULATION

In contrast to comparable units, our units have a casing insulated by rockwool with a density of 110 kg/m<sup>3</sup>, which provides perfect thermal casing insulation (class T3 according to EN1886) and reduced heat losses.



## ECONOMICAL COOLING

The units can be designed with water or direct cooling. The direct evaporators can be designed as single- or two-circuit evaporators depending on the required output.



## HEAT RECOVERY

The up to 85 % efficiency of the heat exchangers guarantees a fast investment return and long-term savings on operation.



## CASCADE CONTROL OF THE ELECTRIC HEATERS

Electric heaters with sequential switching lower the power consumption.



# CONSTRUCTION

AeroMaster XP units are characterized by their original frameless construction. Thanks to this, they achieve top parameters according to the European standard EN 1886.

- CASING MECHANICAL STRENGTH **D2 (M)**
- NETĚSNOST SKŘÍNĚ **L2 (M), (L1(M) OPTIONAL)**
- FILTER BYPASS LEAKAGE **< 0,5% (F9)**
- THERMAL INSULATION **T3**
- THERMAL BRIDGING **TB3**
- OPERATING TEMPERATURE **-40 TO +40°C**
- CASING ACOUSTIC INSULATION (dB/OCTAVE BAND)  
**16,1/125, 19,1/250 Hz, 27,0/500 Hz, 29,7/1 kHz,  
 30,2/2 kHz, 29,3/4 kHz, 33,2/8 kHz**



## ORIGINAL FRAMELESS CONSTRUCTION

The unit is composed of special internal stiffeners and sandwich panels. Their interconnection provides the top parameters. This construction provides key to extraordinary stability and is the key to excellent thermal, fire and acoustic parameters.



## STRONG, WELL-DEIGNED SANDWICH PANELS

The sandwich panel is composed of 50 mm of non-flammable rockwool of a specific mass of 110 kg/m<sup>3</sup> which is inserted between the outside and inside walls made of metal sheets. The width of both walls is 1 mm.



## CLEAN INSIDE SURFACES

The mutual connection of the panels and stiffeners ensures perfectly clean inside surfaces of the unit. Even the standard unit satisfies sanitary standards. The absence of thresholds allows easy cleaning.



## CONSTRUCTION



#### EASY ACCESSABILITY OF ALL SERVICE PLACES

is provided by inspection doors in inspection panels. The closing system enables very easy closing of the inspection door.



#### PREPARED WIRING

All electric devices of the unit have connecting terminals on the casing, which simplifies installation and also reduces installation costs.



#### PRACTICAL ACCESSORIES

The unit can be completed with a series of accessories which enhance operator's comfort.

- Internal connection of sections
- Adjustable legs
- Inspection window
- Condensate drainage sets
- Service door lockable handles
- Internal illumination



#### EASY REMOVAL OF THE BUILT-IN ELEMENTS

Enables their perfect cleaning and is ideal for clean operation: surgical operation rooms, pharmaceutical companies, electro-technical production etc.

# OUTPUTS AND FUNCTIONS

## UNIT OUTPUTS

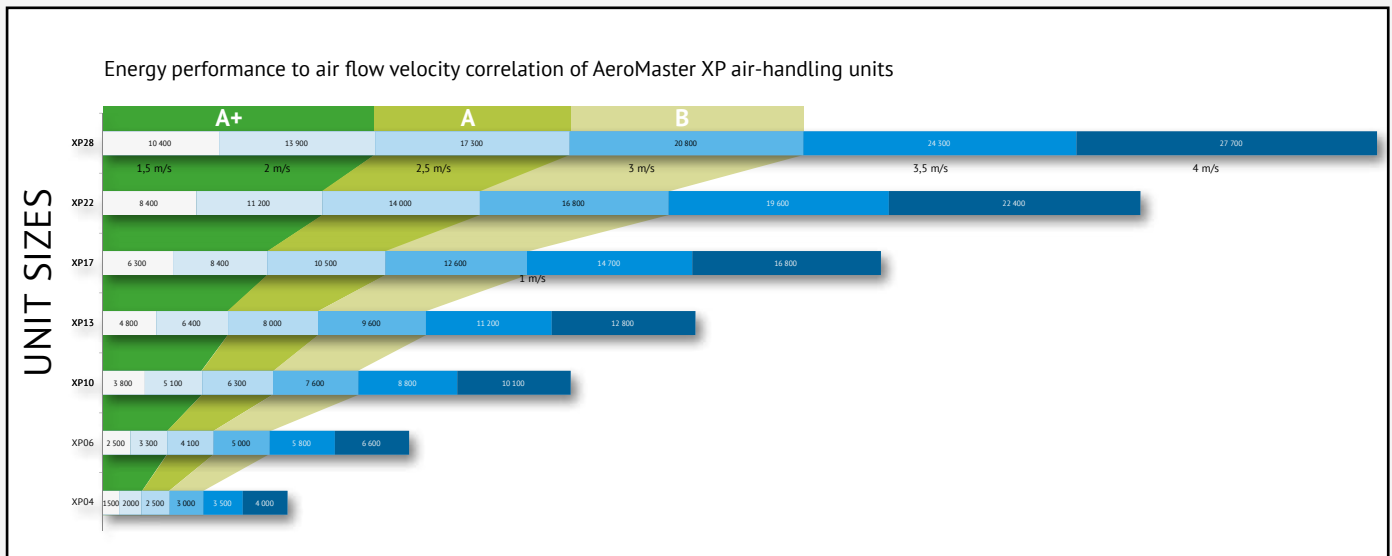

## FUNCTIONS

BASIC FUNCTIONS OF AeroMASTER XP UNITS				
Function		Variant 1	Variant 2	Variant 3
	Fans	with free impeller	in spiral casing	
	Heating	water	electric	gas
	Cooling	direct	water	integrated
	Heat recovery	plate	rotary	glycol circuit
	Humidification	steam	adiabatic	
	Mixing	standard mixing chamber	integrated mixing (in plate heat exchanger section)	
	Filtration	EU3 – EU9 dust	grease	bad smells and harmful substances
	Sound attenuation	splitter noise attenuators		



# APPLICATION OF UNITS

## ACCORDING TO PLACE OF INSTALLATION

The units are intended for indoor and outdoor installation in a normal environment.

### STANDARD DESIGN – INDOOR INSTALLATION

**Basic design**

- Multi-purpose use
- Economy
- Top parameters



### STANDARD VERSION COMPLYING WITH HYGIENE REQUIREMENTS

**Can be used in clean applications**

Suitably combining internal casing materials, air-handling unit arrangement and its parameters, an XP air-handling unit complying with hygiene requirements can be designed. These air-handling units can be used in clean applications.

- Perfectly clean surfaces
- Easy to remove and clean drop eliminators
- Stainless condensate drain kits
- Sanitary certificate
- Leakproof



### STANDARD VERSION WITH ACCESSORIES – OUTDOOR INSTALLATION

Suitably combining the external and internal casing materials, air-handling unit arrangement and outdoor accessories (e.g. roof, etc.), a version of the XP air-handling unit for outdoor applications can be designed.

- Anticorrosive surface RAL9002
- Protecting roof
- External louvres
- Special bonding
- Inside-placed dampers
- Protection of base frame
- Covered inlets



## ACCORDING TO MATERIAL OF INTERNAL AND EXTERNAL CASING

The external and internal casing can be provided in different material combinations.



# MATERIALS

## SPECIFICATION OF MATERIAL OPTIONS FOR THE AEROMASTER XP DESIGN

See Component General Property Options in the AeroCAD design software: (example of the fan section)

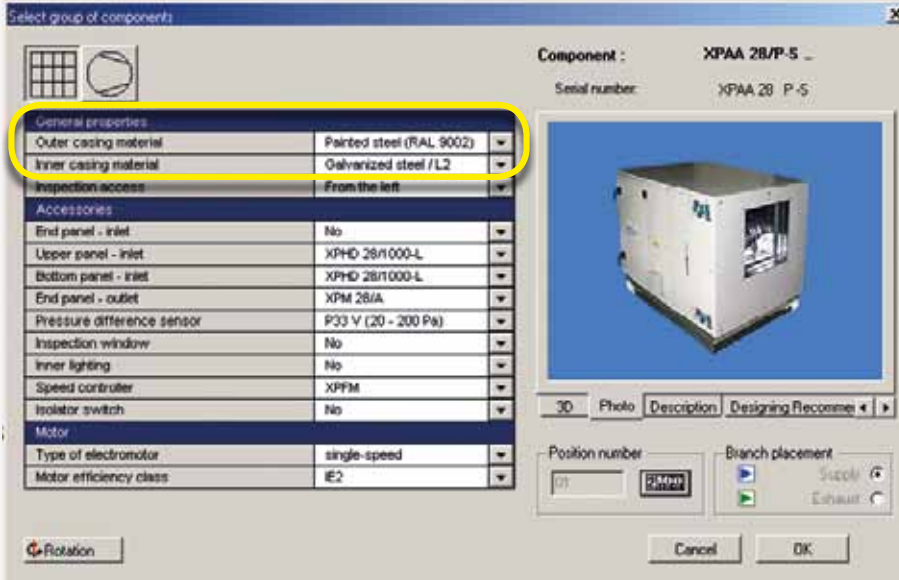

### 1. EXTERNAL CASING MATERIALS

Sheet type used for external walls of the panels:

- galvanized sheet steel; continuous hot-dip galvanized EN 10 346 Z275 g/m<sup>2</sup>, corrosion resistance for C2 environment class as per EN ISO 14713
- galvanized sheet steel - continuous hot-dip galvanized EN 10 346 Z275 g/m<sup>2</sup> + 25 µm polyester paint, RAL 9002 EN10169 (corrosion resistance RC3), corrosion resistance for C3 environment class as per EN ISO 14713

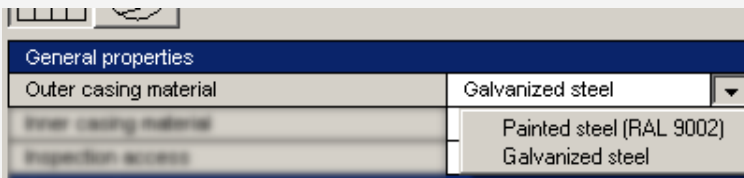

### 2. INTERNAL CASING MATERIALS (SECTION)/TIGHTNESS

Sheet type used for internal walls of the panels:

- galvanized sheet steel; continuous hot-dip galvanized EN 10 346 Z275 g/m<sup>2</sup>, corrosion resistance for C2 environment class as per EN ISO 14713
- stainless sheet steel AISI 304; X5CrNi18-10 ISO for hygienic (and gastronomic) applications
- air-handling unit air leakage class specification in accordance with EN 1886 (L2 or L1)

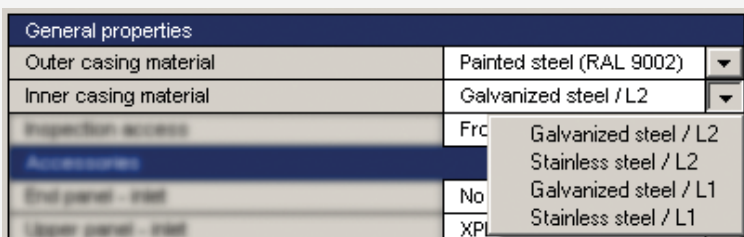

Higher corrosion resistance class materials must be used for casings exposed to the aggressive influence of the environment or transported air, especially for classes C4/C5 as per EN ISO 14713 (on demand, please see below).

**FOR A HIGHER CORROSION RESISTANCE DESIGN OF THE CASING**

an offer must be obtained from the manufacturer/distributor – including specification of the required design. Possible deliveries:

**External casing:**

- powder painted sheet steel – continuous hot-dip galvanizing EN 10 346 Z275 g/m<sup>2</sup> + 60 µm paint (outer side), RAL 9002, corrosion resistance for C4 environment class as per EN ISO 14713

**Internal casing:**

- powder painted sheet steel – continuous hot-dip galvanizing EN 10 346 Z275 g/m<sup>2</sup> + 60 µm paint (outer side), RAL 9002, corrosion resistance for C4 environment class as per EN ISO 14713
- stainless sheet steel AISI 316L; X2CrNiMo17-12-2 ISO for coastal areas and transported air containing chlorine (pool applications).

**INTERNAL CASING MATERIALS (OTHER PARTS)**

COMPONENT	PART	STANDARD VERSION *	STAINLESS VERSION **
Internal casing parts (connecting and supporting elements)	Vertical cross-members – profiles	50x25x2 EN 10 219-2, hot-dip galvanized EN 10 346 Z275 g/m <sup>2</sup> + 60 µm powder coat, RAL 9002	
	Horizontal cross-members	hot-dip galvanized sheet steel EN 10 346 Z275 g/m <sup>2</sup>	stainless sheet steel AISI 304; X5CrNi18-10 ISO for hygienic (gastronomic) applications
	Profiles of the connecting frame	25 × 25 × 2 EN 10 219-2 hot-dip galvanized EN 10 346 Z275 g/m <sup>2</sup> + powder coating 60 µm, RAL 9002	
	Connecting frame corner-irons	hot-dip galvanized sheet steel EN 10 346 Z275 g/m <sup>2</sup>	hot-dip galvanized sheet steel EN 10 346 Z275 g/m <sup>2</sup> + powder coating 60 µm, RAL 9002
	Cross-member attaching angle-irons	hot-dip galvanized sheet steel EN 10 346 Z275 g/m <sup>2</sup>	hot-dip galvanized sheet steel EN 10 346 Z275 g/m <sup>2</sup> + powder coating 60 µm, RAL 9002
	Connecting material	galvanized steel	stainless steel

\* Corrosion resistance for C2 environment class as per EN ISO 14713

\*\* Hygienic applications

**3. UNIT ASSEMBLIES AND INTERNAL PARTS (EXCEPT SECTION CASING)**

In all the above-mentioned design alternatives of casing walls, the assemblies are of the same design – standard, i.e. galvanized steel. **This applies regardless of the assembly code!**

SECTION/COMPONENT/PART	STANDARD VERSION *	
<b>Belt driven fan section</b>	Fan-casing	galvanized sheet steel
	RHD fan - impeller	painted steel, RAL 7030
	ADH fan - impeller	galvanized steel
	Fan-shaft	steel – protective paint
	Motor-casing	painted, RAL 5010 (7030)
	Motor-shaft	steel – protective paint
	Pulley	cast iron (hub – steel)
	Stretching side rails	galvanized steel
	Belt cover	galvanized sheet steel
	Parts of assembly, sheet	galvanized sheet steel
	Vibration absorbers	rubber/galvanized steel

\* Sheet steel finish: hot-dip galvanized EN 10 346 Z275 g/m<sup>2</sup>, corrosion resistance for C2 environment class as per EN ISO 14713

# MATERIALS

## 3. UNIT ASSEMBLIES AND INTERNAL PARTS (EXCEPT SECTION CASING) – CONTINUED

SECTION/COMPONENT/PART		STANDARD VERSION*
Fan section with free impeller	Fan – impeller	painted steel, RAL 2002 (hub – steel)
	Motor – casing	painted, RAL 5010 (7030)
	Motor – shaft	steel – protective paint
	Fan cover	galvanized sheet steel
	Parts of assembly, sheet	galvanized sheet steel
	Vibration absorbers	rubber/galvanized steel
Diffuser assembly	Parts of assembly, sheet	galvanized sheet steel
Dividing panel	Parts of assembly, sheet	galvanized sheet steel
Plate heat exchanger	Heat exchanger insert	Al fins, frame - galvanized sheet
	Parts of assembly, sheet	galvanized sheet steel
Rotary heat exchanger	Heat exchanger rotor	aluminium (Al) foil
	Flushing chamber	galvanized sheet steel
	Heat exchanger frame	galvanized sheet steel
	Internal casing (panels)	galvanized sheet steel
	Motor mounting	galvanized sheet steel
	Motor – casing	painted, RAL 5010 (7030)
	Motor – shaft	steel – protective paint
VO, CHV, CHF exchangers	VO/CHV headers	painted steel
	CHF headers	copper
	Casing	galvanized sheet steel
	Fins	aluminium (Al) foil
	Tubes	copper
Drop eliminator	Casing	stainless sheet steel, material 17 241
	Fins	plastics – polypropylene PPTV +80 °C
Electric heater	Casing	galvanized sheet steel
	Heating rods	stainless steel
	Wiring	plastics, copper, aluminium, brass
Bag filter section	Filter insert frame	plastics (galvanized sheet steel)
	Filtration material	synthetic fibre
	Section components	galvanized sheet steel
Grease filter section	Filter Insert	aluminium (ALU)
	Filter tray	stainless sheet steel
	Section components	galvanized sheet steel
Insert air filter section	Filter insert frame	galvanized sheet steel - aluminium (ALU) tubes
	Filtration material	synthetic fibre
	Section components	galvanized sheet steel
Filter section – active carbon	Filter frame	galvanized sheet steel
	Cartridges	anodized sheet
	Section components	galvanized sheet steel
Filter section – compact filter	Filter Insert	plastic
	Section components	galvanized sheet steel
Splitter attenuator	Splitter frame	galvanized sheet steel
	Filler	mineral wool
	Cover textile	unwoven glass fibre

\* Sheet steel finish: hot-dip galvanized EN 10 346 Z275 g/m<sup>2</sup>, corrosion resistance for C2 environment class as per EN ISO 14713

**For other assembly designs** an offer must be obtained from the manufacturer/distributor – including specification of the required design. Based on this specification, the assembly materials will be designed as in the following examples:

#### Exchangers (VO, CHV, CHF)

- Fins coated with epoxy layer
- Painted or stainless steel frame
- Copper headers (VO, CHV)
- Mounting bars (parts made of sheet steel), stainless sheet steel or galvanized steel – 60 µm powder coating

#### Heat exchangers

- Plate heat exchanger fins and rotary heat exchanger rotor coated with epoxy paint
- Painted or stainless steel frame

#### Drop eliminator

- Stainless steel AISI 304; X5CrNi18-10 ISO or AISI 316L; X2CrNiMo17-12-2 ISO

#### Electric heater

- Painted or stainless steel heater frame (stainless steel rods as standard)
- Mounting bars (parts made of sheet steel), stainless sheet steel or galvanized steel – 60 µm powder coating

#### Filter Assemblies

- Frames (parts made of sheet steel), stainless sheet steel or galvanized steel – 60 µm powder coating

#### Splitter attenuator

- Painted or stainless steel splitter frame

#### Fan Assemblies

- Fan impeller, in accordance with the supplier's technical possibilities
- Motor, complying with the specification requirements
- Assembly parts, stainless sheet steel or galvanized steel – 60 µm powder coating

When stainless steel parts are required, stainless steel AISI 304; X5CrNi18-10 ISO or AISI 316L; X2CrNiMo17-12-2 ISO will be used taking into account the unit application. More detailed specifications of parts will be a part of the design of the respective assembly type, including the accessories.

#### 4. AIR-HANDLING UNIT'S SEPARATE ACCESSORIES

SECTION/COMPONENT/PART	MATERIAL
Base frame (XPRO)	galvanized sheet steel; continuous hot-dip galvanized EN 10 346 Z275 g/m2

Corrosion resistance for C2 environment class as per EN ISO 14713

SECTION/COMPONENT/PART	MATERIAL *	
Blade dampers/by-pass	Casing	galvanized sheet steel
	Flanges	galvanized sectional steel
	Fins	sectional aluminium (ALU)
	Sealing	rubber EPDM
	Gear wheels	plastics PA6 + fibre glass
	Shaft-square	galvanized steel
Flexible connection	Flanges	galvanized sectional steel
	Casing	galvanized sheet steel + polyester/ PVC +80 °C

\* Sheet steel finish: hot-dip galvanized EN 10 346 Z275 g/m2, corrosion resistance for C2 environment class as per EN ISO 14713

**For other designs**, an offer must be obtained from the manufacturer/distributor – including specification of the required design. Examples:

#### Blade Dampers

- Casing + stainless flanges
- Casing + aluminium fins
- Casing + aluminium fins of higher corrosion resistance

#### Flexible connection

- Casing + stainless flanges

*Note:*

*For additional accessories for outdoor versions, refer to the given section of this catalogue.*

# INSTALLATION OF UNIT

## ASSEMBLY



Complex delivery incl. all binding components.

## THE ASSEMBLING OF THE UNIT HAS TO BE DONE ACCORDING TO THE POSITION NUMBERS

These numbers are stated in the documentation, which is a part of delivery and on the label of every section.

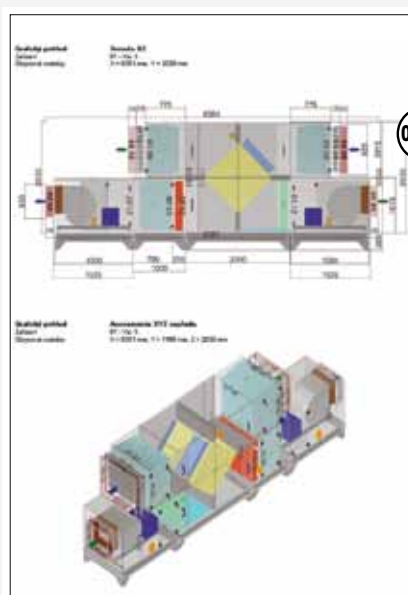

04.25

04.25

04.25



REMAK <sup>®</sup> PGF MF 01 CE	
REMAK a.s., Záborská 2001, CZ-756 61 Rokytno pod Radhoštěm, <a href="http://www.remak.cz">http://www.remak.cz</a>	
Objednací číslo	PO000080/0000933/14
Název zakázky	mat., krmaty_PV-7_XP13-WBC
Pracovní číslo	04.25
Datum výroby	31.01.12
<b>Výrobní část</b>	<b>AeroMaster XP</b>
Seřazení ohřívadla	XPTP 13IS
Výrobní kód	XPTPB13
Objem	1 86000
Hmotnost (+/-10%)	150 kg
<b>Prívěs</b>	<b>7935</b>
Nominální průtok vzduchu	XP1
<b>Vodní ohřívadla</b>	<b>XP</b>
Výrobní kód	XP
Tlaková ztráta	122
Teplosná médium	40 l
(Am)	
Vstupní teplota média	80 °C
Výstupní teplota média (zadaná)	60 °C
Výstupní teplota média (skutečná)	84 °C
• Vstupní parametry vzduchu	
Zima = Léto	
Teplota	1,8 °C = 30,1 °C
Relativní vlhkost	12 % = 45 %
• Výstupní parametry vzduchu	
Zima = Léto	
Teplota	45,0 °C = 30,1 °C
Relativní vlhkost	1,5 % = 40 %
Topný výkon (skutečný)	113,6 kW
Průtok teplosnáho média	6,66 m <sup>3</sup> /h
Tlaková ztráta média	4,3 kPa
Počet řad	4
Počet okruhů	1
Rozměr lamel	2,1 mm
Materiál lamel	Cu
Materiál trubek	Al
Průměr připojení	1 1/2"
Vodní obsah	14 l
<b>Směšovací uzel</b>	<b>SUMX 16 (3)</b>
Výrobní kód	VSL02468
<b>Protimrazové čidlo</b>	<b>NS 150 R</b>
Výrobní kód	XPNS150R
<b>Doplňková protimrazová ochrana</b>	<b>CAP 3M</b>
Výrobní kód	XPNSCAP3
REMAK, Vento, AeroMaster, DoorMaster, AeroCAD, WebClima jsou registrované ochranné známky společnosti REMAK a.s.	

04.25  
31.01



# INSTALLATION OF UNIT

## SECTION INTERCONNECTION



■ base frame connection



■ section interconnection

Threaded joints ensure a firm assembly.

The installation of the unit, which is composed of 3 transport sections, can be done in 30 minutes.

## UNIT CONNECTIONS



■ duct connection

The unit is connected by means of elastic connections, which limits vibration transfer.

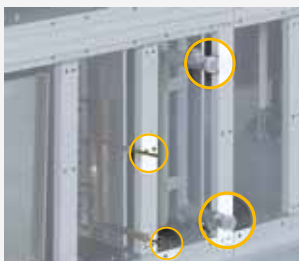

■ supply connection

During installation, all supply media are connected on the outside. The inside interconnection is done during manufacture. The appropriate connection points are marked by labels.

## UNIQUE VARIABILITY OF SUPPLY CONNECTION

The AeroMaster XP unit construction structure enables you to combine the sides of the supply connection and the service accesses. This option gives a designer a chance to optimally use the space of the machine room and current mains. The connection side is determined according to the air-flow direction.

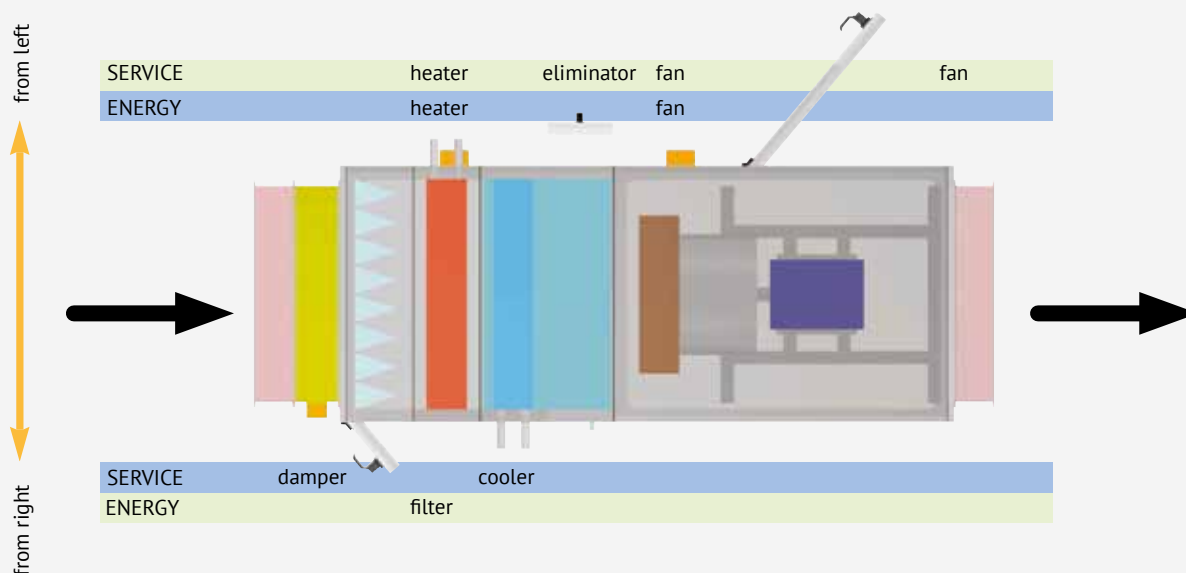

# UNIT CONSTRUCTION

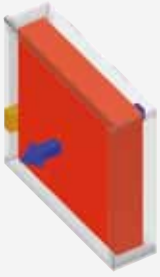

**SECTION**  
This is a basic building part of AeroMaster XP units. It's a compact part which can be separately transported and which is intended for the installation of built-in elements.

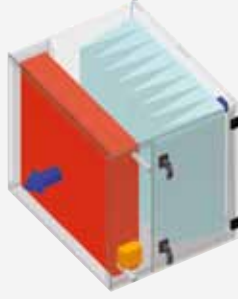

**MULTISECTION**  
The multi-functional block is the optimized merge of several sections into one.



## INTERCONNECTION OF INDIVIDUAL SECTIONS

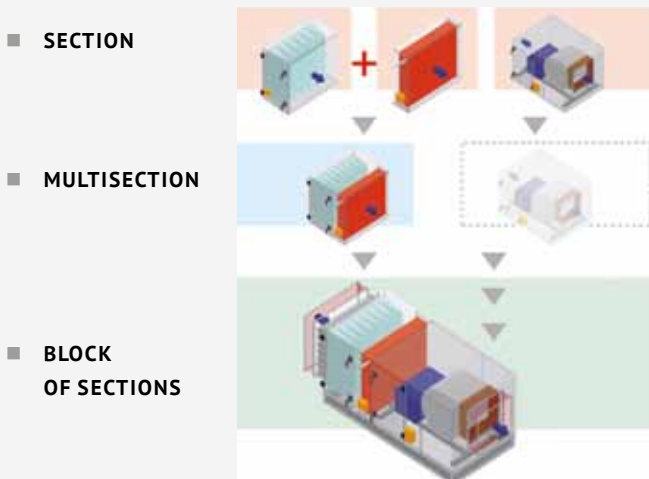

## BLOCKS OF SECTIONS

The sections can be merged together on a common frame up to a length of 3000 mm.

# UNIT CONSTRUCTION

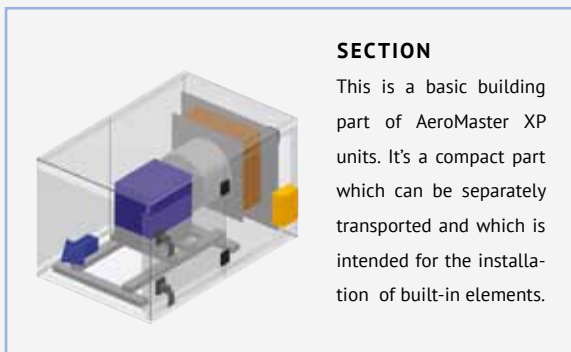

**SECTION**  
 This is a basic building part of AeroMaster XP units. It's a compact part which can be separately transported and which is intended for the installation of built-in elements.



**SECTION DIMENSIONS**  
 All sections are created by multiples of the basic module of 250 mm in length. This modular concept enables the unit length optimization.

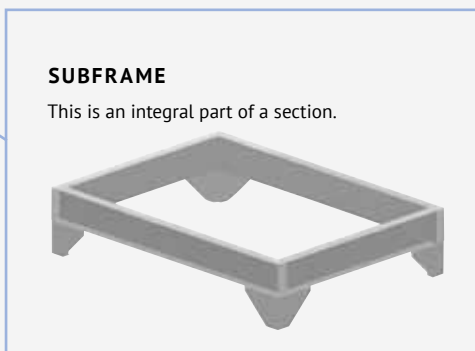

**SUBFRAME**  
 This is an integral part of a section.

## ADVANTAGES OF MULTISECTIONS

- lower price
- simpler installation

## MUTUAL ORDERING

The air-handling units AeroMaster XP can be optionally selected so that they suit the conditions provided by the place of installation. The supply and exhaust parts of the standard type can be put together in the following variations: in series, parallel, vertical. Special solutions can be realized after reaching an agreement with the REMAK headquarters.

■ **SUPPLY AND EXHAUST, IN SERIES**

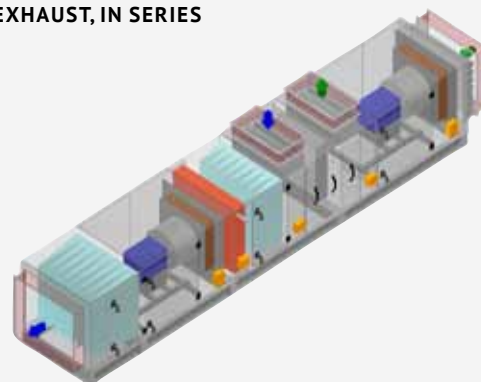

■ **SUPPLY AND EXHAUST, VERTICAL**

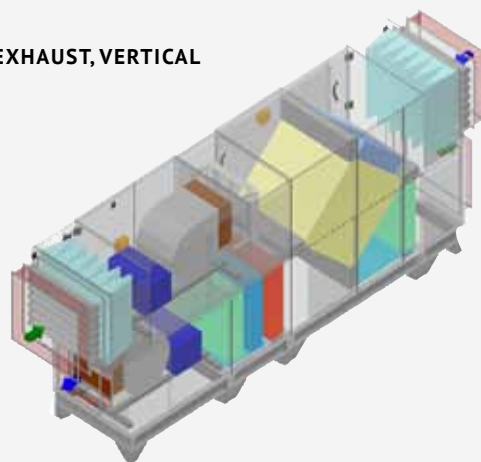

■ **SUPPLY AND EXHAUST, PARALLEL**





## XPAP FAN SECTION

### XPVP SECTION

#### CHARACTERISTICS

Plug-fan with free impeller.

#### PARAMETERS

Electric voltage:

- 3 × 400 V / 50 Hz

Power supply:

- up to 3 kW 230 VD / 400 VY
- over 3 kW 400 VD / 690 VY

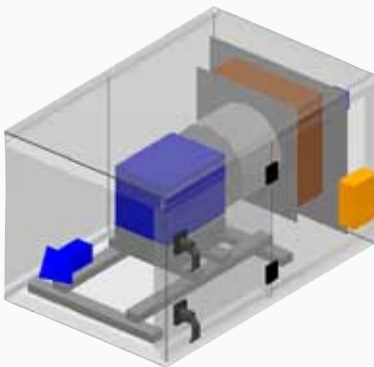
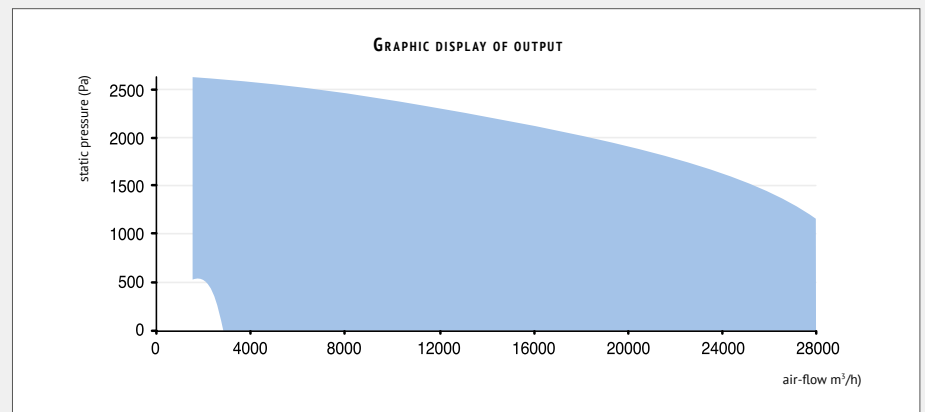

#### CONSTRUCTION AND DESIGN

Impeller:

- Free impeller with backward curved blades made of metal sheets with coloured coating. On the inlet side, there is a metal diffuser.

Motor:

- Single-speed asynchronous motors with short-circuit armature.

Transmission and gripping:

- Impeller is placed on spindle of electromotor.
- Motor is fixed to the subframe, which is connected to the casing by silent-blocks which absorb vibrations.

#### CONTROL AND PROTECTION

Protective elements:

- The motors are normally equipped with thermocontacts built into the winding.

Regulace:

- The motors can be controlled by frequency inverters.

## XPAA FAN SECTION

### XPVA SECTION

#### CHARACTERISTICS

Double inlet with forward curved blades.

#### PARAMETERS

Electric voltage:

- 3 × 400 V / 50 Hz

Power supply:

- up to 3 kW 230 VD / 400 VY
- over 3 kW 400 VD / 690 VY

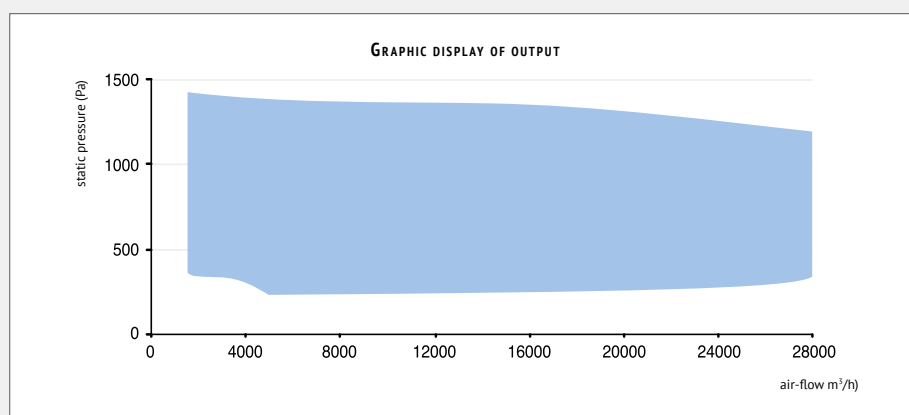

#### CONSTRUCTION AND DESIGN

Impeller:

- Single-speed or double-speed asynchronous motors with short-circuit armature.
- The fan impeller and spiral casing are made of galvanized sheet steel

Motor:

- Single-speed or double-speed asynchronous motors with short-circuit armature.

Transmission and gripping:

- Transmission is provided by v-belts. Pulleys are fixed by TAPER-LOCK hubs.

#### CONTROL AND PROTECTION

Protective elements:

- Motors are normally equipped with thermocontacts built into the winding.

Control:

- The output can be controlled by switching the motor winding or by frequency inverters.

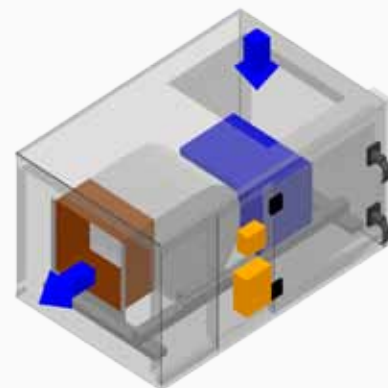



## XPAA FAN SECTION

### XPVR SECTION

#### CHARACTERISTICS

Double inlet with backward curved blades.

#### PARAMETERS

Electric voltage:

- 3x 400 V / 50 Hz

Power supply:

- up to 3 kW 230 VD / 400 VY
- over 3 kW 400 VD / 690 VY

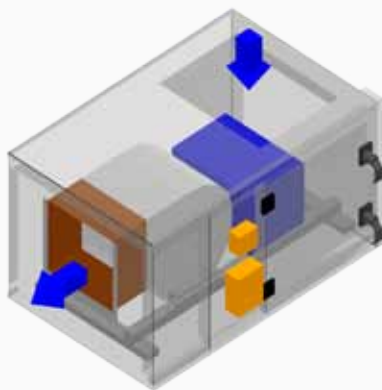
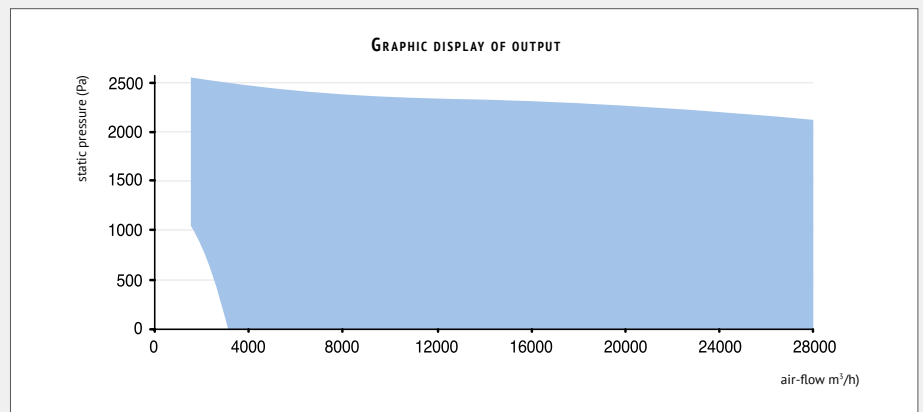

#### CONSTRUCTION AND DESIGN

Impeller:

- With forward curved blades with coloured coating. Fan casing is fixed in silent-blocks.

Motor:

- Single-speed or double-speed asynchronous motors with short-circuit armature

Transmission and gripping:

- Transmission is provided by v-belts. Pulleys are fixed by TAPER-LOCK® hubs.

#### CONTROL AND PROTECTION

Protective elements:

- Motors are normally equipped with thermocontacts built into the winding.

Control:

- The output can be controlled by switching the motor winding or by frequency inverters.



## XPZA BACKUP MOTORS

### CHARACTERISTICS

The fan section, respectively a built-in fan assembly, with a backup motor (drive) for the „backup“ function is equipped with two motors situated in one fan section; each motor belt drive leads to the common shaft of the fan.

The backup function is designed so that the main motor runs in basic mode while the second/backup motor will only run if the main motor fails.

The backup is ensured by automatic start-up of the backup motor if the main fan motor has failed.



### CONSTRUCTION AND DESIGN

- The backup fan section is always equipped with two dP air flow sensors.
- One sensor is assigned to the main fan motor while the other is for the backup fan motor.
- Information on a main motor failure from the assigned sensor is sent, as a warning signal, to the control unit terminals. This failure is not signalled in the control unit.
- As soon as the main motor failure has been registered, the backup motor is automatically started.
- In case of such a backup, the air-handling unit will be switched to STOP mode, which will be signalled acoustically as well as visually by the control unit in the standard way, respectively using optional external outputs of failure signalling (other than those used for the backup mode signalling).

### RECOMMENDATIONS:

- We recommend using the control systems (REMAK) for sections equipped with back-up motors.

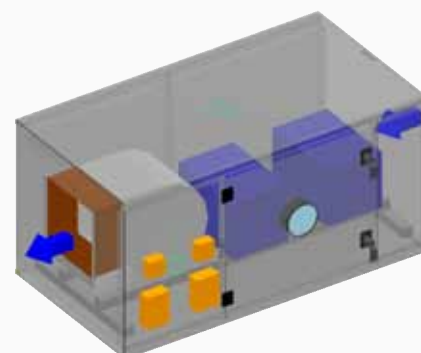

## FILTER GROUPS, PROPERTIES AND TYPICAL EXAMPLES OF APPLICATION

FILTRATION CLASS	PROPERTIES AND RECOMMENDED USE	MEAN RATE OF SYNTHETIC DUST SEPARATION AS PER EN 779* (%)
<b>G – COARSE DUST FILTERS</b>		<b>EFFECTIVE FOR PARTICLES &gt; 10 µm</b>
G1** G2**	<ul style="list-style-type: none"> <li>■ only for simple applications</li> <li>■ effective for coarse and fibrous particles</li> <li>■ application examples: protection against insects, capture of sand, coarse fly ash, water drops, textile fibres, hair and fuzz, leaves, etc.</li> <li>■ pre-filters for higher dust concentrations</li> </ul>	G1: Am < 65 G2: 65 < Am < 80
G3 G4	<ul style="list-style-type: none"> <li>■ protection of air-handling devices against contamination; heat exchangers, humidifiers and fans</li> <li>■ effective against dust, fly ash and pollen</li> <li>■ filtration in applications for garages, department stores and sports halls; filtration of discharged air from paint spray booths or kitchens</li> <li>■ pre-filters for F7 and F8 filtration classes (necessary only for heavily contaminated inlet air) and circulating air filters</li> </ul>	G3: 80 < Am < 90 G4: 90 < Am  <i>Note: Am – mean rate of synthetic dust separation (%)</i>
<b>M – MEDIUM DUST FILTERS</b>		<b>EFFECTIVE FOR PARTICLES &gt; 1 µm</b>
M5 M6	<ul style="list-style-type: none"> <li>■ outdoor air filters for less demanding rooms (e.g. workshops, sales and storage premises, garages, meeting rooms, sports halls, restaurants)</li> <li>■ in industry, for plants requiring higher level of cleanliness (chemical and paper industry, less demanding precision engineering plants, etc.)</li> <li>■ effective for air-borne dust particles PM10 (aerosol particles below 10 µm)</li> <li>■ partially effective against spores and larger bacteria</li> <li>■ poorly effective against soot, oil mist and tobacco smoke and smoke emissions from technological processes</li> <li>■ pre-filters (F5) for F8 and F9 filtration classes; pre-filters (F6) for F9 and H10 filtration classes</li> </ul>	M5: 40 < Em < 60 M6: 60 < Em < 80
<b>F – FINE DUST FILTERS</b>		<b>EFFECTIVE FOR PARTICLES &gt; 1 µm</b>
F7	<ul style="list-style-type: none"> <li>■ after-filters in middle level demanding air-handling systems, e.g. department stores a groceries, offices, wards, theatres, kitchens, specific production facilities and laboratories</li> <li>■ in industry, for telephone exchanges, food production, precise engineering and optics workshops, TV and broadcast studios, air inlet to paint spray booths</li> <li>■ effective against bacteria and spores, cement dust, through lungs dust, dust particles PM2.5</li> <li>■ partially effective against soot, oil mist and tobacco smoke and smoke emissions from technological processes</li> <li>■ pre-filters for H11 and H12 filtration classes</li> <li>■ pre-filters for absorption filters (e.g. active carbon filters)</li> </ul>	F7: 80 < Em < 90
F8 F9	<ul style="list-style-type: none"> <li>■ after-filters (2nd filtration stage) in more demanding air-handling systems, e.g. offices, switch rooms, laboratories, computer rooms</li> <li>■ air-inlet systems in hospitals, operating theatres, auxiliary rooms of sterilizing stations and operating theatres, testing laboratories, chemical and pharmaceutical production plants</li> <li>■ very effective against soot, oil mist and tobacco smoke (coarse fractions) and smoke emissions from technological processes (coarse fractions) and bacteria</li> <li>■ pre-filters for H13 and H14 filtration classes</li> <li>■ pre-filters for absorption filters (e.g. active carbon filters)</li> <li>■ pre-filters for pharmaceutical industry (certification regulations must be observed)</li> </ul>	F8: 90 < Em < 95 F9: 95 < Em  <i>Note: Em – mean rate of atmospheric dust separation for particles 0,4 µm (%)</i>

\* For valid CZ issue of ČSN EN 779:2012, for EU EN 779:2011, \*\* G1 and G2 are not included in the REMAK offer.

## XPHV FILTER SECTION

### WOVEN FILTER INSERT

#### CHARACTERISTICS

These are designed to protect an air-handling device against contamination and coarse dust. They are used for single-stage air filtration in simpler air-handling systems or as pre-filters before filters of higher filtration class, and thus they help to extend their service life and reduce operating costs.

#### PARAMETERS

- Filtration class: G3
- Recommended final pressure loss of the filter (EN 13053:2006E): 150 Pa
- Final pressure loss of the filter specified by the manufacturer: 300 Pa
- Max. thermal resistance: 100 °C

#### CONSTRUCTION AND DESIGN

- The filter insert is made of an unwoven, 100 % polyester, thermally and mechanically strengthened textile which is stretched between aluminium braces of the metal frame.
- The frame filter is made of pleated filtration medium fitted into a reinforced cardboard frame.
- The insert is pushed into the guiding frame and locked by a mechanical ratch. Access to the insert is provided by the inspection door.

#### RECOMMENDATIONS

- If there is a reduced cross-section before the filter section, we recommend adding an empty section to improve the effective filtration area.

#### REMARK:

- The filtration insert can not be regenerated.

### FRAME FILTER

#### CHARACTERISTICS

These are designed to protect an air-handling device against contamination and coarse dust. They are used for single-stage air filtration in simpler air-handling systems or as pre-filters before filters of a higher filtration class, and thus they help to extend their service life and reduce operating costs. It is suitable for protection of air-conditioning devices equipped with heat recovery exchangers.

#### PARAMETERS

- Filtration class: G4
- Recommended final pressure loss of the filter (EN 13053:2006E): 150 Pa
- Final pressure loss of the filter specified by the manufacturer: 300 Pa
- Max. thermal resistance: 70 °C

#### CONSTRUCTION AND DESIGN

- The frame filter is made of pleated filtration medium fitted into a reinforced cardboard frame.
- The insert is pushed into a guiding frame. Access to the insert is provided by the inspection door.
- On request, the filter can be delivered in a plastic frame or in the M5 filtration class version.

#### RECOMMENDATIONS

- If there is a reduced cross-section before the filter section, we recommend adding an empty section to improve the effective filtration area.

#### REMARK:

- The filtration insert can not be regenerated.

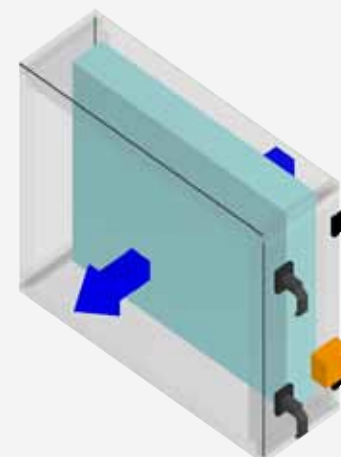
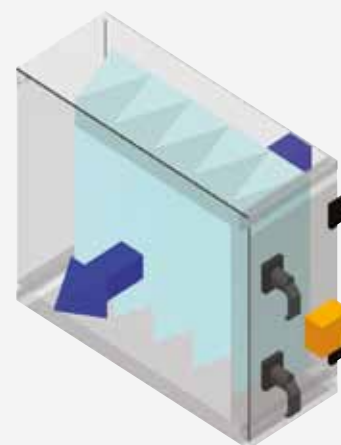

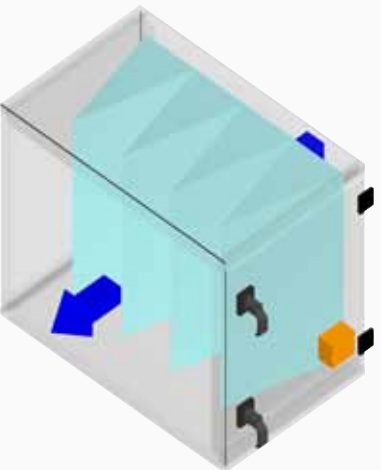
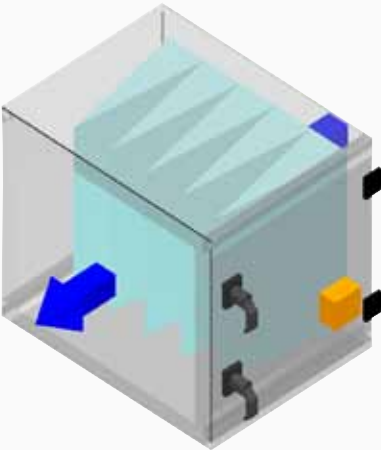

## XPHO FILTER SECTION

### BAG FILTER

#### CHARACTERISTICS

Intended for the 1. & 3. filtration stages in dependence on the class of filtration fabric used.

The bag filtration inserts are made of unwoven polyester textile with high absorption capacity fitted into a plastic frame.

#### PARAMETERS

Filtration class:

■ G3–F9

Final pressure loss of the filter specified by the manufacturer:

■ G3–G4 250 Pa

■ F5 (M5), F6 (M6) 400 Pa

■ F7–F9 400 Pa

Recommended final pressure loss of the filter (EN13053:2006 E)

■ G3–G4 150 Pa

■ F5 (M5), F6 (M6), F7 200 Pa

■ F8–F9 300 Pa

Max. thermal resistance:

■ 70 °C

#### CONSTRUCTION AND DESIGN

- The bag filtration inserts are made of unwoven polyester textile with high absorption capacity.
- The compact filter inserts are made of submicron glass fibre fabric set in a compact self-supporting plastic frame.
- The filtration inserts G3 and G4 are used for section 500 mm long and others are used for sections that are 750 mm long.

#### RECOMMENDATIONS

- F8 and F9 should only be used as a second or third filtration stage behind the fan.

#### REMARK

- The filtration bags can not be regenerated, when the limiting pressure loss is reached, it is necessary to change them.

### COMPACT FILTER

These compact filters are designed for the filtration of dust; they separate fine dust particles and aerosols from the air. They are suitable for normal as well as special applications with increased service life and variability requirements. They are used in the air-handling unit as post-filters or pre-filters of filters for micro-particles.

Compactness (arbitrary options of the flow direction and fitting position), shorter assembly, large filtration area (triple that compared to bag filters) and thus significantly longer service life are the main advantages of these filters. Inserts are made of a submicron glass fibre fabric set in a compact self-contained plastic frame. The compact filters can be used for higher volume air-flow rates (can withstand higher air-flow speeds, maximum end pressure loss can reach up to 800 Pa).

The compact filters are offered in a range from M6–F9 filtration classes. They can be fitted in mounting frames or sliding walls. The filters are always replaced from the „dirty“ side.

Filtration class:

■ M6–F9

Final pressure loss of the filter specified by the manufacturer:

■ 450 Pa

Recommended final pressure loss of the filter (EN13053:2006 E)

■ F5 (M5), F6 (M6), F7 200 Pa

■ F8, F9 300 Pa

Max. thermal resistance:

■ 60 °C

## XPHT FILTER SECTION

### GREASE FILTER

#### CHARACTERISTICS

- These filtration cells are especially used as pre-filters to catch high concentrations of the largest dust particles (in foundries, smelting works, etc.), but their main use is to catch grease and oil aerosols at the outlet from bakeries, kitchens, grills, etc.
- The grease filter assembly is also equipped with a stainless tray to catch the separated waste particles (grease, oils). The assembly is fitted with metal filters of 20 mm thickness and G3 filtration class.
- The grease filter sections are fitted with G3 filtration class metal filter inserts.
- As the metal filters are not able to separate the finest aerosol drops, it is necessary to use additional filtration stages in those assemblies containing a plate or a rotary heat exchanger to avoid fouling of the heat-exchanging surfaces. The correct selection of the suitable filtration class of these additional stages depends on the specific application and the customer's requirements. As a basic solution, the following assembly is recommended: grease filter, G4 filter + F7 filter.
- This section is equipped with service doors with swivel locks and hinges. These doors enable easy access to the filters and their inspection for condition, fouling and their maintenance and exchange.

#### PARAMETERS

- |  |        |
|--|--------|
| ■ Filtration class:  | G3     |
| ■ Recommended final pressure loss of the filter (EN 13053:2006E):  | 150 Pa |
| ■ Final pressure loss of the filter specified by the manufacturer: | 150 Pa |
| ■ Max. thermal resistance:   | 100 °C |

#### CONSTRUCTION AND DESIGN

- The reclaimable metal filter insert consists of the aluminium frame in which the filtration screen made of special interlaced aluminium wire is fitted. The front and back side of the filter is protected by a firm screen made of aluminium expanded metal lath.
- Equipped with a removable stainless tray.
- The filter can also be delivered in a stainless steel version.

#### MAINTENANCE

- Filter maintenance consists of removing it from the section and washing it in hot water (maximum 80 °C) and detergent.

#### REMARK

- If there is an XPK panel at the inlet to the section, we recommend using a panel with the maximum aperture, i.e. a PP panel – full cross-sectional area to efficiently utilize the filtration area (to equalize the speed profile of the air flow).

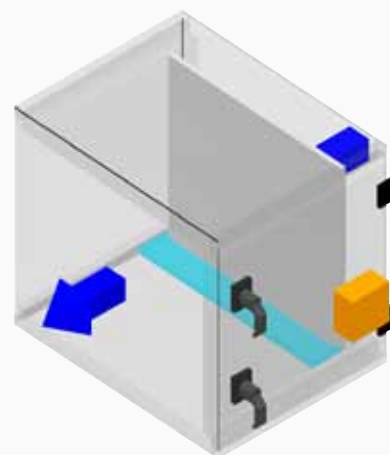
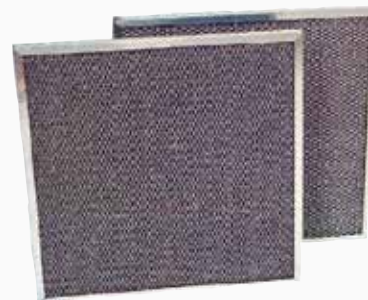



## XPHU FILTER SECTION

### ACTIVE CARBON

#### CHARACTERISTICS

These filter sections are equipped with a filtration system with active carbon. Shaped carbon pellets with a large filtration surface (up to 1250m<sup>2</sup> per gram of active carbon) are enclosed in the cartridges and evenly positioned in the mounting frame. Standard cartridge length is 450 mm (625 mm on request). Active carbon cartridges need to be ordered for a specific application, i.e. it is necessary to know the gas composition. The carbon can be untreated (for common gases) or impregnated to filter hard to absorb gases (like ethane, methane, ammonia and carbon dioxide). The fouling rate is checked by regular weighing of the cartridges. For that purpose, it is advisable to keep records. The cartridge service life, i.e. the maximum absorption capacity, equals the maximum weight increment (see the table below) which depends on the composition and concentration of harmful gases as well as on the operating time. When the maximum absorption capacity has been reached, the cartridges must be replaced. As the complete cartridge must be reactivated, it is advisable to possess a spare set of filter cartridges. Active carbon containing toxic substances, radioactive impurities or PCB cannot be reactivated! The net weight of one 450 mm long cartridge refill is 2000 g while the total weight of the filled cartridge is 2500 g.

#### SELECTION

When working on a selection, the following should be kept in mind:

- Active carbon is very sensitive to dust and so it's necessary to use fore-filters of the filtration class F7 or better.
- To filter off dust from the active carbon, it is advisable to place another F7 class filter after this assembly.
- Contaminants to be separated must be absorbable.
- It is necessary to know the composition of the contaminants and their concentration for the proper selection of the active carbon type
- Pressure loss on active carbon cartridge will not increase
- Standard cartridges absorb organic hydrocarbons and scents
- Specially designed cartridges can absorb:
  - ammonia and acid vapours from the air, sulphates, formaldehyde and phosphates from the air, mercury vapours and amines from the air, radioactive methyl iodide
- If various harmful substances are to be filtered, it is necessary to use multistage filtration with suitably impregnated active carbon.

USE OF STANDARD ACTIVE (NOT IMPREGNATED) CARBON CARTRIDGES

Group # 1	Group # 2	Group # 3
very good adsorption 20-50 % of AC weight	good adsorption 10-18 % of AC weight	<i>Note: It is necessary to use impregnated AC</i> very small or no adsorption ability 0-8% of AC weight
toluene, xylene, petrol, phenol, benzene, perchlorethylene, styrene, acetates, kerosene, turpentine, kitchen odour, smoke-box and meat industry odours, harmful welding gas, sewage treatment plant odours, body odour, adhesive and brazing harmful gas, tobacco smoke, hospital odours, disinfectants, benzol	ether, anaesthetics, acetone, methyl alcohol, phosgene, acetates, smog gases	acrolein, ethane, propane, ethylene, chlorine, methane, ammonia, carbon dioxide, amines, alkaline and acid vapours, HCl, SO <sub>3</sub> , NO <sub>x</sub> , sulphates, hydrogen sulphides, organic sulphur compounds, formaldehydes, mercury vapours, radioactive methyl iodide and phosphanes



## XPTV WATER HEATING SECTION

### CHARACTERISTICS

- High efficiency of heat transmission
- Energy saving operation

### PARAMETERS

Max. water temperature: 130 °C  
Max water pressure: 1,5 MPa

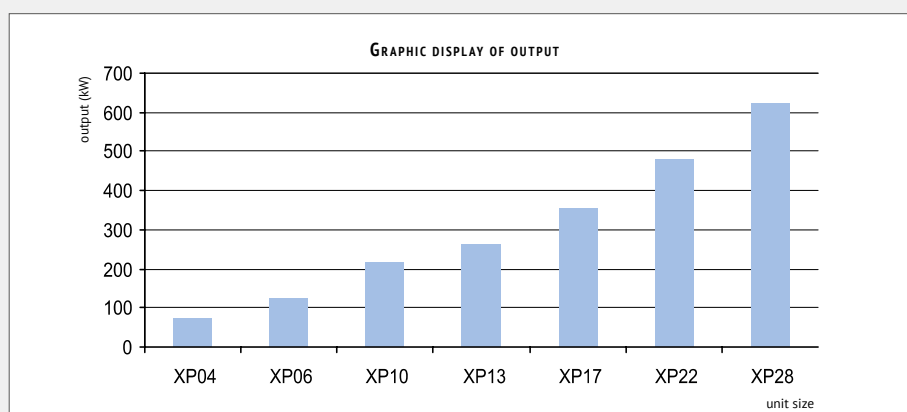

### CONSTRUCTION AND DESIGN

- External casing of exchangers is made of zinc-coated metal sheets. Water heaters are made of Cu tubes with diameter of 12 mm (XP 10-28) and 10 mm (XP 04-06) (geometry) and with aluminium vanes put on and overlaped with spacing of 2,1 mm.
- Collectors and connecting sockets are welded from steel tubes.
- All heaters are tested for leakage by air pressure of 3,6 Mpa under water at temperature of 10 – 30 °C.

### RECOMMENDED ACCESSORY

- Anti-freeze sensor
- NS 130 Mixing set SUMX

### CONTROL AND PROTECTION

- Water heaters are normally equipped with automatic air-outlet valves TACO.

### RECOMMENDATIONS:

- Always install filter in front of heater.

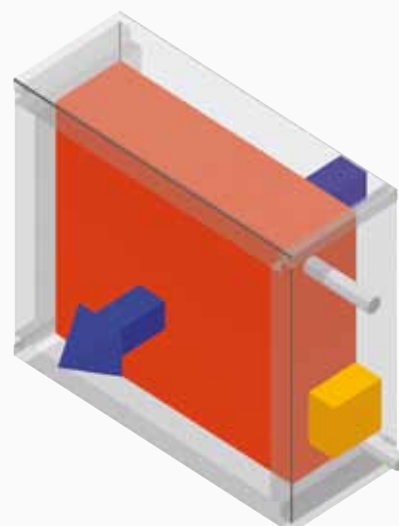

# + AIR HEATING



## XPTE ELECTRIC HEATING SECTION

### CHARACTERISTICS

- High efficiency
- Low-temperature heating rods

### PARAMETERS

Electric voltage:	3 × 400 V / 50 Hz
Electric protection:	IP 44
Minimal air-flow velocity:	1,5 m/s

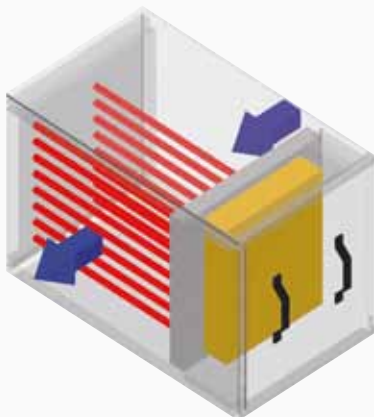
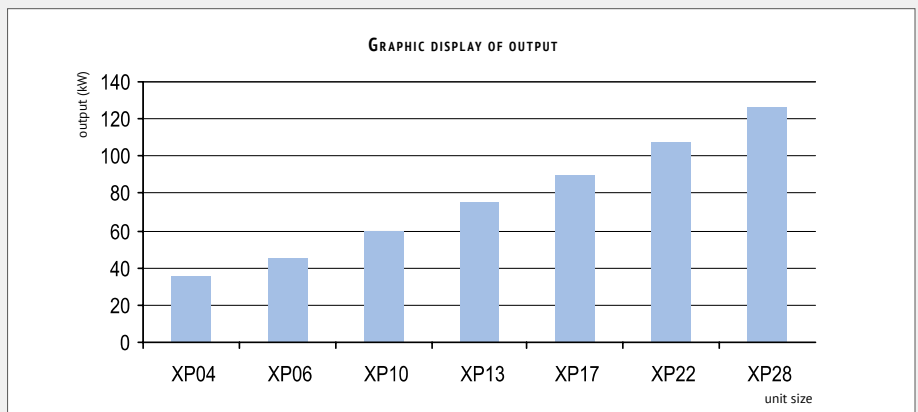

### CONSTRUCTION AND DESIGN

Heat transmission surface:

- Heat transfer is provided by fin-strippled stainless heating rods with large heat transmission surface.

Connection:

- Easy connection is enabled by connecting the cables to the prepared terminals in the switch box of the unit.

### VERSIONS

- EO – relay control
- EOS – semiconductor control
- EOSX – control by sections

### PROTECTIVE ELEMENTS

- Heaters are equipped with two-stage protection by two independent thermostats.
- Ideal control is provided by the control units from REMAK.

### RECOMMENDATIONS:

- Always install filter in front of heater.

## XPTG GAS HEATING SECTION

### CHARACTERISTICS

The casing of the section is made of aluminium frame sections and 50 mm thick thermally insulated panels. The air is heated by flowing around the combustion chamber and its tube plate.

A flange for the burner mounting is situated on the front (service) side of the heat exchanger. The flue gases are drawn off via the chimney outlet (optionally on the rear side of the section). Sections are delivered in two versions - either with or without the bypass. The bypass version is equipped with a damper to regulate air flow. Furthermore, the gas heater section is equipped with a triple safety thermostat and a condensate draining outlet (1/2" pipe).

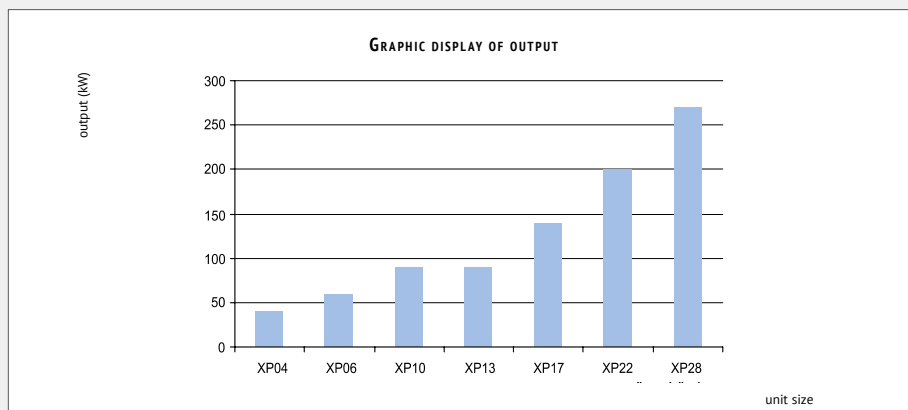

### CONSTRUCTION AND DESIGN

- As standard, the air is heated by Weisshaupt burners.
- A burner operated in an outdoor environment must be provided with a heating cable switched by the thermostat. As standard, this set is included in deliveries marked as TKW 53 for burners WG 10, WG 20, or as TKW 88 for burners WG 30, WG 40.
- The XPTG gas heater section must be connected to the air duct via a dilatation insert heat resistant up to 200 °C.
- This section can be delivered for indoor as well as for outdoor use. The burner and triple safety thermostat of the outdoor version are protected by covers.
- The smoke flue is not included in the delivery.
- Safety and control elements delivered with the section must be connected to ensure proper, reliable and safe operation. Details are included in the table in The AeroMaster XP Installation Instructions.

### RECOMMENDATIONS:

- When designing the air-handling unit, we recommend placing the gas heater section at the end of the inlet part of the air-handling unit.

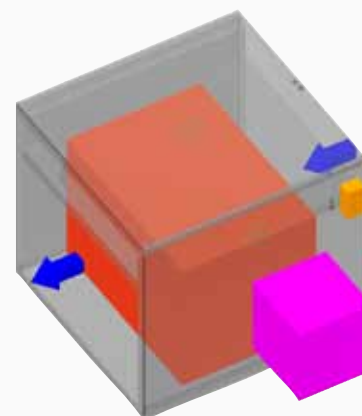



#### DESIGN VARIANTS

- Single-compressor design
- Double-compressor design



## INTEGRATED COOLING

Compressor units along with optimized Remak exchangers serve as sources of cold for AeroMaster Cirrus and AeroMaster XP air-handling units .

#### CONFIGURATION

We can deliver either a fully operational unit with all the components (compressors, exchangers, etc.) of the compressor circuit interconnected and the piping filled with coolant so all you need to do is to switch the unit on, or a disassembled unit.

The unit assembly includes the necessary safety and control elements, separate distribution board and suitably dimensioned optional injection valves. Depending on the output, respectively on the requirement of the control level, the unit can be fitted with one or two compressors.

When designing the system, we only use quality components from approved suppliers.

#### CONTROL

- The unit's output can be controlled on several levels depending on its application.
- The unit's output is controlled by switching the compressor using an external signal, i.e. ON/OFF system. If a double-compressor arrangement is used, 0/50/100 % output control can be achieved by switching the compressors in sequence.
- If an electronic controller is used, the switching of the compressors is then controlled depending on the number of operating hours elapsed.
- If the Digital Scroll™ compressor is used, the refrigerating capacity will then be controlled within a given range steplessly.
- To avoid the whole system's efficiency being reduced, REMAK compressor units are antifreeze protected.

#### INTEGRATED COOLING ADVANTAGES

- Simplifies and makes air-handling unit commissioning cheaper
- Saves room (no need for installation of outdoor sources of cold)
- Saves operating costs, among others by creating suitable conditions for heat removal (high EER factor – energy efficiency factor)
- Simple, fast and cheap servicing (just one device)
- Minimum length of distribution pipes – minimum volume of coolant
- Low sound level transmitted to the surroundings
- Minimised damage in the event of failure (just one of the sources of cold is disabled)

#### INTEGRATED COOLING SYSTEM HAS SOME LIMITS:

- Limited output, especially due to limited condensation area and small difference between coolant and air temperatures
- higher pressure loss on the relief air side

#### REMAK SOLUTION ADVANTAGES

- customised solution without catalogue compromises
- option of economy or comfort solution
- simple and therefore failure-free design
- High efficiency due to:
  - minimised effective area of the exchangers
  - selection of suitable components in the circuit (injection valves, etc.)
  - system designed for optimum operating temperatures
- optional delivery of a „plug and play“ unit or a disassembled unit

KHX-S1 COMPRESSOR UNITS											
Model	Refrigerating capacity kW, R407C, Tc=+45 °C				Unit dimensions	Weight	Noisiness	Voltage	Operating current	Distribution board	
	Evaporating temperature T <sub>E</sub>									H×W×D (mm)	kg*
	+6 °C	+9C	+12 °C	+15 °C	H×W×D (mm)	kg					
KHX-S1-4	4,2	4,7	5,3	5,9	540×400×415	32	34	230	7,4	407×304×148	5
KHX-S1-5	5,2	5,8	6,5	7,2	540×400×415	34	34	400	3,8	407×304×148	5
KHX-S1-7	6,7	7,5	8,4	9,3	540×400×415	37	34	400	4,7	407×304×148	5
KHX-S1-8	7,9	8,9	10,0	11,1	540×400×436	39	37	400	5,6	407×304×148	5
KHX-S1-9	9,4	10,5	11,8	13,1	540×400×450	40	37	400	6,3	407×304×148	5
KHX-S1-12	11,4	12,9	14,4	16,0	540×400×470	44	37	400	7,6	407×304×148	5
KHX-S1-14	14,8	16,4	18,2	20,2	540×400×490	44	41	400	9,1	407×304×148	5
KHX-S1-17	16,8	18,8	21,0	23,3	540×400×490	52	41	400	10,5	407×304×148	5
KHX-S1-19	19,1	21,4	24,0	26,8	540×400×490	52	41	400	12,8	407×304×148	5
KHX-S1-22	23,4	26,1	29,0	32,2	540×400×525	71	43	400	14,4	407×304×148	5
KHX-S1-25	26,2	29,3	32,7	36,3	540×400×582	73	43	400	15,5	407×304×148	5
KHX-S1-29	30,6	34,2	38,2	42,4	540×400×582	75	43	400	18,2	407×304×148	5
KHX-S1-33	35,1	39,3	43,8	48,6	540×400×582	87	44	400	20,1	500×400×240	17
KHX-S1-36	38,5	43,6	49,0	55,0	540×400×601	91	47	400	23,1	500×400×240	17
KHX-S1-43	44,8	50,2	56,0	62,2	690×400×601	97	49	400	29,2	500×400×240	19
KHX-S2 COMPRESSOR UNITS											
KHX-S2-38	38,2	42,8	48,0	53,6	690×500×494	106	44	400	25	500×400×240	19
KHX-S2-44	46,8	52,2	58,0	64,4	690×500×525	147	46	400	28,4	500×400×240	19
KHX-S2-50	52,4	58,6	65,4	72,6	690×500×582	152	46	400	30,8	500×400×240	19
KHX-S2-58	61,2	68,4	76,4	84,8	690×500×582	156	46	400	36,1	600×400×240	20
KHX-S2-66	70,2	78,6	87,6	97,2	690×500×582	156	47	400	40,3	600×400×240	20
KHX-S2-73	77,0	87,2	98,0	110,0	690×500×601	164	50	400	45,6	600×400×240	20
KHX-S2-87	89,6	100,4	112,0	124,4	690×500×601	169	52	400	58,2	700×500×280	23

\* The weight includes the distribution board; applies for calculation of the units in ON/OFF versi

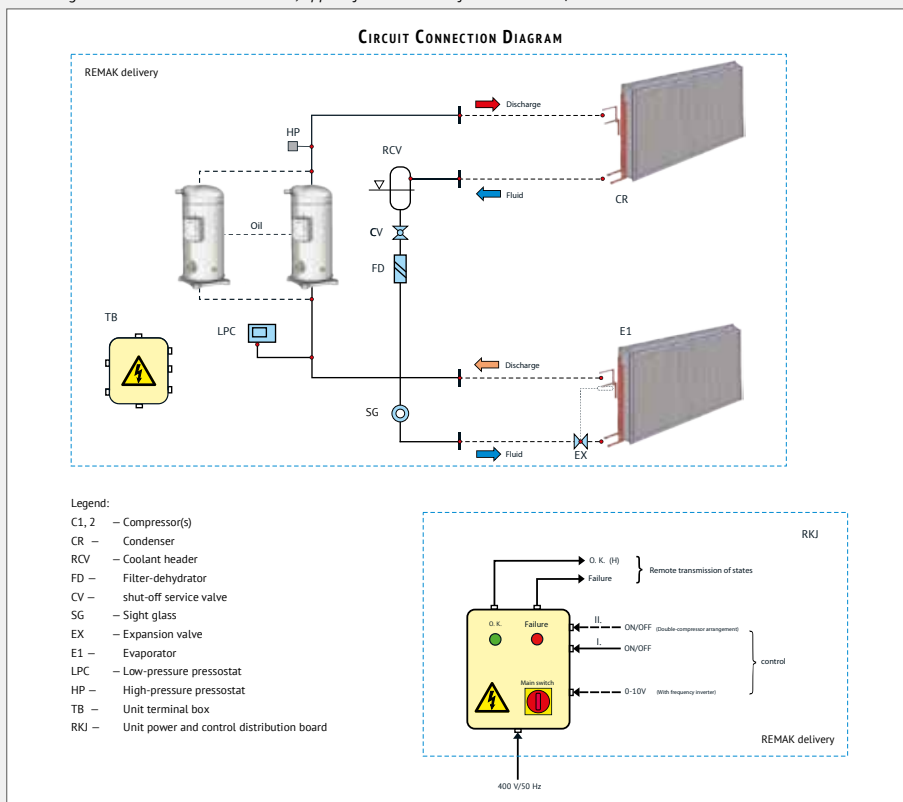



## XPYO COOLER SECTION

### CHARACTERISTICS

Boundary conditions for CHV:

- 3 m/s, 30 °C / 40 °C, 280 m (98 kPa), 6/12 °C

Boundary conditions for CHF:

- 3 m/s, 30 °C / 40 °C, 280 m (98 kPa), R407C, evaporating temperature 5 °C

### PARAMETERS

Water cooler:

- Max. pressure of cooler water 1,6 MPa

Direct cooler:

- coolant R407 (R410 or other on demand)

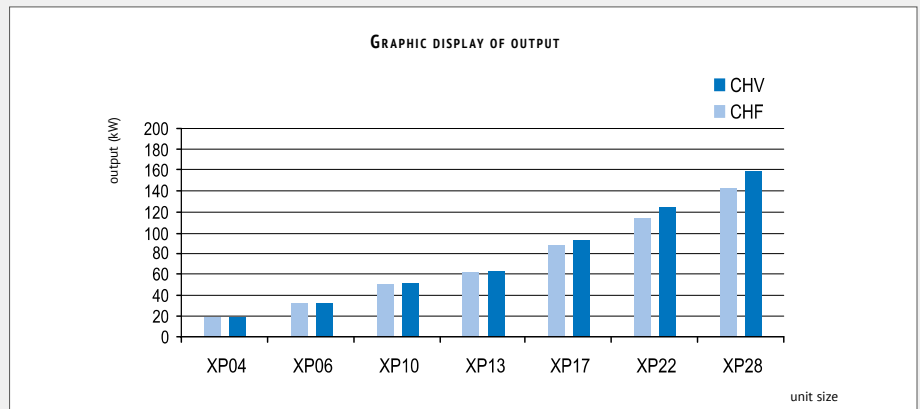

### CONSTRUCTION AND DESIGN

- The built-in consists of a water or direct cooler. The heat transmission surface consists of aluminium fins put on copper tubes and overlapped.
- Water cooler connection: thread G1" – 2"
- Direct cooler is filled with shielding gas.
- Section is equipped with stainless tray and condensate drain kit.

### RECOMMENDATIONS

- Protect the heat exchange surface from contamination by means of a filter.

## XPJZ STEAM (ISOTHERMAL) HUMIDIFICATION SECTION

### CHARACTERISTICS

- An easy and hygienic solution for all humidification requirements.
- These sections are designed for installation of the humidifier's distributing tubes.
- The standard section length is 1250 mm.

### PARAMETERS

- Calculation of the required steam capacity and design of the suitable humidifier is based on the input parameters and preformed using the AeroCAD design software.

### CONSTRUCTION AND DESIGN

- The section is equipped with a condensate drainage tray ended with a G 1/2 union fitting for XP04-10 and with a neck 38 mm in diameter for XP13-28.
- With the complete deliveries, i.e. the section includes a steam humidifier, the distribution tubes are installed in the section.
- The section is equipped with a service panel to enable easy access to the tray and distribution tubes.

### RECOMMENDATIONS:

- For higher outputs of the steam humidifiers, it is possible to select between the electrode and economical gas generator.
- It is advisable to place a filtration section equipped with at least F6 class filters before the humidification section.
- To protect the fan units, it is advisable to situate the humidification section behind the fan (in positive pressure side).

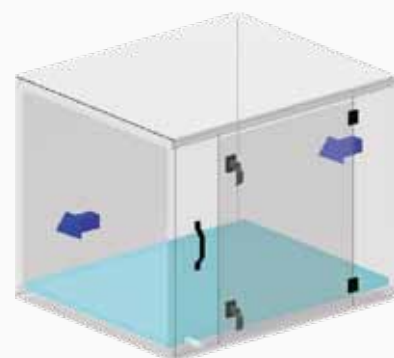



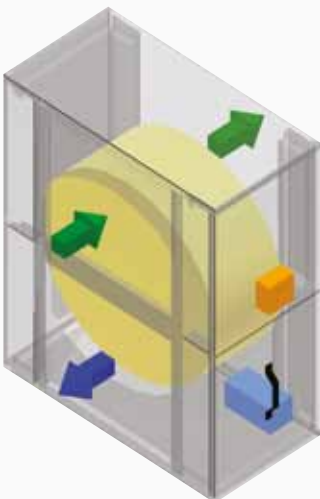
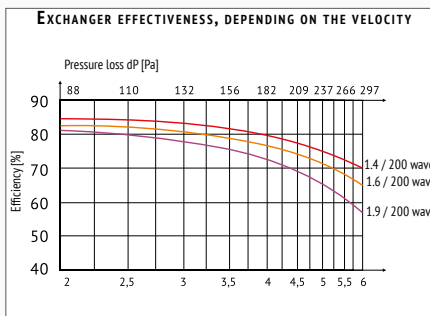

## XPXR ROTARY HEAT EXCHANGER SECTION

### CHARACTERISTICS

- Provides heat (humidity) recovery from exhaust air to inlet air brought through multi-plate aluminium rotor. Investment return in 1 year max. High efficiency.

### PARAMETERS

- Motor voltage: 3x 400 VY / 230 VD, 50 Hz
- Efficiency: to 85 %
- Maximal mixing ratio (inlet & outlet air): 5 %
- The maximum air-flow velocity is limited to the velocity related to the rotor cross-section: maximum 4.0 m/s or 6.0 m/s using a special design.

### CONSTRUCTION AND DESIGN

- **Heat transmission surface:** The rotor is made of thin aluminium sheet, and in an enthalpy version with sorption coating. Depending on the required heat-exchange efficiency, there are three rotor flute heights to choose from: 1.4, 1.6 and 1.9 mm.
- **Gear:** A short-circuit armature asynchronous motor with a gearbox.
- The rotary heat exchanger is equipped with a flushing chamber.
- Versions with greater corrosion resistance are delivered with an epoxy-coated rotor and a powder-coated casing frame.
- The section is equipped with a removable panel on the operator's side.
- Delivery with a rotor for: heat transfer and/or heat and humidity transfer (enthalpy)
- Heat exchangers are designed to transfer air heat at temperatures ranging from -20°C to +55°C, or up to +100°C if made to special order.
- Operation at temperatures below -20°C is possible providing the antifreeze protection of the heat exchanger is ensured.
- To extend the control range (using the XPFM frequency inverter and VCS control unit), the heat-exchanger drive is ready for 85 Hz. If another type of control is used or there is no control, the heat exchanger is delivered with a drive ready for 50 Hz. Operation using 18-85 Hz frequencies enables the rotor speed to be lowered to a range with a noticeable reduction of the heat-exchange efficiency and smooth transition to the shut-down state. This is achieved by the power supply using 85 Hz frequency and a smaller pulley so that the maximum rotor speed remains in the optimum range of 10-13 rpm.

### RECOMMENDATIONS

- On all connected sides of heat exchanger section there must follow the service sections to allow access to rotor itself.
- Rotor speed can be controlled by frequency converter or independent controller.
- Maximum velocity of transported air through the rotor is 4.0 m/s. A version for higher air velocities can be ordered for an additional charge.
- Inlet and outlet air for the heat exchanger must be filtered to avoid fouling of the rotor's cells.
- To enable service, maintenance and cleaning of the heat exchanger, it is necessary to provide a service access from both sides of the heat exchanger by inserting the access section (service section, filtration section, etc.) in the air-handling assembly, respectively to enable the heat exchanger to be pulled out of the air-handling unit (more than 1/2 of the heat exchanger construction width).
- The flushing chamber carries out its function only if the directions of the inlet and outlet air flow oppose each other.
- If extreme humidity and its condensation on the rotor is expected, the heat exchanger can be fitted in the factory with a collecting tray for the condensate draining; a special order has to be placed.

## XPXQ CROSS HEAT EXCHANGER

### CHARACTERISTICS

Plate heat exchanger provides heat transfer by steady flow from outlet air to the inlet air brought in through exchanger with large surface.

- Nearly perfect separation of air inlet and outlet.
- Investment return in 1 year max.
- Ideal for clean rooms.
- This section can be equipped with a damper to create partial recirculation of the outlet air back to the inlet.

### PARAMETERS

- Efficiency: to 70 %
- Maximum allowed differential pressure: 1800 Pa

### CONSTRUCTION AND DESIGN

Heat transmission surface:

- The mixing sections are produced in various lengths with alternative locations of the dampers. For details, refer to the AeroCAD.

Sections can be delivered either:

- Without by-pass
- With bypass
- With by-pass and mixing section

The bypass version s equipped with regulating dampers fitted on the common shaft.

The section, in the lower line, is equipped with an easy-to-access tray for the condensate draining ended with a G 1/2 union fitting for XP04–10 and with a neck 32 mm in diameter for XP13–28.

When installing the plate heat exchanger, the differential pressure in the cubicle must not exceed 1.8 kPa.

### MATERIALS AND DESIGN

- Vanes: aluminium as standard  
Epoxy-coated vanes for greater corrosion resistance
- Frame: aluminium corner profiles, side plate made of Aluzinc sheets  
Powder-coated for greater corrosion resistance

### RECOMMENDATIONS

- Section should be equipped with removable drop eliminators.
- The bypass dampers are controlled by actuators working in proportional or discrete modes; suitable type can be selected in the design program.
- A filter should always be installed on front of the heat transmission to protect the heat exchanhe surface from contamination.
- It is advisable to place a drop eliminator (not included in the section) behind the outlet side of the section.

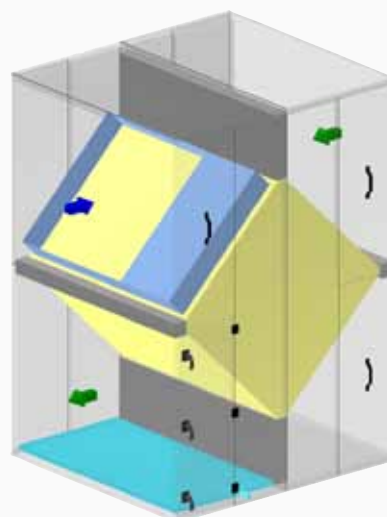



# HEAT RECOVERY



## XPTP GLYCOL CIRCUIT

### CHARACTERISTICS

- The glycol circuit is used to recover heat from the outlet air. Advantage of this method is 100% separation of both air streams and possibility to install the air-handling unit inlet and outlet ducts to different (sometimes even distant) locations.
- High efficiency
- Ideal solution for clean rooms

### PARAMETERS

Efficiency: up to 45 %

### RECOMMENDED AIR FLOW SPEED

- Heater: 3,8 m/s
- Cooler: 2,8 m/s

### CONSTRUCTION AND DESIGN

Two exchangers, a cooler and a glycol heater, are the basic elements of the circuit. The exchanger situated in the outlet air flow takes off the heat and acts as a cooler. The exchanger situated in the inlet air flow radiates the heat and acts as a heater. Glycol Heat Exchangers are designed as standard water heat exchangers intended for the XP air-handling units. The exchangers are interconnected by the ducting and equipment which ensures control and safety functions. The duct system elements and circulation pump are not included in the delivery from REMAK. Solution of ethyl glycol and distilled water is mostly used as heating media.

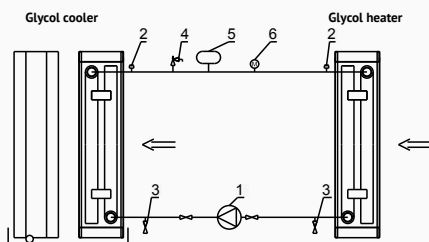

- 1) Circulation pump
- 2) Air-venting valve
- 3) Inlet/outlet valve
- 4) Safety valve
- 5) Expansion tank
- 6) Pressure gauge

### CONTROL

- The control unit ensures control of the glycol circuit in two variants depending on the air-handling unit configuration and the number of outputs used.

#### Variant #1:

- A free digital output of the RWD controller is required for this variant. The glycol circuit pump is switched by the digital output at the request for heating, or by suitable setting of the controller at insufficient heating capacity of the water or electric heater.

#### Variant #2:

- The glycol circuit pump is switched along with the air-handling system. During summer season, the glycol circuit pump can be switched off using a switch on the control unit.

### REMARK

- It is always advisable to install a filter in front of the glycol circuit heat exchangers to protect the heat-exchange insert from fouling.

## XPPO ATTENUATOR SECTION

### CHARACTERISTICS

- Absorbent splitter noise attenuators are intended for attenuation of noise coming from the fans both at the inlet and the outlet.
- These are manufactured in several modular lengths depending on the space conditions of the installation site and the required attenuation.

### CONSTRUCTION AND DESIGN

- The sections are equipped with splitter TKU. They consist of a moulded frame made of zinc-coated metal sheets and a filling consisting of an absorbing panel that is 100 mm for XP 04 – 10 and 200 mm for XP 13 – 28, covered on both sides by unwoven textile.
- Noise attenuation can also be provided by external attenuators in the duct.

### RECOMMENDATIONS

- To ensure steady air flow, it is advisable to keep a distance of 250 mm from other components in front as well as behind the attenuator.
- We recommend situating this section either in front of or behind the fan.
- In regards to hygiene reasons, it is not advisable to situate this section behind the cooler or humidifier.

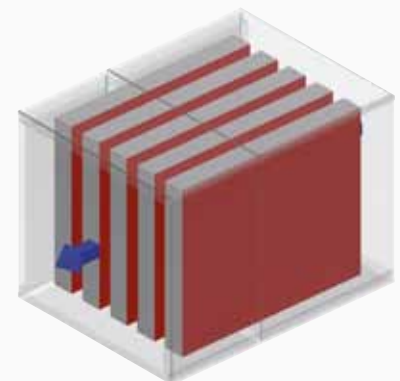

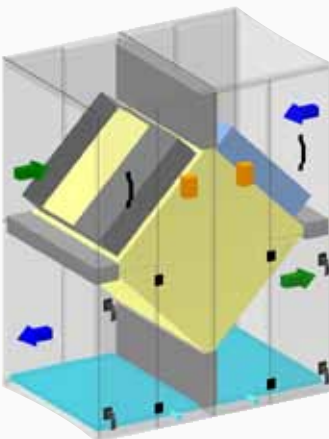
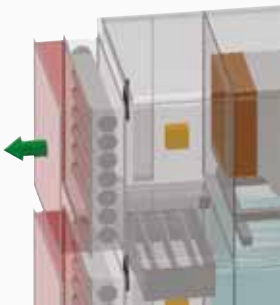
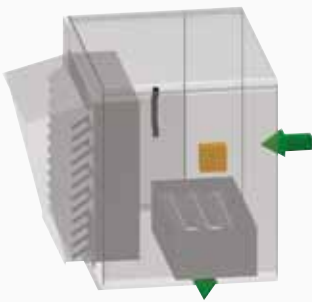

## XPID/XPBD MIXING SECTION

### CHARACTERISTICS

Provides mutual mixing of supply and exhaust air in required ratio.  
Optional section length.

Remark

Short section is called XPIS.

### PARAMETERS

- Mixing can be set up in the range of 0 – 100 %

### CONSTRUCTION AND DESIGN

- Mixing section consists of a section equipped with a system of internal and external dampers which provide the required way of mixing.
- Mixing sections are made in different length types with optional location of shutters. For details see AeroCAD software.
- Short sections – are intended for internal dampers installation, long sections are intended for external shutters installation.
- The mixing damper is controlled by a proportional actuator; its mode can be selected in the AeroCAD design software.

#### ■ Stacked

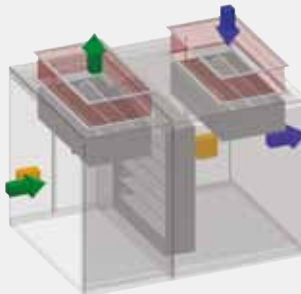

#### ■ In series

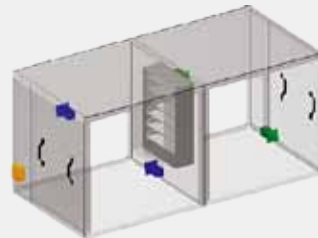

### RECOMMENDATIONS

- If a mixing damper is installed, then the fan must be placed in the inlet line after this section and in the outlet line before this section to ensure recirculation.
- In the inlet line, the fan must be placed after mixing; and in the outlet line, before mixing.

## XPTP (VO), XPQR (CHV/CHF): SECTION WITH COVERED FEEDS

### CHARACTERISTICS

- These sections are designed to be installed into assemblies with 1-8 row VO/CHV and CHF exchangers, mainly in outdoor air-handling units.
- Energy-saving operation

### PARAMETERS

- Parameters of these exchangers are the same as with the exchangers without covered feeds.

### CONSTRUCTION AND DESIGN

- XPQR section is equipped with a tray for the condensate draining ended with a G G1/2" union fitting for XP04-10 and with a neck 32mm mm in diameter for XP13-28.
- The section overhang covers media connections, respectively the exchanger output control components, without need for additional protection against weather effects.

### RECOMMENDATIONS:

- Always install filter in front of section.
- Protect the heat exchange surface from contamination by means of a filter.
- When designing the air-handling unit, we recommend placing the gas heater section at the end of the inlet part of the air-handling unit.

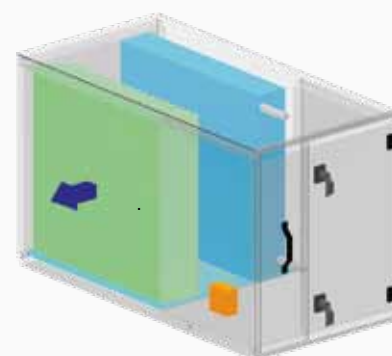

## XPUO DROP ELIMINATOR SECTION

### CHARACTERISTICS

The section is used to catch condensate behind the heat transmission surfaces of coolers or exchangers.

### CONSTRUCTION AND DESIGN

- The eliminator consists of a frame made of stainless metal sheets where vanes made of cured polypropylene are placed. Water outlet is provided by stainless tray ending with an outlet with screwing G1/2 for XP 04-10 and piped outlet with diameter 32 for XP 13-28.
- The section is equipped with a service panel that provides easy access to the eliminator. It can be easily removed from the section.

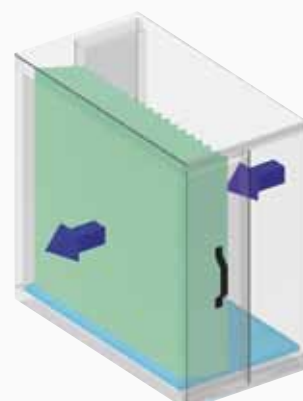

# ACCESSORIES



## XPJP EMPTY SECTION

### CHARACTERISTICS

- In the air-handling unit, the empty section is located where the proper function of the individual sections require it. For example between attenuator and filter section. It's also used to spatially organize the unit.

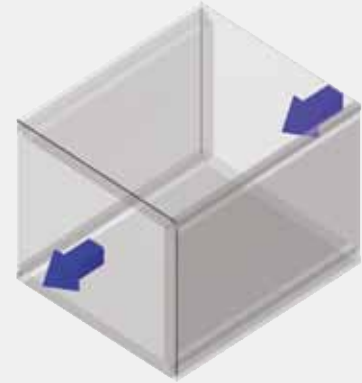

## XPJD DIFFUSER SECTION

### CHARACTERISTICS

- In some cases a diffuser section is placed on the fan section with a fan with double inlet impeller. Such cases are when steady air flow through the whole profile is required. (attenuator section, heat exchanger or filter section).

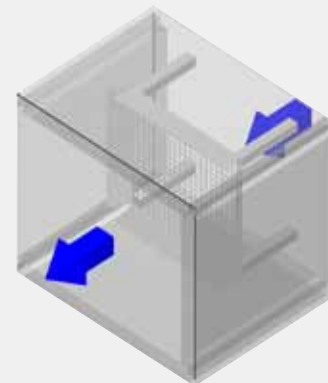

## XPRO BASE FRAME

### CHARACTERISTICS

- It is made of zinc-coated metal sheets and is an integral part of every section which forms the unit's platform.
- It comes in three heights: 150 mm, 300 mm and 400 mm and can be equipped with height-adjustable feet.
- Maximal frame length is 3000 mm, which also specifies the maximal length of the block of sections.

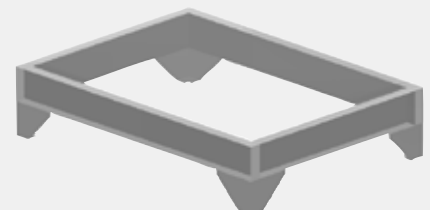



# ACCESSORIES

## XPJS SERVICE SECTION

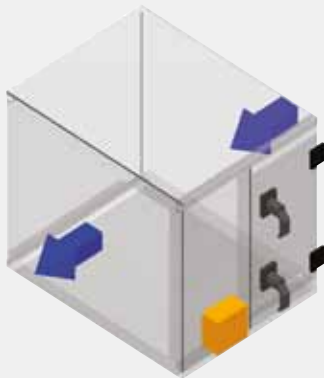

### CHARACTERISTICS

- Section is used for service purposes
- inside the unit and for installation of the measuring and control elements.
- Easy access is provided by the wide door.
- The section can be equipped with an easy-to-access tray for the condensate draining ended with a G 1/2 union fitting for XP04-10 and with a neck 38 mm in diameter for XP13-28.



## XPK CLOSING PANEL

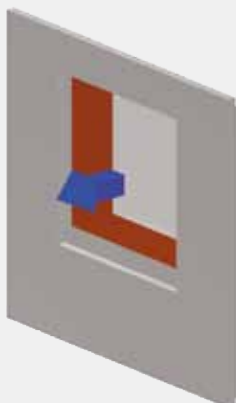

### CHARACTERISTICS

- The XPK panel makes up, along with other types of panels, the casing of the air-handling unit XP. The panels are placed on the frontlets of the units, and they're fixed to them by the screws M6x40 with countersink head.
- XPK panels are either full or they have an integrated aperture for air inlet/outlet of a given connection size and for the appropriate connecting elements. By means of these elements, the accessory of XP units is fixed to the unit. (DV, LKS).



## VDV ELASTIC CONNECTION

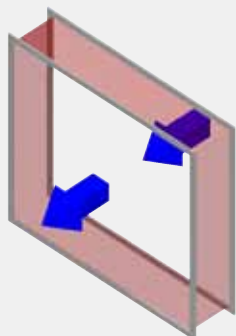

### CHARACTERISTICS

- The elastic connection stops
- vibration transfer between unit and the ductwork.
- It consists of flanges made of zinc-coated metal sheets and a PVC belt stiffened by polyamide textile. The flanges are connected by means of a conductive copper girdle.
- The range of operating temperatures is from -30 °C to +80 °C.





## COMPREHENSIVE SOLUTION

AeroMaster XP air-handling units can be controlled by the VCS control system. This system can be included in the delivery and can be automatically designed using AeroCAD design software.

Major advantages of REMAK control systems:

- Reliability
- Simple to use
- Optimized for a specific air-handling assembly

## VCS

VCS control units are compact control and power distributors used for the decentralized regulation and control of air-handling systems. They provide the equipment with high stability and safety while allowing easy control, including viewing the operating states.

### MAIN FEATURES

The VCS control unit is intended for the following:

- The VCS control unit is intended for the following:
  - Complex autonomous control of air-handling systems
  - Room air temperature control (cascade control)
  - Supply and power actuation of air-handling systems
  - Protection and safeguarding of connected components

Sophisticated control algorithms ensure system stability, user-friendly control and energy savings. Another advantage is that the control unit's features also contribute to energy savings in air-handling system operation:

- Possibility to set the unit to 2 temperature modes
  - Comfort
  - Economy
- Additional setting options:
  - Optimized start
  - Temperature start-up
  - Night chilling
- Time schedule setting options (daily or weekly time schedules)
- Precise drive control using data communications through the Modbus RTU bus
- Precise analogue control of controlled peripheral units (according to controlled component)

## FREQUENCY INVERTERS

The frequency inverters are optimized to power the fan motors. They enable fan motor speed control and thus the air-handling unit's air flow rate control.



## ACTUATORS AND SENSORS

### CAPILLARY THERMOSTAT

Auxiliary antifreeze protection sensor. The capillary tube of this thermostat is installed through the whole air-flow cross-section. If the temperature falls below the permissible level, this thermostat will activate antifreeze protection of the connected control system.



### TEMPERATURE SENSORS

The return water temperature is sensed by the high-speed response NS 130 / Ni1000 temperature sensor to enable the control system to react fast enough when the temperature falls below the permissible level. The sensor is situated directly in the water heat exchanger header on the return water side. Inlet air temperature sensing behind the heater is performed by the NS120/Ni1000 sensor. This sensor serves for both inlet air temperature control as well as antifreeze protection.



### PRESSOSTAT

This is a pressure monitor. It signals exceeding of the preset pressure loss, e.g. filter fouling or fan malfunction.



### PRESSURE GAUGES

Differential pressure gauges.

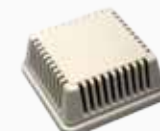

### ROOM THERMOSTAT

This is used to set the required temperature..

### ROOM TEMPERATURE SENSOR

This is used to compare the required temperature and current measured temperature.



### CARBON MONOXIDE SENSORS

These sensors are intended to detect carbon monoxide in indoor areas, e.g. garages.

### CARBON DIOXIDE IN AIR CONCENTRATION ROOM SENSOR

This sensor measures the concentration of CO<sub>2</sub> in the air

### PRESENCE AND MOTION DETECTION SENSORS

They are used to detect the movement of persons in exterior areas for heating, ventilation and air-conditioning purposes.

### VOLATILE SUBSTANCE SENSORS (VOC)

Volatile Substance detection sensors (VOC) detect substances like kitchen vapours, vapours from rotting organic substances, etc.



### CONSTANT PRESSURE/AIR-FLOW CONTROLLER

The control module has been combined with a pressure sensor. Changes in the 0–10 V output signal can be controlled depending on the pre-set differential pressure or required air volume air-flow.





## XPRJ CONTROL UNIT SECTION

### CHARACTERISTICS

The XPRJ section is designed for control unit assembly, which supplies and controls the AeroMaster XP air-handling unit.

### PARAMETERS

Operating conditions:

- 0 to +35 °C

### CONSTRUCTION AND DESIGN

- The air-cooled tray inside the air-handling unit is made of galvanized sheet steel, and has through ventilation and degree of protection IP44.
- A panel fitted with cable grommets is situated next to the service access door.
- Protection of the XPRJ section against dangerous contact with live parts is ensured by a removable cover (guard) which is accessible after opening the service door and removable only using tools; degree of protection IP20.
- The section is provided with a main switch.

### RECOMMENDATIONS:

- The section can be equipped with a heater to protect it against low temperatures, or with a cooling box to protect it against high temperatures (maximum +50 °C).

Recommended position in the assembly:

- In the outlet branch, in the inlet branch behind the pre-heater or heat exchanger, resp. behind the cooling section.



## XPRF FREQUENCY INVERTER SECTION

### CHARACTERISTICS

- The XPRF section is designed for the AeroMaster XP air-handling unit frequency converters to be placed in. Up to 3 frequency inverters can be placed in this section.

### PARAMETERS

Operating conditions:

- 0 to +35 °C

### CONSTRUCTION AND DESIGN

- The air-cooled tray inside the air-handling unit is made of galvanized sheet steel, and has through ventilation and degree of protection IP44.
- A panel fitted with cable grommets is situated next to the service access door.
- The frequency inverters are accessible through the door.

### RECOMMENDATIONS

- The section can be equipped with a heater to protect it against low temperatures, or with a cooling box to protect it against high temperatures (maximum +50 °C).

Recommended position in the assembly:

- In the outlet branch, in the inlet branch behind the pre-heater or heat exchanger, resp. behind the cooling section.

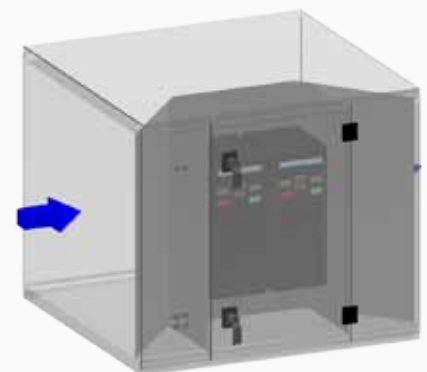

# EXAMPLES OF UNITS

## XPQU

DOUBLE SECTION OF COOLING

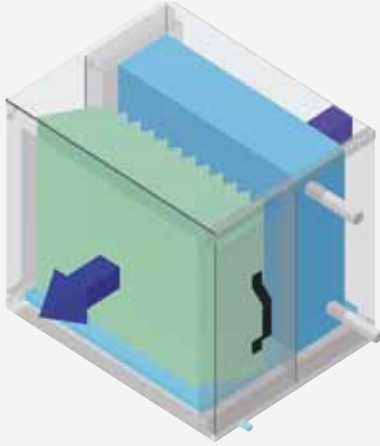

## XPQY

DOUBLE SECTION OF COOLING AND SERVICE

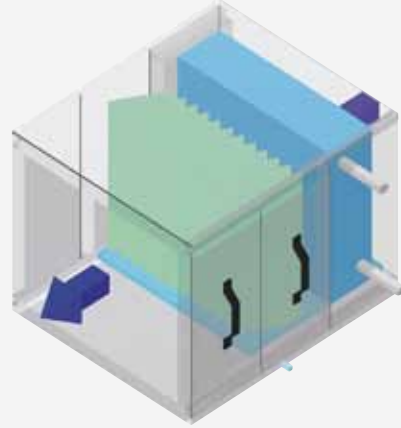

## XPQW

LONG DOUBLE SECTION OF WATER HEATING AND SERVICE

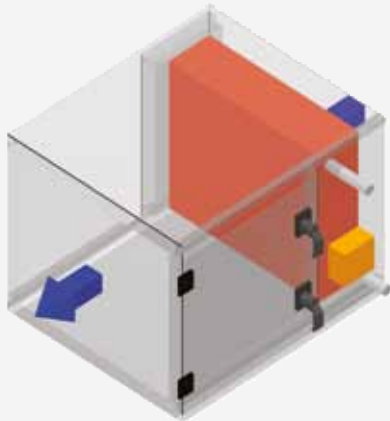

## XPQW

DOUBLE SECTION OF WATER HEATING AND COOLING

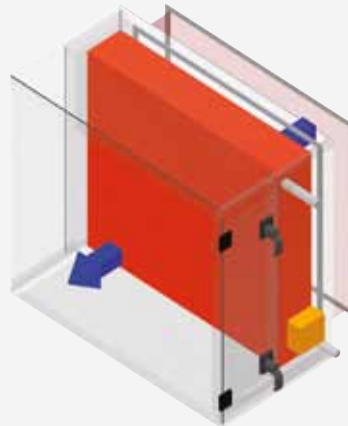

## XPQC

DOUBLE SECTION FILTRATION + WATER HEATING

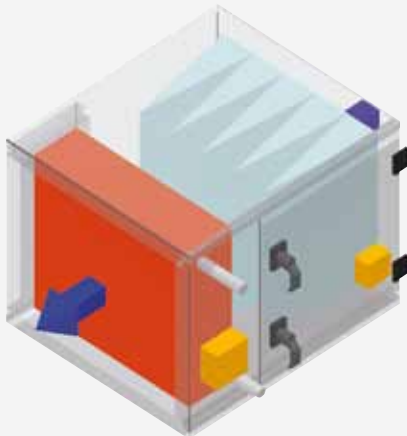

## XPQD

DOUBLE SECTION OF WATER HEATING AND COOLING

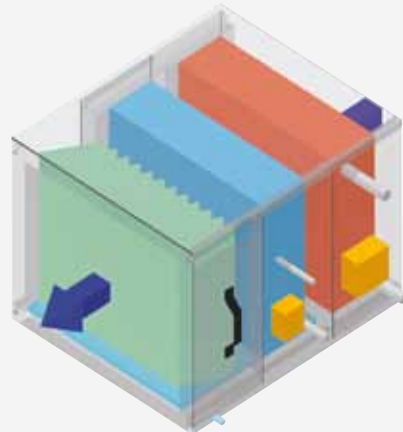

# EXAMPLES OF ARRANGEMENTS

MIXING, FILTRATION, WATER COOLING,  
DROP ELIMINATOR, GAS HEATING

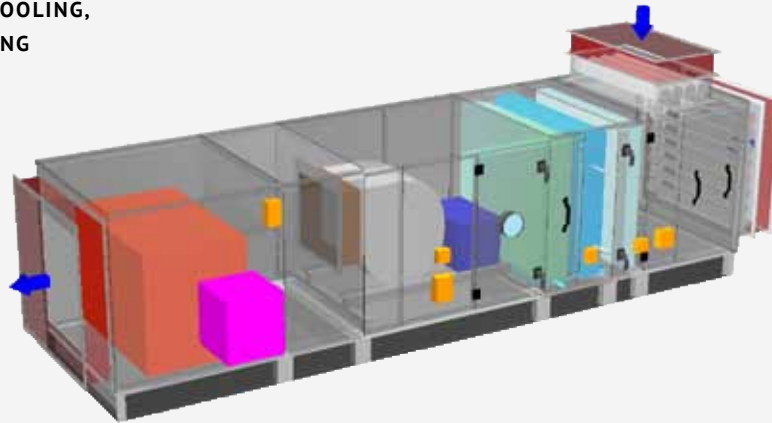

FILTRATION, ELECTRIC HEATING, PLATE HEAT  
RECOVERY, NOISE ATTENUATION

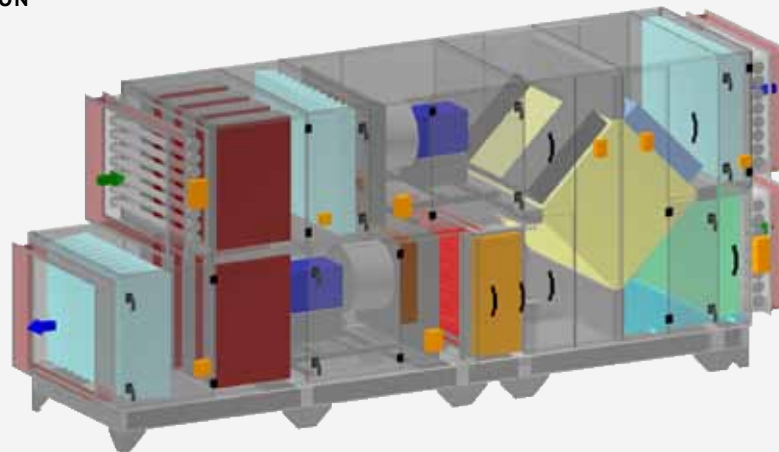

FILTRATION, ROTARY HEAT EXCHANGER, WATER HEATER, ATTENUATOR, COVERED  
FEEDS, INTEGRATED CONTROL UNIT AND FREQUENCY INVERTERS FOR OUTDOOR VER-  
SION

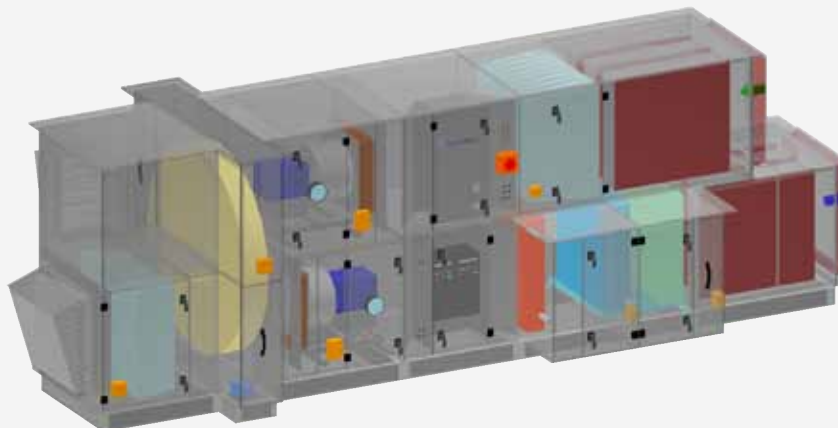



# UNIT DIMENSIONS

SEPARATE SECTIONS									
Function	Designation	Variant	Section length (mm)						
			XP 04	XP 06	XP 10	XP 13	XP 17	XP 22	XP 28
Fan – free impeller	XPAP/XPVP	S	750	750	1000	1000	1250	1250	1500
		D	1000	1000	1250	1250	1500	1500	1750
Fan – spiral with a belt drive, forward curved blades	XPAA/XPVA	S*	750	-	-	1250	1250	1500	1500
		D*	1000	1000	1250	1500	1500	1750	1750
Fan – spiral with a belt drive, backward curved blades	XPAA/XPVR	S*	750	-	-	1250	1250	1500	1500
		D*	1000	1000	1250	1500	1500	1750	1750
Backup fans (stand-by) – spiral with a belt drive, forward or backward curved blades	XPZA	-		1500	1750				
		S	1250	-	-	1750	1750	2000	2000
		D	1500	-	-	2000	2000	2250	2250
		E	-	-	-	-	2250	2500	2500
		X	-	-	-	-	-	-	2750
Diffuser	XPJD/XPNA	-	500	500	500	500	500	500	500
Bag filter	XPHO/XPNH	S	500	500	500	500	500	500	500
		D	750	750	750	750	750	750	750
Compact filter	XPHO/XPNK	S	-	500	500	500	500	500	500
Insert filter	XPHO/XPNV	K	250	250	250	250	250	250	250
Frame filter	XPHO/XPNR	K	250	250	250	250	250	250	250
Active carbon filter	XPHU	D	750	750	750	750	750	750	750
Grease filter	XPHT/XPNT	-	500	500	500	500	500	500	500
Water heater	XPTV/XPNC	-	250	250	250	250	250	250	250
Water heater with covered leads	XPTP/XPNC	S	500	500	500	500	500	500	500
		D	750	750	750	750	750	750	750
Electric heater	XPTE/XPNE	-	500	500	500	500	500	500	500
Gas heater (without by-pass)	XPTG .../N	S	1000	1000	1300	1300	1300	1650	1650
Gas heater (with by-pass)	XPTG .../B	S	870	870	1000	1000	1100	1300	1300
		D	-	1000	1100	1100	1300	1650	1650
		E	-	-	-	1300	-	1650	1650
Direct evaporator/water cooler	XPYO/XPND,XPNF	-	250	250	250	250	250	250	250
Drop eliminator	XPUO/XPNU	-	250	250	250	250	250	250	250
Noise attenuator	XPP0	N	750	750	750	750	750	750	750
		K	1000	1000	1000	1000	1000	1000	1000
		S	1250	1250	1250	1250	1250	1250	1250
Mixing, vertical arrangement (in series)	XPIS	-	500	500	500	750	750	750	750
Mixing, vertical arrangement (in series)	XPID	-	750	750	750	1000	1000	1000	1000
Mixing, horizontal arrangement	XPBS	-	500	500	500	750	750	750	750
Mixing, horizontal arrangement	XPBD	-	750	750	750	1000	1000	1000	1000
Damper	LK	-	170	170	170	170	170	170	170
Elastic connection	DV	-	150	150	150	150	150	150	150
Closing panel	XPKO	-	25	25	25	25	25	25	25
Through section	XPJP	K	250	250	250	250	250	250	250
		S	500	500	500	500	500	500	500
		D	750	750	750	750	750	750	750
		E	1000	1000	1000	1000	1000	1000	1000
Service section (without tray)	XPJS..	K	250	250	250	250	250	250	250
		S	500	500	500	500	500	500	500
		D	750	750	750	750	750	750	750
Service section (with tray)	XPJS../V	S	500	500	500	500	500	500	500
		D	750	750	750	750	750	750	750
Corner section (input or output from above/below)	XPJR	-	500	500	750	750	750	750	750
Corner section (input or output from right/left side)	XPBR	-	750	750	750	1000	1000	1000	1000

\* Valid for fans with direct discharge

# UNIT DIMENSIONS

SEPARATE SECTIONS									
Function	Designation	Variant	Section length (mm)						
			XP 04	XP 06	XP 10	XP 13	XP 17	XP 22	XP 28
Plate heat exchanger – parallel branches	XPXB	-	1250	1500	1650	2000	2250	2250	2600
Plate heat exchanger – vertically arranged branches	XPXQ	-	1000	1200	1350	1560	1560	1840	1840
Rotary Heat Exchanger	XPKR	-	360	360	360	360	360	400	400
Steam humidifier	XPJZ	-	1250	1250	1250	1250	1250	1250	1250
Section with a built-in control unit	XPRJ	-	1000	1000	1000	1000	1000	1000	1000
Section with a frequency inverter	XPRF	-	1000	1000	1000	1000	1000	1000	1000

MULTISECTION									
FUNCTION	DESIGNATION	VARIANT	MULTISECTION LENGTH (MM)						
Bag filter + water heater	XPQC	D	750	750	750	750	70	750	750
Water heater + service 250 mm	XPQW	S	500	500	500	500	500	500	500
Water heater + service 500 mm	XPQW	D	750	750	750	750	750	750	750
Water heater + cooler + drop eliminator	XPQD	-	750	750	750	750	750	750	750
Cooler + drop eliminator	XPQU	-	500	500	500	500	500	500	500
Cooler + drop eliminator + service 250 mm	XPQY	-	750	750	750	750	750	750	750
Cooler + drop eliminator (with covered leads)	XPQR	-	750	750	750	750	750	750	750
Service 250 mm - insert filter	XPQH	S	500	500	500	500	500	500	500
Service 250 mm + frame filter	XPQH	S	500	500	500	500	500	500	500
Service 250 mm + bag, compact filter	XPQH	D	750	750	750	750	750	750	750
Service 250 mm + grease filter	XPQT	-	750	750	750	750	750	750	750

DUCT CONNECTION DIMENSIONS															
Unit size	Panel XPK Full cross-section		Panel XPK Internal damper		Panel XPK ADH/DRDH		Side panel External damper		Side panel Internal damper		Panel HD External damper		Panel HD Internal damper		Flange
	A (mm)	B (mm)	A (mm)	B (mm)	A (mm)	B (mm)	A (mm)	B (mm)	A (mm)	B (mm)	A (mm)	B (mm)	A (mm)	B (mm)	A (mm)
XP 04	500	450	350	400	330	330	350	350	350	250	450	350	350	350	20
XP 06	650	600	500	550	370	370	350	500	350	400	600	350	500	350	20
XP 10	810	760	660	710	510	510	350	660	350	560	760	350	660	350	20
XP 13	915	865	765	815	570	570	450	765	450	665	865	450	765	450	30
XP 17	1220	865	1070	815	640	640	450	765	450	665	1170	450	1070	450	30
XP 22	1220	1170	1070	1120	780	780	550	1070	550	970	1170	550	1070	550	30
XP 28	1525	1170	1375	1120	800	800	550	1070	550	970	1475	550	1375	550	30

AIR FLOW RATE						
Unit size	Airflow rate (m³/h) at speed m/s					
	1,5	2	2,5	3	3,5	4
XP 04	1500	2000	2500	2950	3450	3950
XP 06	2450	3300	4100	4900	5750	6550
XP 10	3750	5000	6250	7500	8800	10050
XP 13	4750	6350	7950	9550	11150	12700
XP 17	6300	8350	10450	12550	14650	16750
XP 22	8350	11150	13950	16750	19500	22300
XP 28	10400	13850	17300	20750	24200	27650

MULTISECTION – CROSS-SECTION								
Unit size		04	06	10	13	17	22	28
External cross-section (mm)	A	650	800	960	1065	1370	1370	1675
	B	600	750	910	1015	1015	1320	1320
Internal cross-section (mm)	A1	550	700	860	965	1270	1270	1575
	B1	500	650	810	915	915	1220	1220

### EXAMPLE OF XP ASSEMBLY WITH FILTRATION

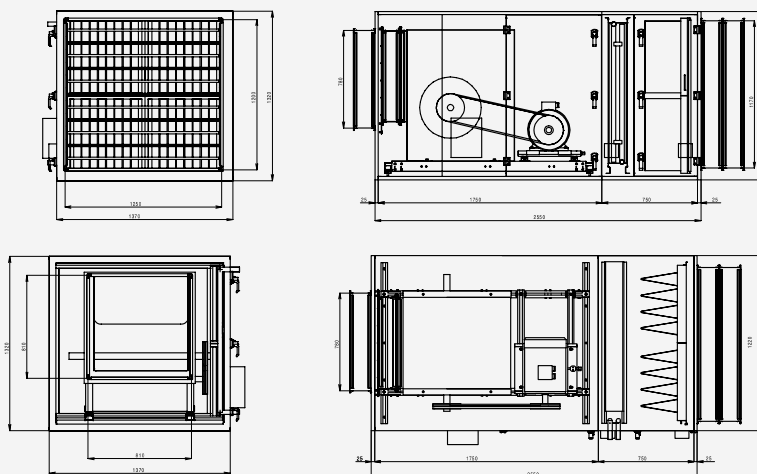

# OUTDOOR VERSION OF UNITS

## CHARACTERISTICS

An outdoor Aeromaster XP air-handling unit, which complies with European standards applicable for these applications, can be designed by selecting suitable sections, materials and accessories. The component list below will allow you to create an AeroMaster XP air-handling unit suitable for the outdoor environment using our unique AeroCAD design system.

## CASING MECHANICAL PERFORMANCE

As standard, outdoor air-handling units can be delivered with the same variants of the casing as for indoor applications. However, it is always advisable to use the external casing made of painted sheet steel (RAL9002) with corrosion resistance for C3 environments classes in accordance with EN ISO 14713 (standard) or powder-painted sheet steel for C4 highly aggressive environment classes in accordance with EN ISO 14713 (on special demand).

## SPECIAL SECTIONS

**The following sections have been developed for outdoor versions:**

- XPTP and XPQR exchanger sections enabling feed covering
- XPTG gas heater section with a burner cover
- XPIS, XPID, XPBS, XPBD, XPJR, XPBR, XPJS, XPQH, XPQT sections enabling inner pocket installation
- XPJP, XPJS, XPQH and XPQT sections on the air-handling unit intake with increased anti-corrosion protection which is ensured by the stainless internal casing and condensate drainage tray



# OUTDOOR VERSION OF UNITS

## OUTDOOR UNIT ACCESSORIES

### Roof, optional:

- galvanized sheet steel EN 10 346 Z275 g/m<sup>2</sup>, corrosion resistance for C2 environment class as per EN ISO 14713
- galvanized sheet steel - continuous hot-dip galvanized EN 10 346 Z275 g/m<sup>2</sup> + 25 µm polyester paint, RAL 9002 EN10169 (corrosion resistance RC3), C2 environment class as per EN ISO 14713.

### Louvers:

- powder painted sheet steel – continuous hot-dip galvanizing EN 10 346 Z275 g/m<sup>2</sup> + 60 µm paint (outer side), RAL 9002, corrosion resistance for C4 environment class as per EN ISO 14713.

### Inlet/outlet adaptor:

- powder painted sheet steel – continuous hot-dip galvanizing EN 10 346 Z275 g/m<sup>2</sup> + 60 µm paint (outer side), RAL 9002, corrosion resistance for C4 environment class as per EN ISO 14713.

## AN EXAMPLE OF THE AIR-HANDLING UNIT DESIGNED FOR THE OUTDOOR ENVIRONMENT

- ❶ XPZO louvers
- ❷ Service section, XPQH 13/N filter (in internal casing version)
- ❸ XPPO 13 attenuator section
- ❹ XPTP 13/S Water heater section with covered feeds
- ❺ XPTP 13/F CHF cooling section with covered feeds
- ❻ XPAP 13/D fan section
- ❼ XPPO 13 attenuator section
- ❽ XPSO roof

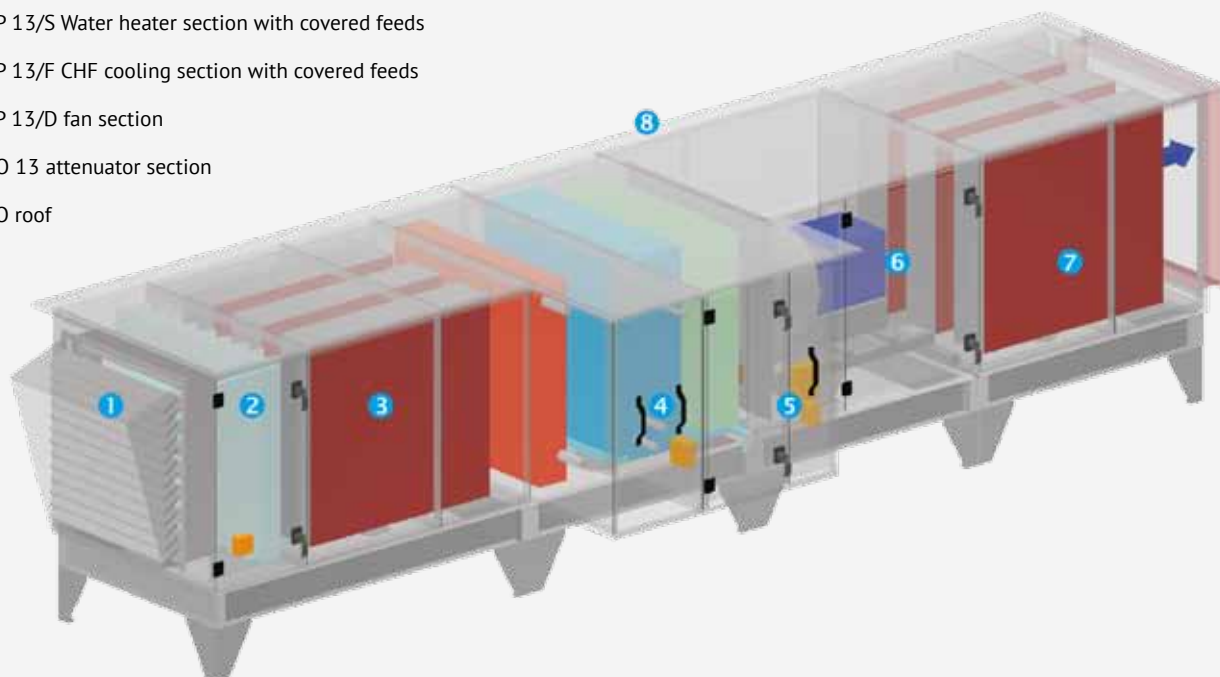

# UNITS FOR EXPLOSIVE ENVIRONMENTS

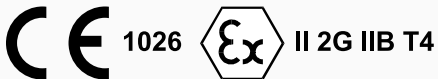

## UNITS FOR EXPLOSION AREAS

These AeroMaster XP air-handling units meet the ATEX 100 Directive (European Parliament and Council Directive 94/9/ES) and can be delivered in both outdoor and indoor versions. Each unit in the ATEX version will be designed and calculated individually in accordance with the needs of the specific application.

A separate Conformity Certificate will be issued for each unit. The units in the ATEX version are checked and tested for safety by the independent Notified Body 1026/ AO 210 - FTZÚ Ostrava Radvanice. Each piece of equipment must be labelled in accordance with the specific explosive area of application.

Classification of AeroMaster XP Air-Handling Units for Explosive Environments:

- The unit meets ATEX 100 (European Parliament and Council Directive 94/9/EC)
- FTZÚ Conformity Certificate
- Zone 1
- Equipment group (area of application)
- Category 2
- Gas explosive atmosphere G
- Explosive gas group IIB
- Heat class T4

Some differences between ATEX and standard versions:

- All the parts have a metal connection or contact to the central grounding point.
- The fan motors and impellers are type tested and certified in accordance with the ATEX Directive.
- Air filters are made of antistatic materials.
- Special bearings are used.
- Special grounding, conductive bridging and special grommets are used.
- The units are manufactured with higher casing air leakage L1 in accordance with ČSN EN 1886/2008.
- Special chemical composition of internal aluminium assemblies.
- All the internal assemblies are certified by the Notified Bodies for the whole EU area.



# IMPROVED AIR LEAKAGE (L1)

## CASING AIR LEAKAGE L1

The AeroMaster XP air-handling units in L1 version comply with the EN 1886 requirements for casing air leakage.

Compared to the standard AeroMaster XP design, the L1 version differs in the following details:

- New attachment of the fixed panels
- New sealing under the fixed panels
- New service panel design
- Original passing closures (handles) have been replaced with new non-passing closures.
- New non-stick all-round profile sealing in accordance with the DIN 1946-4 requirements
- New design of the wires leading through the panel
- The sections are connected using only internal connecting elements (in corners and in the centre)

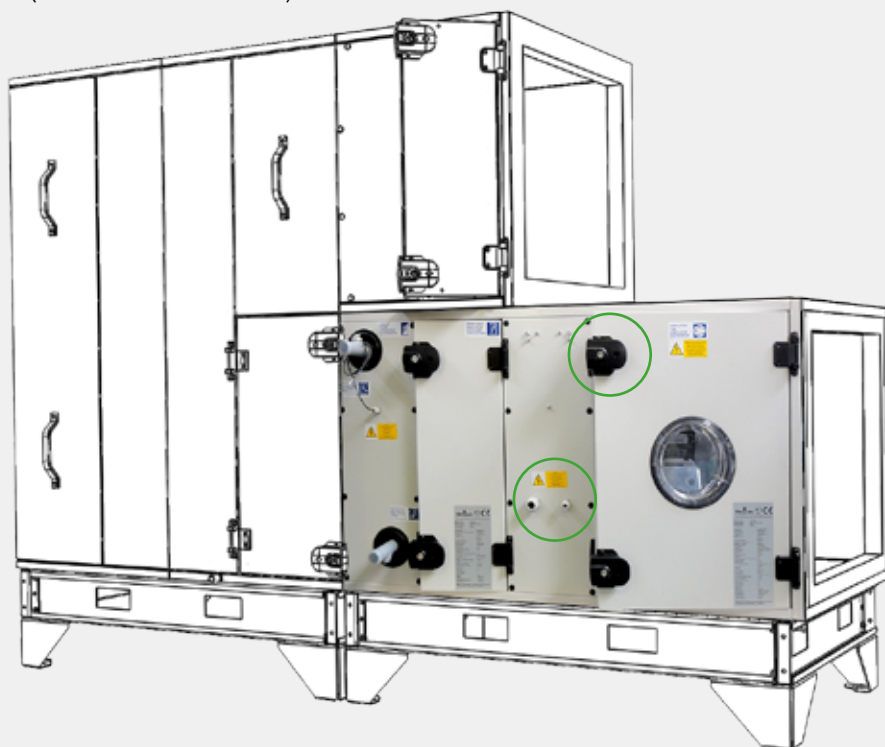

# COMPREHENSIVE SOLUTION



Control unit section

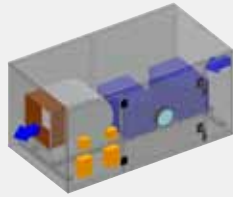

Automated backup

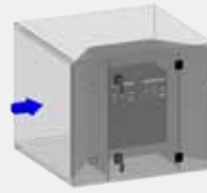

Frequency inverter section

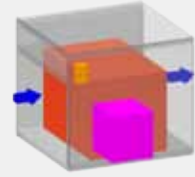

Gas heater section including bypass

## Thanks to new components, you can significantly shorten the unit length

Original version, 580 cm

New version, 389 cm, shorter by 191 cm

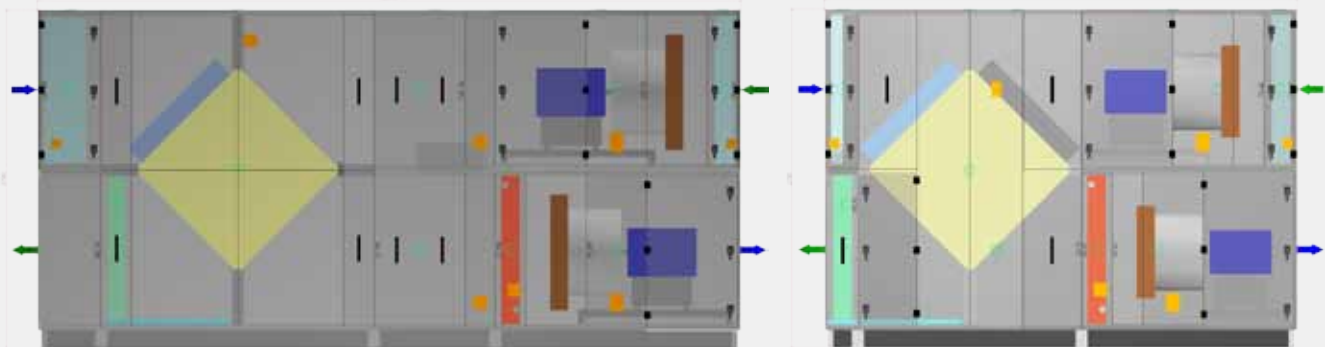

Here it is a list of effective length savings resulting from the example above

- Shorter G4 filter (-250 mm)
- Shorter plate heat exchanger (-410 mm)
- Mixing integrated into the plate heat exchanger (-1000 mm)
- Shorter fan sections used (-250 mm)

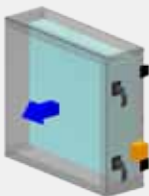

New G4 frame filter section



Compact mixing sets

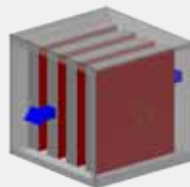

Attenuator section



Detail of section connection



New integrated cooling section



## EASY-TO-GET OFFER

## YOU HAVE A CLEAR REQUIREMENT...

## Contact us:

- Tel: 00420 571 877 778
- Fax: 00420 571 877 777
- E-mail: [export@remak.cz](mailto:export@remak.cz)



## DO YOU WISH TO CONSULT YOUR DESIGN WITH US?

- Contact your personal consultant in REMAK – [www.remak.cz](http://www.remak.cz)
- We will design your unit together in your office.

... PROMPT DESIGN DURING PERSONAL MEETING



## DO YOU WANT THE UNIT TO BE MADE-TO-MEASURE?

- Order your AeroCAD Professional design program.
- Register as an AeroCAD Professional program user.
- Create required unit, and send it to the following address: [aerocad@remak.cz](mailto:aerocad@remak.cz)

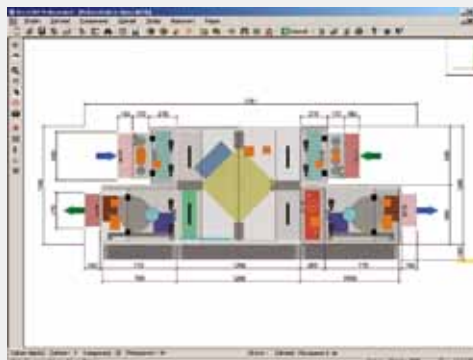
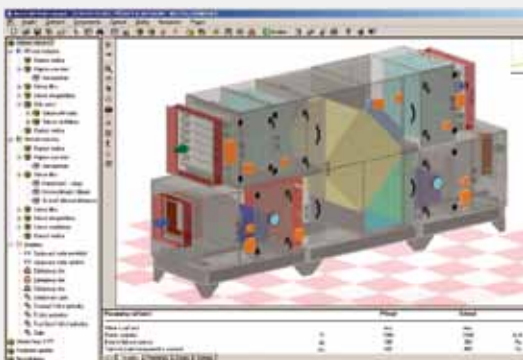

## ...IMMEDIATELY AVAILABLE TECHNICAL PARAMETERS AND THE PRICE BY RETURN

# MOLLIER H-X CHART

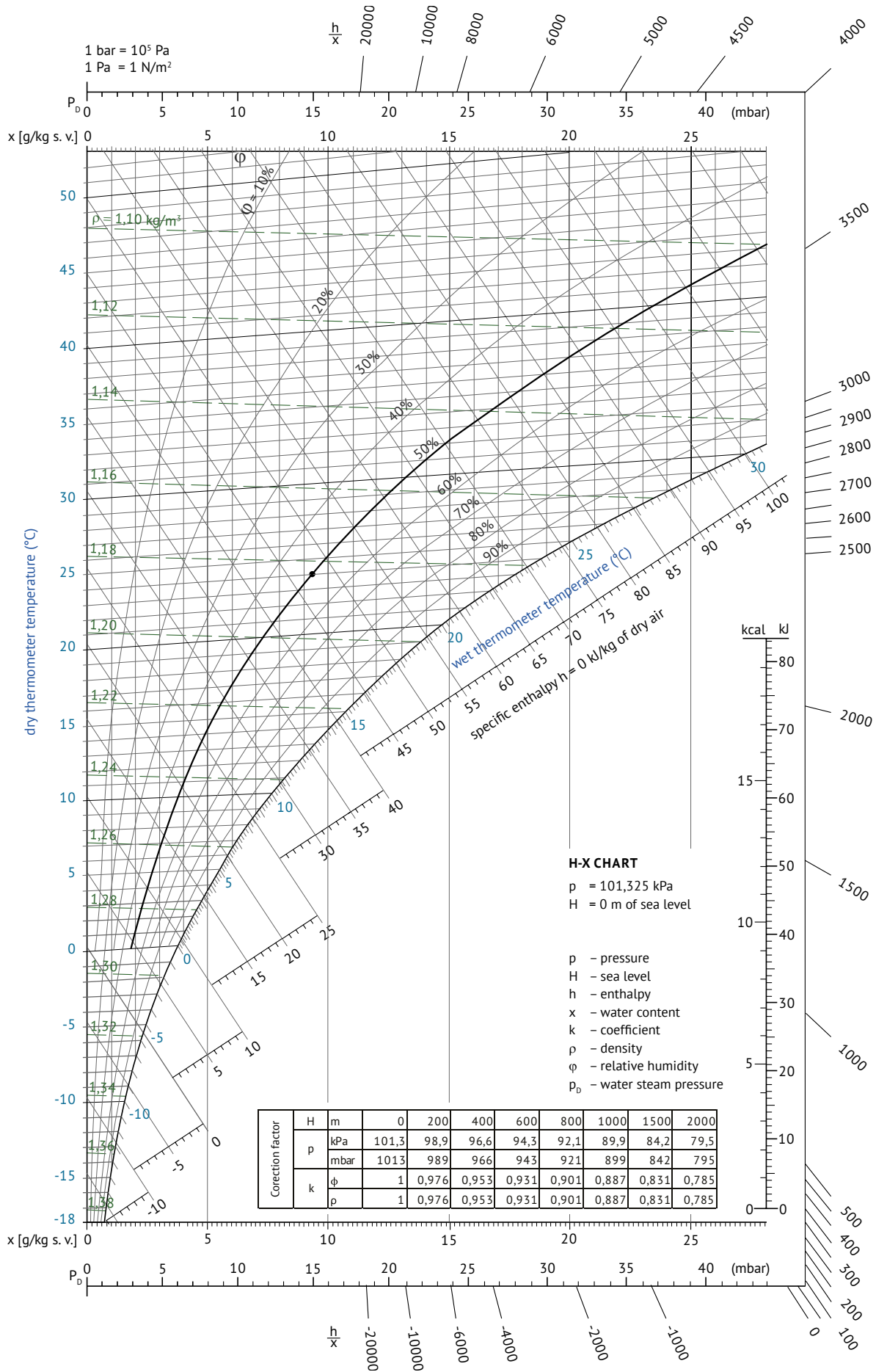



This Catalogue (as a whole or a part) must not be printed or copied without prior written permission from REMAK a. s., Zuberská 2601, Rožnov pod Radhoštěm, Czech Republic.

This „Catalogue“ are the sole property of REMAK a. s.

Changes reserved.

Issued: 26<sup>th</sup> March, 2013

Technical data updated on 26<sup>th</sup> March, 2013. Printing and language mistakes are reserved.





REMAK a. s.  
Zuberská 2601  
756 61 Rožnov pod Radhoštěm  
Česká republika  
tel.: +420 571 877 778  
fax: +420 571 877 777  
[www.remak.eu](http://www.remak.eu)

