

## *Air handling units*

**AeroMaster**  
**FP**

## Content

<b>Application, working conditions, construction .....</b>	<b>3</b>
Information from the producer.....	3
Application and working conditions .....	3
Construction of air handling unit.....	3
Unit labelling.....	3
Informative and safety labels .....	3
Service access to units.....	3
<b>Expedition .....</b>	<b>4</b>
List of requirements for expedition .....	4
Transport and handling of parts .....	4
Storing.....	4
<b>Installation.....</b>	<b>5</b>
Placing.....	4
Check before installation.....	5
Identification of unit parts .....	5
Connection of unit sections .....	5
<b>Connection of exchangers .....</b>	<b>6</b>
Connection of exchangers .....	6
Water exchangers.....	6
Connection dimensions of water exchangers.....	6
Direct evaporators.....	6
Connection dimensions of direct evaporators .....	6
<b>Other connections .....</b>	<b>7</b>
Condensate outlet.....	7
Connection of air handling duct.....	7
Connection of electric devices .....	7
Connection of motors .....	7
Schemes of electric wiring.....	8
<b>Preparation for start-up, start of operation.....</b>	<b>10</b>
Check before first start-up of unit .....	10
Putting device in operation .....	10
Check during first start-up of unit .....	10
<b>Operation checks, operation regulations.....</b>	<b>11</b>
Unit operation – operation regulations .....	11
Regular operation checks .....	11
Regular inspections.....	11
<b>Spare parts, service .....</b>	<b>13</b>
Spare parts.....	13
Service.....	13
Disposal and recycling .....	13

## Application, working conditions, construction

### Information from the producer

AeroMaster FP air-handling units are produced according to valid czech and european technical regulations and technical standards. Units can only be installed and used according to this documentation. Installation and service instructions must be accessible to service attendance and therefore it is useful to place it close to the unit.

### Application and working conditions

AeroMaster FP air-handling units are intended for comfortable air-handling and air-conditioning of smaller rooms. They are manufactured in two dimensional ranges, FP 2.7 and FP 4.0, for air flow ranges from 500 m<sup>3</sup>/h to 4,500 m<sup>3</sup>/h at air pressure deference of the fan of up to 1200 Pa. AeroMaster FP air-handling units are designed to transport air without solid, fibrous, sticky, aggressive, respectively explosive impurities. The transported air must be free of corrosive chemicals or chemicals aggressive to zinc and steel, respectively aluminium. When designing the air-handling assembly, it is necessary to take into account the temperature and humidity of the inlet and outlet air in relation to the ambient temperature and humidity. It is especially necessary to analyze the relation of the unit's casing classification pursuant to EN 1886 and the risk of condensation respectively, ice build-up. AeroMaster FP air-handling units can be used in normal rooms (IEC 60364-5-51, resp. ČSN 332000-5-51 ed.2, ČSN 332000-1 ed.2) and in rooms with extended ambient temperature range ranging from -30 °C to +40 °C without additional measures. Degree of protection - IP 40. The unit's accessories (M&C) are not included - they must be assessed separately.

### Construction of air handling unit

Unit construction is sectional, modular. Casing is composed of panels and connecting bars between them. Panels are attached to connecting bars and by threaded joints between each other. For cases of regular maintenance or inside checks (change of filtration

inserts, cleaning etc.), the sections are equipped with service panels which have the same construction as stationary panels but they are equipped with handles and fixed by turning thrust latches.

All panels have sandwich construction with total width of lateral insulation of 40 mm, upper and bottom of 25 mm with quality anticorrosive treatment. Panels are provided with PE seal stuck to panel surfaces of contact. Complete air handling unit Viking FP is composed of sections. The sections are (mechanically) separate while the lateral panel of the section is compact (panel without bars). The section is functionally defined by a cassette.

### Unit labelling

Every section (except the frame) is provided with type (production) label of section, with following data:

- producer name
- type, size and code identification of the section
- order number /year of production
- weight
- wiring (electric system)
- electric protection

The label also includes technical parameters of given section. The user must make sure, that all labels on the machine are readable and undamaged during whole operation time. In case of damage of label concerning safe use, repair it at once.

### Informative and safety labels

FP units and separate sections are further provided with informative labels showing the function of the device, wiring schemes, media inlets and outlets and producer labelling.



Warning symbol „Other danger“ is placed on the outside of the unit on the service door and it calls attention to hazard of interception with moving objects.



Service panel of electric heating section, separate wiring boxes and service panels covering electric devices are provided with label with warning symbol meaning „Warning – Danger of Electric Shock“

**Picture 1** – service access to units (left/right)

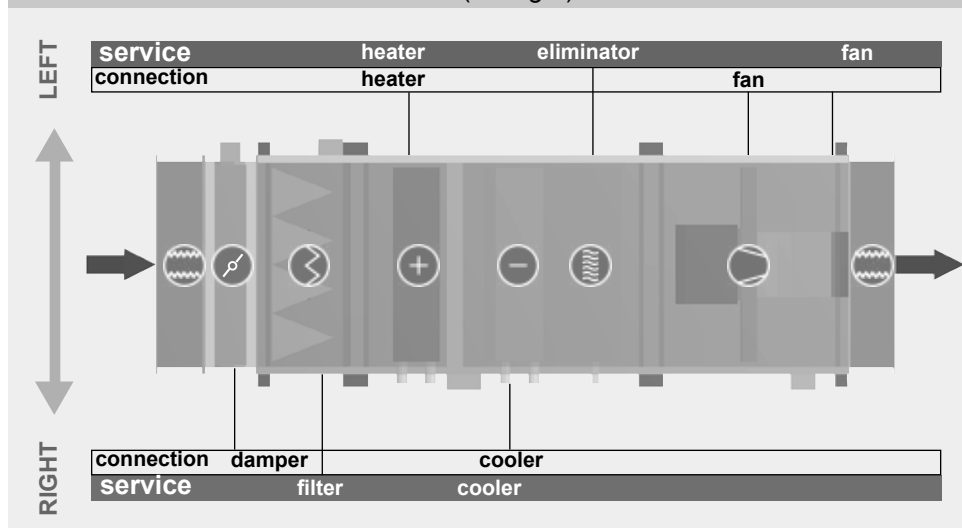

### Service access to units

Unit construction provides combinations of sides of energy connection and service accesses. Connection side is always given according to the direction of air flow. (picture 1)

### Meaning of symbols

- elastic connection
- air damper
- air filter
- heater
- cooler
- drop eliminator
- fan

## Expedition

### List of requirements for expedition

To every air handling FP unit belong:

- Accompanying technical documentation.
- Trade technical documentation with scheme of unit FP installation.
- Device service book.
- Connecting kit
- Mounting kit
- Separate elements of measuring and regulation, or accessories according to the bill of delivery

### Transport and handling of parts

FP units are delivered to customers (to place of installation) as separate blocks according to suggestion in the project. Blocks are set on transport palletes of appropriate dimensions and secured from moving by belting. Loading or unloading is done by forklift truck or by hand pallet truck.

The forks of the forklift truck must be set so, that they reached over the whole length of section and so that it was forked for the whole length.

During transportation or handling it is necessary to pay attention to elements sticking out of sides of section (pipes, wiring elements, sensors, motor spindles).

It's necessary to be especially careful when lifting it up and putting it down.

### Storing

Storing means storage of wrapped units delivered by producer for period longer then 30 days.

Units are placed on transport pallets, wrapped in PE foil and protected by polystyrene protections.

They must be stored at places where:

- maximal relative air humidity doesn't exceed 85% and without humidity condensation
- surrounding temperature ranges from -20°C up to +40°C
- no dust, gasses and corrosive fumes or other chemical matters causing corrosion of constructional parts and device equipment may get into the device.

### Placing

FP units are standardly installed in horizontal suspended position - under the ceiling.

The units can also be installed in lying horizontal position (on prepared basement).

Picture 3 – installation on a basement (floor)

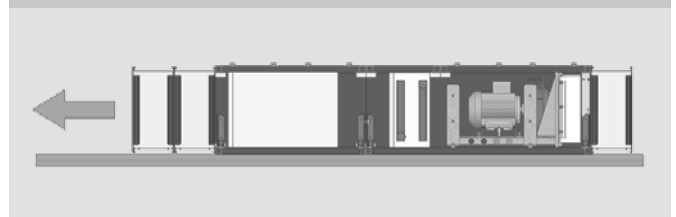

Units with cooling or heat recovery can not be installed in horizontal position on the floor.

Unit installation in vertical position requires producing of special frame (which is not part of delivery). Separate sections are attached to this frame using clips.

When choosing place for installation it is necessary to follow these requirements:

- sufficient space for connection of needed installation
- sufficient space for right installation of unit
- sufficient space for attendance and service of unit, change of separate parts in case of failure.

Distances between surrounding parts and air handling unit result from inside dimensions of cassettes and from elements of connecting fittings. Recommended distances can be visualized in program AeroCAD. Side distance should not be smaller then 400 mm.

Picture 2 – suspension under the ceiling

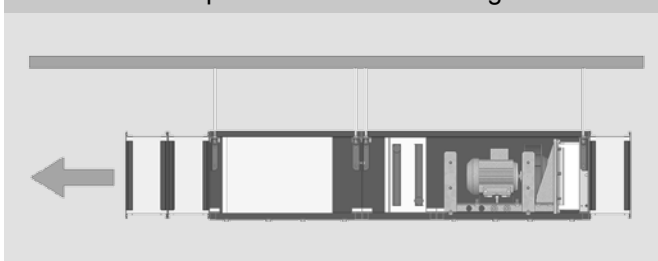

## Installation

### Check before installation

Before the actual installation, according to technical description, tables of description or production labels and technical documentation are usually done these checks:

- entirety of delivery
  - condition of delivery
  - versatility of rotary elements, fan section, dampers
  - check of voltage system parameters
  - check of temperature and pressure of connected supplies according to unit parameters specification
- In case of inconsistency concerning installation and above mentioned actions, it's necessary to contact service technicians of Remak a.s., tel.: 00420 571 877 736 or by e-mail: hot.line@remak.cz.

### Identification of unit parts

On production labels of every section there is marked applicability to order number that means number of device and position number of section. First two digits mark applicability to certain device of given order. Second two digits mark position of the section in device. All sections with the same device number compose a air handling unit.

Accompanying technical documentation created using the AeroCAD design program, which includes drawings of the air-handling unit assembly, a list of individual components (sections, section assemblies) including their parameters, respectively the control unit wiring diagram, is included in the delivery. This documentation uniquely defines the position of individual components within the assembly. Each component of the air-handling unit in the documentation is marked with a position number.

**Picture 4 - identification of unit parts**

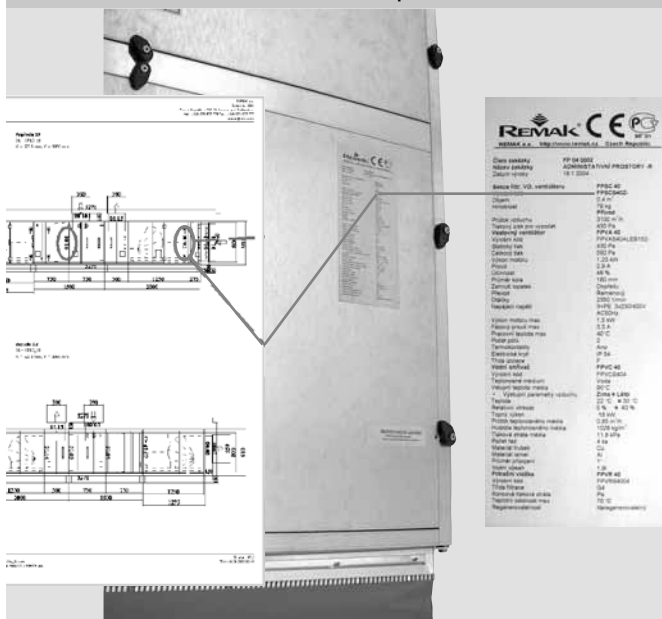

With this position number corresponds in the list of components a device with certain type and code identification. This type identification along with code is shown on component production label.

This bond enables fast and exact orientation when putting unit together and easy check of correctness and entirety of installation.

### Connection of unit sections

Connection of separate sections of a unit is done by bolt fastening. Bolts are part of delivery. Before fastening of separate section together, there must be rubber sealing stuck to surfaces of contact.

**Warning:** The producer recommends to insert between unit and area of unit installation (wall) a standard elastic element (elastic plastic absorber).

For safety reasons are service panels covering fan and electric heater cassette equipped with additional mechanical protection.

- When removing the panel it's necessary to loosen the bolts of shutters in opposite corners and then it's possible to twist off the shutter.
- Both shutters are labelled with informative label "Safety shutter".
- Procedure of panel installation is inversed.
- It is prohibited to remove panel of alive electric heater and change setting of safety thermostat set by producer!

**Picture 5 – connection of sections**

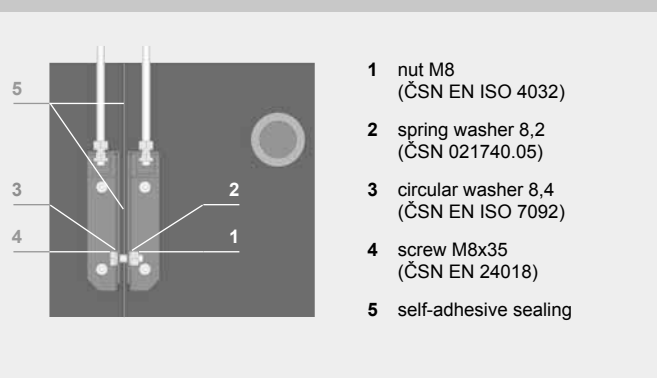

**Picture 6 – service accesses**

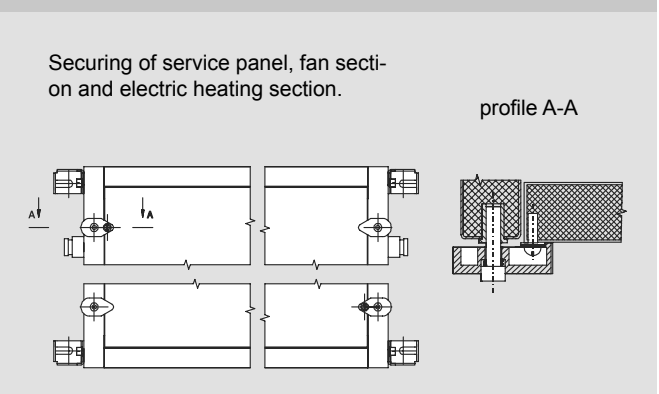

## Connection of exchangers

Picture 7 – energy supply

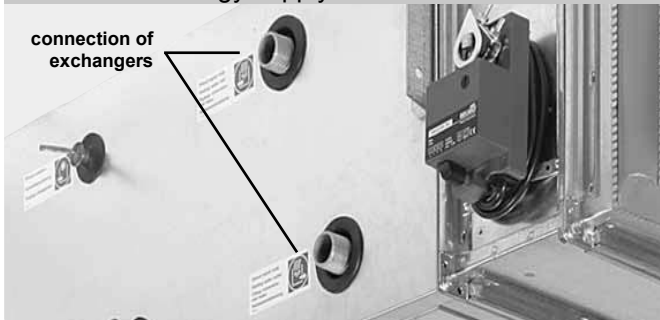

### Connection of exchangers

When connecting heating or cooling supplies the forces originating at fitting dilatation and its weights may not be transmitted to the unit. Appropriate places of connection are marked on panels of section (heating water inlet (outlet), coolant inlet (outlet), condensate outlet).

To reach maximal output it is necessary to connect the exchangers in the counterflow direction. When connecting the fittings to the exchangers it is necessary to use two wrenches during the drawing close to prevent twisting off of the connection of the exchanger collectors.

**Warning:** After connection of water exchangers (heaters and coolers, including mixing sets) to the system it's necessary to do aeration (irrigation) and deaeration of the whole circuit, including exchangers and check tightness of pipe connections and of the exchanger itself (including inspection of section with water exchanger). Producer of unit does not take over guarantees for damages caused by fluid leak from connections or by damaged exchanger.

### Water exchangers

As standard, the water heat exchangers are equipped with automatic Taco 1/2" air-venting valves, which are situated on the upper parts of both headers.

Picture 8 – connection of exchangers

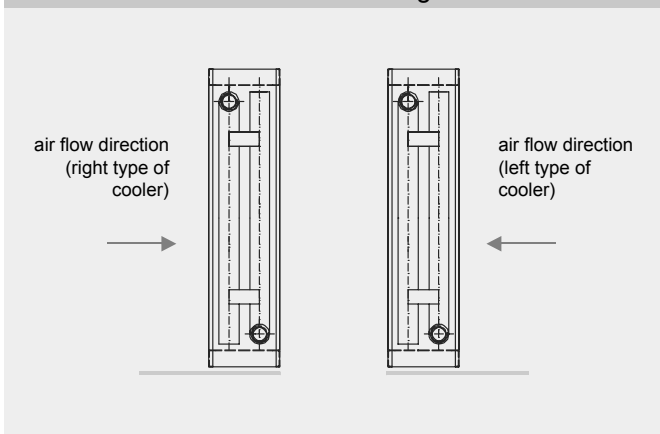
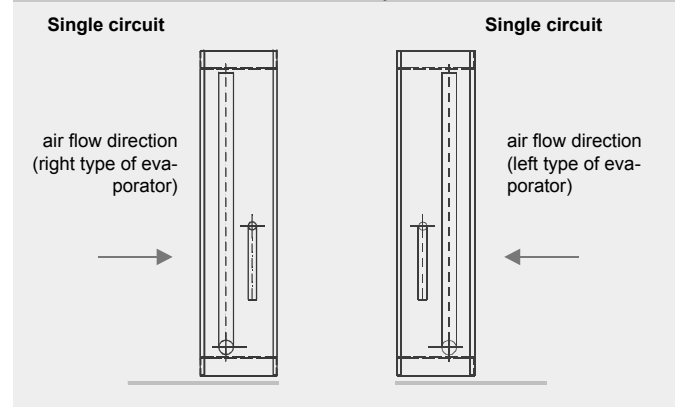

Table 1 – connection dimensions of water exchangers

Size of unit	Connection
FP 2.7	G 1"
FP 4.0	G 1"

## Direct evaporators

Picture 9 – connection of evaporators



### Connection dimensions of direct evaporators

Table 2 – external connection dimensions of direct evaporators in mm

Direct evaporators		Connection	
Size	# of rows	Inlet	Outlet
FP 2.7	2	16	22
	3	16	22
	4	16	22
	5	22	28
	6	22	28
FP 4.0	2	16	22
	3	16	22
	4	16	22
	5	22	28
	6	22	28

### Steam humidification

For a detailed description of installation, commissioning and prescribed inspections of the steam humidification section, refer to the separate manual which is a part of the accompanying documentation of the FP air-handling unit. When installing the steam humidification section, observe the following recommendations:

- Air ducts leading through cold areas must be insulated to avoid condensation.
- The steam generator can be noisy (switching of solenoid valves); therefore, it is advisable to install it away from quiet areas.
- **100°C heavily mineralized water is drained from the steam humidifier.**
- **The following minimum distances (distances between the steam tube and the following air-handling unit components, where H represents the minimum evaporating distance calculated for the given conditions) must be observed to ensure proper operation of the steam humidifier:**
  - Humidistat piping and sensor, temp. sensor: 5x H
  - Very fine filter: 2,5x H
  - Heating elements, filter: 1,5x H
  - Duct branch piece, duct elbow, air outlet, fan: 1x H

**Other connections**

**Condensate outlet**

Cooling, plate heat exchanger and steam humidification sections are equipped with stainless condensate draining trays which terminate in an outlet for the condensate draining kit connection. This outlet is provided with a G1/2" thread. The condensate draining kits are available as extra ordered optional accessories. A separate condensate draining kit must be used for each section. The siphon height depends on the total pressure of the fan, and its proper height is essential for good

**Picture 10 – condensate outlet**

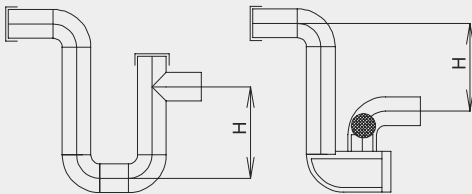

**Table 3 – dimensions of seal-pipes**

Total pressure of fan (Pa)	Height H (mm)
<600	60
600-1000	100
1000-1400	140

H...total height of seal-pipe

functioning. The type of condensate draining kit must be designed in the course of the air-handling unit calculation.

Before the first start-up and after longer shut-down the seal-pipe must be filled with water through the plastic plug. The unit can also be equipped with seal-pipe with a stink trap and spherical valve (only for sections with underpressure). This type of seal-pipe doesn't have to be filled with water before start-up.

**Duct connection**

Connection of the air handling duct must be done using elastic connection, which prevents the vibrations from transferring and enables the duct to be connected to the unit even if those two components are not co-axial. This connection should be done in such way that the duct didn't deform and burden the inlet opening of unit. Accessories are mounted according to unit specification and according to installation instructions of accessory producer.

**Picture 11 – duct connection**

Elastic connection DV



**Connection of electric devices**

The wiring and installation of the M&C system elements must be performed by qualified professionals authorized to perform wiring of the given type of device in accordance with national standards and regulations applicable in the country of installation as well as the Installation and Operating Instructions applicable for individual components (frequency converters, pressure and temperature sensors, etc). Before the start up, the check of electric device must be performed. Before the start check:

- conformity of voltage, frequency and protection with data on the label of the section
- connecting cables of sections

**Picture 12 – unit production label**

**REMAK** **CE** **PC**  
REMAK a.s. <http://www.remak.cz> Czech Republic

Číslo zakázky Název zakázky Datum výroby	FP 04 0001 ADMINISTRATIVNÍ PROSTORY -R 18.1.2004
Sekce FILTR, EO Výrobní kód Objem Hmotnost	FPSO 27 FPSOS27ZL 0,8 m <sup>3</sup> 52 kg
průtok vzduchu Tlakový ztráta Elektrický ohřivač	Přívod 1500m <sup>3</sup> /h 25 Pa FPVE 27 X
Výrobní kód • Výstupní parametry vzduchu	FPVES2712X Zima = Léto
Teplota Relativní vlhkost	22 °C = 24 °C 5% = 40 %
Topný výkon Napájecí napětí	12 kW 3N+PE 3x230/400V AC50Hz
Fázový proud Topné tyče	18 A 12ks x 1kW
Výkon sekci Typ splnění Elektrické krytí Pracovní teplota max.	6+6kW EOSX IP 54 40 °C

type

output power

According to type and output power of electric heater on label of heater section, assign appropriate scheme.

## Other connections

### Schemes of electric wiring - motors of fans

#### 2 Triple-phase motors (2x, up-to 1,1 kW)

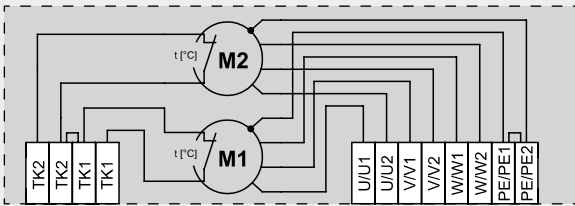

**TK1, TK1**

- clamps of the 1st motor thermocontacts

**TK2, TK2**

- clamps of the 2nd motor thermocontacts

**U1, V1, W1, PE1**

- power supply clamps of the 1st triple-phase single speed motor 3ph.-400V/50Hz

**U2, V2, W2, PE2**

- power supply clamps of the 2nd triple-phase single speed motor 3ph.-400V/50Hz

#### 2 Triple-phase motors (2x, up-to 1,1 kW)

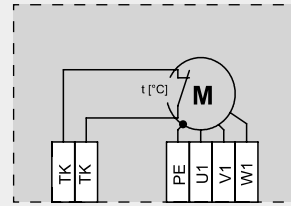

**U1,V1,W1,PE**

- clamps of triple-phase motor power supply. 3ph.-400V/50Hz

**TK,TK**

- clamps of motor thermocontacts

#### Single phase motor (up-to 0,5 kW)

controlled by single-phase frequency inverter (up to 0,5 kW), Modbus

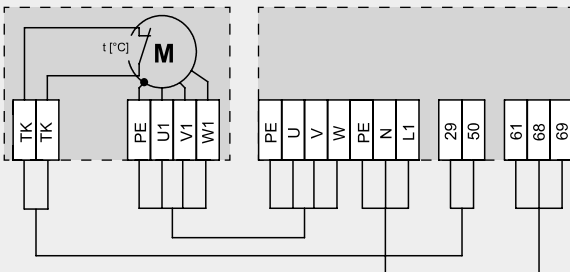

Frequency inverter power supply Modbus

**U1, V1, W1, PE1**

- power supply clamps of triple-phase single speed motor 3ph.-400V/50Hz

**TK, TK**

- clamps of the motor thermocontacts

**L1, N, PE**

- clamps of single-phase frequency inverter power supply 1ph.-230/50Hz

**29, 50**

- frequency inverter terminals for the motor's thermo-contact (TK) connection

**61, 68, 69**

- Modbus bus terminals

*Frequency converter data settings have been set by the manufacturer*

#### Single phase motor (1,5 kW)

controlled by three-phase frequency inverter, IP21 (1,5 kW), Modbus

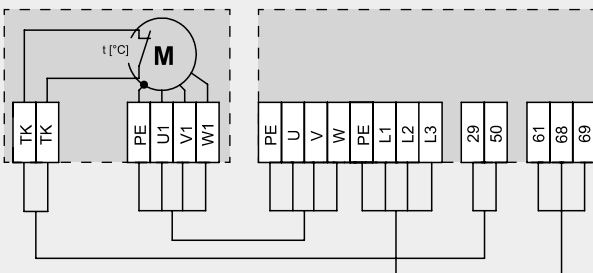

Frequency inverter power supply Modbus

**U1, V1, W1, PE1**

- power supply clamps of the triple-phase single speed motor 3ph.-400V/50Hz

**TK, TK**

- clamps of the 1st motor thermocontacts

**TK2, TK2**

- clamps of the 2nd motor thermocontacts

**L1, L2, L3, PE**

- clamps of three-phase frequency inverter power supply 3ph.-400V/50Hz

**29, 50**

- TK clamps of frequency inverter

**61, 68, 69**

- Modbus bus terminals

*Frequency converter data settings have been set by the manufacturer*

#### Single phase motor (up-to 2x 1,1 kW)

controlled by three-phase frequency inverter, IP21/IP54 (up to 2,2 kW), Modbus

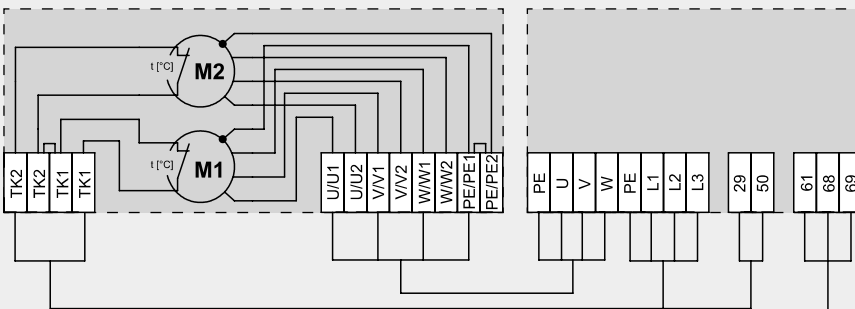

Frequency inverter power supply Modbus

**U1, V1, W1, PE1**

- power supply clamps of the 1st triple-phase single speed motor 3ph.-400V/50Hz

**U2, V2, W2, PE2**

- power supply clamps of the 2nd triple-phase single speed motor 3ph.-400V/50Hz

**TK1, TK1**

- clamps of the 1st motor thermocontacts

**TK2, TK2**

- clamps of the 2nd motor thermocontacts

**L1, L2, L3, PE**

- clamps of triple-phase frequency inverter power supply 3ph.-400V/50Hz

**29, 50**

- TK1 (1st motor) clamps and TK2 (2nd motor) clamps of frequency inverter

**61, 68, 69**

- Modbus bus terminals

*Frequency converter data settings have been set by the manufacturer*



**Other connections**

**Schemes of electric wiring - electric heaters**

**EI. heater type FPVE ../.**

P= 6–31,5 kW

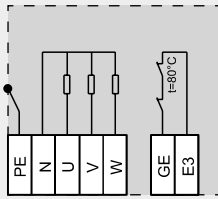

- U, V, W, PE, N**  
- clamps of electric heater power supply. 3f-400V/50Hz
- E3, GE**  
- clamps of safety thermostat

**EI. heater type FPVE ../.S**

P= 6–31,5 kW

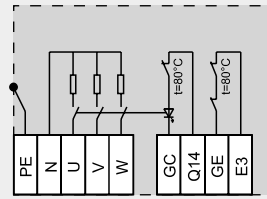

- U, V, W, PE, N**  
- clamps of electric heater power supply. 3f-400V/50Hz
- E3, GE**  
- clamps of safety thermostat
- Q14, GC**  
- clamps of electric heater switching 24V DC

**EI. heater type FPVE ../.X**

P= 12–18 kW

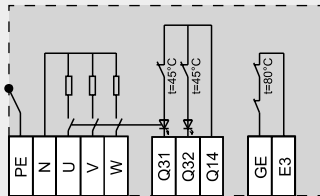

- U, V, W, PE, N**  
- clamps of electric heater power supply. 3f-400V/50Hz
- E3, GE**  
- clamps of safety thermostat
- Q31, Q32, Q14**  
- clamps of electric heater cascade switching 24V DC

**EI. heater type FPVE ../.X**

P= 22,5–31,5 kW

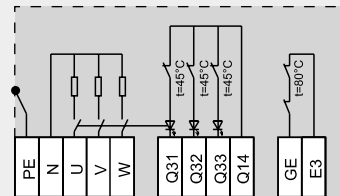

- U, V, W, PE, N**  
- clamps of electric heater power supply. 3f-400V/50Hz
- E3, GE**  
- clamps of safety thermostat
- Q31, Q32, Q33, Q14**  
- clamps of electric heater cascade switching 24V DC

**Connection of motors**

Motors are equipped with protecting thermocontacts which protect the motor from overheating. Thermocontacts must be connected according to specified connection.

Single-speed motors are designed for 230V D/400V Y power supply voltages and connections for electro motors with output up to 3kW.

Motors are in production wired to wiring box on casing of fan section. They are standardly intended for voltage 3x 400 V / 50 Hz.

If the delivery contains frequency inverter for control of motors with output up to 1,5 kW, the electric connection is then 1x 230 V / 50 Hz.

The same frequency inverter connection applies for control of two motors up to 0.75 kW (including). The frequency inverter connection for control of two 1.1 kW motors is 3x 400V/50 Hz.

If the single-speed motor is additionally connected to an output controller (frequency inverter), it is necessary to check, respectively reconnect the motor wiring (correct connection Y/D in the motor terminal box) in relation to the power supply voltage (230/400V).

**Picture 13 – Drive unit with two motors**

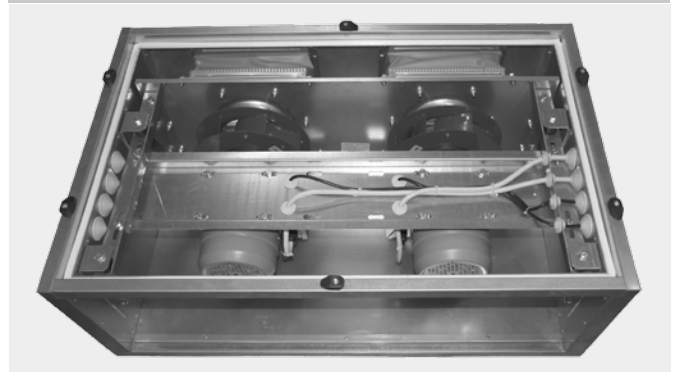

**Picture 14 – Connection terminal box**

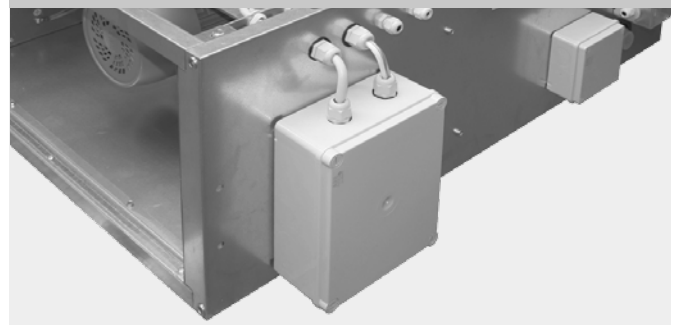

## Preparation for start-up, start of operation

### Check before first start-up of unit

#### General functions and check

- whether all components of air handling device are in place and properly connected
- whether the cooling and heating circuits are connected and whether the supplies are accessible
- whether all electric appliances are accessible
- whether all condensate drain kits are installed
- whether all elements of measuring and control are installed

#### Electric installation

- according to schemes of wiring check whether all electric elements of unit are correctly connected

#### Fan section

- check the fan impeller for intactness and free rotation.
- check the tightening of the Taper-Lock collets.
- check the tightening of the screw joints of the fan assembly.

#### Filter section

- state of filters
- attachment of filters
- setting of pressure difference sensors

#### Water heater section

- state of heat transmission surface
- state of inlet and outlet duct connection
- state and connection of mixing set
- state, wiring and installation of elements of anti-freeze protection

#### Electric heater section

- state of heating coils
- connection of heating coils
- connection of safety and operating thermostats

#### Water cooler and direct evaporator section

- state of heat transmission surface
- state of inlet and outlet duct connection
- connection of condensate drain kit
- elements and connection of cooling circuit
- state of drop eliminator

#### Plate heat exchanger section

- state of heat exchanger vanes
- functionality of bypass damper
- state of drop eliminator
- connection of condensate drain kit

### Putting device in operation

Only a person with necessary qualification may put the unit in operation. Before the first start a qualified worker must perform a revision of electric installation of all connected components of air handling device.

### Safety precautions

- Sections with accident risk (by electric current, rotating elements etc.) or with connecting points (inlet - outlet of heating water, air flow direction etc.) have always warning or informative label.
- It is prohibited to operate unit fans when the door is opened or when the panels are removed. Service panels must be during operation always closed.

- Before work on fan part is started, make sure that the main switch is off and make such moves which will prevent unintentional switching of the motor during maintenance.

- When emptying the exchanger the water temperature must be lower than 60°C. Temperature of connecting piping must also be lower than 60°C.

- Removal of life electric heater service panel is prohibited and changing production setting of safety thermostat is prohibited as well.

- Operate electric heater without outlet air temperature control and without providing steady speed of air flow is prohibited.

Putting unit in operation at not adjusted installation can only be done with closed control damper at the inlet to the unit. Operation of a unit at not adjusted installation could lead to overloading the motor and to its permanent damage. If second stage of filtration is part of the unit we recommend to perform a trial operation without inserts of second filtration degree.

### Check during first start-up of unit

- rightness of fan rotation direction according to an arrow on the impeller.
- current consumption of all connected devices (may not exceed value mentioned on the label)
- whether the water in the seal-pipe has not been sucked off. The height of the seal-pipe must be raised
- state of filter attachment

During trial operation try to notice presence of improper noises and abnormal unit vibrations for at least 30 minutes. Sources must be detected and removed. During the trial operation perform the adjustment of unit. Before starting permanent operation we recommend to regenerate or change filtration inserts. Detailed check description of a device that is being put in operation is included in the Service book for REMAK devices, where according to guaranty requirements the first operation of the device must be mentioned.

## Operation regulations, operation checks

### Unit operation - operation regulations

Before putting device in permanent operation the supplier of device (mounting firm) must issue operation regulations according to draftsman and corresponding with valid regulations. Following structure is recommended:

- composition, specification and description of air handling device operation in all modes and working states
- description of all safety and protective elements and device functions
- principles of health protection and rules of safety operation and attendance of air handling device
- requirements for eligibility and training of attendant personnel, list of workers who are authorized to operate the device.
- detailed instructions for attendance, attendance actions during emergency and failure states
- list of operation specialities in different climatic areas (summer and winter operation)
- schedule of revisions, checks and maintenance, including list of checks and method of recording

### Regular operation checks

Check activities of attendance during unit operation are focused to:

- operation and function of unit, staunchness of joints, doors and service panels, temperature of substances and transported air and filter clogging using sensors.
- state and functions of systems connected to unit and their right functionality is necessary for operation of unit and air handling system as a whole.

That means wiring, system of measuring and control, heating system (pump function, water filters /SUMX as well/), cooling system and sanitary installations - condensate outlet.

### Regular inspections

The user will determine period of regular inspections according to working conditions of unit. But at least once in 3 months. Inspection content:

#### Check of overall state

- cleaning all dirty parts of unit

#### Fans check

- check of impeller cleanness

#### Damper check

Checks for damper cleanness, slewability of damper segments and right closure of damper are performed.

#### Filter section check

- filter state and clogging
  - check setting of pressure difference sensors
- Final pressure loss (sign of max. admissible clogging) at nominal air flow is for:

**bag filters:** 300Pa for filtration classes F7, F8 and F9, 400Pa for filtration class F5, 250Pa for filtration classes G3 and G4

**frame filters:** 200Pa for filtration class G4

**metal filtration elements:** 120Pa for filtration class G3

Picture 15 – change of filtration insert

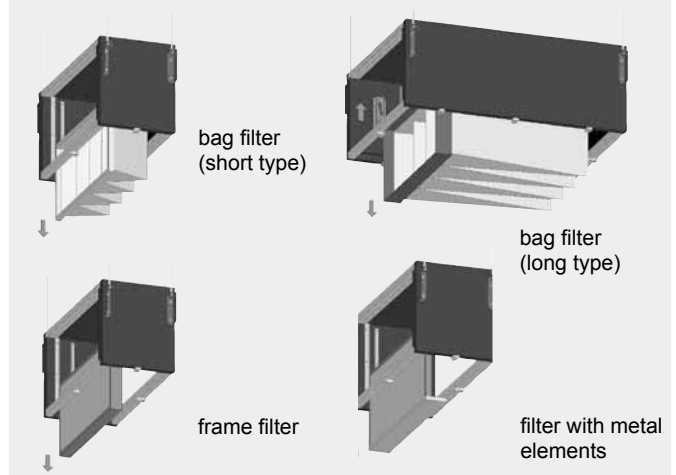

### Check of exchangers

Checks for fouling of heat transmission surfaces of exchangers, exchangers deaeration, function of condensate outlet and cleanness of drop eliminator are performed.

Cleaning is done by air stream or by cleaning with hot water with cleaner (unable to cause corrosion). Cleaning must be very careful to prevent mechanical damage to vanes.

Check and records of finding during regular before season summer and winter inspections must be done.

**Important:** during exchanger shut-down in winter, the water must be perfectly removed from the exchanger, for example by blowing the exchanger with compressed air or the exchanger must be filled with safe anti-freeze solution of water and glycol.

Excess water could cause ripping of copper pipes after freezing.

We recommend performing regular summer and winter season inspections in accordance with this installation manual.

### Electric heater check

- Check of heating coils pollution. Possible fouling can be cleaned with vacuum cleaner.
- Check functionality of safety thermostat

### Heat exchangers check

Checks of plate exchanger fouling and condensate outlet functionality is performed.

### Check measurements

Actual unit parameters must be recorded after performing regular check. Service technician will mention performed measurements.

## Spare parts, service

### Spare parts

Spare parts are not delivered with the unit. In case of need they can be ordered at REMAK a.s. or at a regional distributor. In the order please mention serial number of unit or order number and specify necessary parts.

#### Spare filtration inserts

Can be ordered as a whole set. You only need to set filter type (bag, frame, with metal elements - pic.17), size of FP unit and appropriate filtration class. Types of separate inserts that the filter is composed of don't have to be mentioned.

**Table 6 – replacement filter inserts**

Kit designation	Quantity	Basic dimensions (mm), filtration class and number of bags
<b>Replacement FPNH bag filter</b>		
FPNH 2.7/3	1	605x305x195 G3 /6 bags
FPNH 2.7/4	1	605x305x360 G4 /6 bags
FPNH 2.7/5	1	605x305x500 M5 /6 bags
FPNH 2.7/7	1	592x287x635 F7 /7 bags
FPNH 2.7/8	1	592x287x635 F8 /7 bags
FPNH 2.7/9	1	592x287x635 F9 /3 bags
FPNH 4.0/3	1	910x305x195 G3 /9 bags
FPNH 4.0/4	1	910x305x360 G4 /9 bags
FPNH 4.0/5	1	910x305x500 M5 /9 bags
FPNH 4.0/7	1	287x287x635 F7 /3 bags
	1	592x287x635 F7 /7 bags
FPNH 4.0/8	1	287x287x635 F8 /3 bags
	1	592x287x635 F8 /7 bags
FPNH 4.0/9	1	287x287x635 F9 /3 bags
	1	592x287x635 F9 /7 bags
<b>Replacement FPNR frame filter</b>		
FPNR 2.7/4	1	305x605x44 G4 cardboard
FPNR 4.0/4	1	305x910x44 G4 cardboard
<b>Replacement FPNT metal insert</b>		
FPNT 2.7/3	1	305x605x20 G3
FPNT 4.0/3	1	305x910x20 G3

### Service

Guarantee and after guarantee actions can be ordered either at REMAK a.s. or at a regional distributor. The producer can authorize other trained service companies. Their list can be found at [www.remak.eu](http://www.remak.eu).

### Disposal and Recycling

When using or disposing of the air-handling, it is necessary to observe the respective national environmental protection and waste disposal regulations. In case of final liquidation of the unit, it is necessary to follow the policy of sorted waste disposal; this means to respect differences in materials and their composition. It is necessary to hire a provider specialized in sorted waste disposal in accordance with applicable local standards and regulations. After exceeding its service life limit, the unit belongs to a waste group according to the Waste Act (No.185/2001 Sb.) This product belongs to the Q14 waste group.

#### Waste Classification

(in accordance with Directive No. 381/2001 Sb.)

#### Materials used to pack the product:

15 01 01 cardboard box (paper and cardboard packaging products)

15 01 02 polyester packaging pads (plastic packaging products)

15 01 03 pallet (wooden packaging products)

#### Disabled device and its parts:

16 02 06 metal and aluminium parts, insulating material

15 02 03 filtering materials

16 02 15 electrical parts (dangerous items from disabled devices)



It is always necessary to observe local laws and directives!





## Notes

**Notes**

*Print and language mistakes reserved.*

*Permission for re-printing or copying of "Installation and service instructions" (either a part or a whole) must be obtained in written form from company REMAK a.s., Zuberská 2601, Rožnov p. R.. This "Installation and service instructions" is exclusive property of company REMAK a.s.. Right for changes reserved.*

*Date of issue: 10. 7. 2013*



REMAK a.s.  
Zuberská 2601, 756 61 Rožnov pod Radhoštěm,  
tel.: +420 571 877 778, fax: +420 571 877 777,  
email: [remak@remak.eu](mailto:remak@remak.eu), internet: [www.remak.eu](http://www.remak.eu)