



Air-handling units

NEW DIMENSION OF COOPERATION

TABLE OF CONTENTS

Table of contents	1	Heat Recovery	34
Basic properties	2	Rotary Regenerative Heat Exchanger.....	34
Design and Parameters.....	4	Plate Heat Exchanger	36
Outputs and Standards.....	6	Glycol Circuit.....	37
Dimensional Variability and Optimisation.....	7	Noise attenuation.....	38
Materials and Design.....	8	Noise Attenuators.....	38
Air-handling Unit Casing Code Designation	10	Mixing.....	39
Internal Assembly Codes by Type – Basic Overview	11	Mixing Chamber.....	39
Internal Assembly and Accessory Overview.....	12	Corner Chamber	39
Fans	14	Accessories.....	40
Fans with Overhung Impeller	14	Siphons	40
Fans with Belt Drive.....	16	Condensate Drainage Tray.....	40
Fans with Back-up Motors.....	18	Drop Eliminator.....	41
Filters.....	19	Blade Dampers	41
General Properties	19	Base Frame	42
Filter groups, properties and typical examples of application	20	End Panel.....	42
Woven Filter Inserts	21	Roofs	42
Metal Filters	21	Louvers	43
Filters.....	22	Outlet Adaptor	43
Frame Filters	22	Elastic Connection.....	43
Bag Filters.....	22	Mixing Sets.....	43
Compact Filters.....	23	Measuring & Control.....	44
Grease Filters.....	23	Comprehensive Solution.....	44
Active Carbon Filters.....	24	VCS.....	44
Combined Assemblies.....	24	Frequency Inverters.....	45
Heating.....	25	Actuators and Sensors.....	45
Water Heaters	25	Units for explosion areas.....	46
Gas Heater.....	26	Hygiene version of the units.....	47
Electric Heater	27	Connection.....	48
Cooling	28	Mollier h-x Chart.....	49
Water Cooler.....	28		
Direct Evaporator	29		
Integrated cooling.....	30		
Humidification	32		
Steam Humidification	32		
Adiabatic Humidification.....	33		

BASIC PROPERTIES

AeroMaster Cirrus air-handling units enable you to implement specific applications complying with the strictest demands for environmental cleanliness with an air flow of up to 99,200 m³/h. AeroMaster Cirrus air-handling units are designed for installation on floors or substructures, and are delivered with a rigid base frame mounted in the factory. AeroMaster Cirrus Units are currently available in eight dimensional ranges. AeroMaster Cirrus air-handling units can be used in normal rooms (IEC 60364-5-51, resp. ČSN 332000-5-51 2, ČSN 332000-3) and in rooms with extended ambient temperature range from -30°C to +40°C without additional measures - this applies to the standard version. Custom-made units with reduced -40°C to +40°C or increased -30°C + 50°C temperature range of transported air can also be delivered.



CREATIVE SOLUTION OF THE CASING

When designing AeroMaster Cirrus air-handling units, we used two unique principles: a laminated wall combined with a self-contained panel. The achieved parameters in accordance with EN 1886-2008, which were confirmed by the TÜV SÜD conformity assessment protocol, enable us to implement specific applications complying with the strictest demands for environmental cleanliness. AeroMaster Cirrus air-handling units are also suitable for specific applications, such as coastal environments and pools.

The casing's design is protected as an industrial design and has patents pending.



TAILORED TO YOUR SIZE

The laminated AeroMaster Cirrus concept allows you to select the unit height and width for air-handling units in a vertical or horizontal arrangement according in the basic heights of four and six modules (lamellas) for your actual space requirements. The unique casing design allowed us to abandon the traditional air handling unit sections and the relationship between air handling unit casing and internal components. The AeroMaster Cirrus concept is able to „enwrap“ internal components with minimum spacing using a casing of optimal length.



OPTIMIZED OUTPUT ACCORDING TO ENERGY CLASSES

AeroMaster Cirrus air-handling units cover quite a wide output range. In the A energy class (i.e. at air velocity up to 2.5 m/s), these units offer outputs from 20,900 m³/h to 62,000 m³/h. Lower air outputs can be conveniently ensured by the well proven AeroMaster XP air-handling units



BASIC PROPERTIES

Knowledge of our customers' needs, European regulations and local regulations in different countries, as well as the long-term experience of our team has enabled us to develop and launch a new generation of air-handling units. This generation features not only significantly improved parameters but also greater reliability. Production efficiency has also been improved. New AeroMaster Cirrus® air-handling units significantly enhance the quality level of REMAK air-handling units and set a new, higher standard.



■ GOST Certificate



■ EC declaration of conformity



SIMPLE INSTALLATION AND FAST SERVICING

With the goal of utilizing the knowledge we have gained from different applications and using information gained from cooperation with you, we focussed on providing excellent access to the internal space when designing the service side of these new air-handling units. We have kept in mind both service access to individual internal components as well as easy cleaning of the unit's internal space in hygienic applications.



KEEPING ENERGY IN THE MAINS

The contractor usually ends up with an energy alphabet. For us it is a start and we go even further than others:

- Designed in energy class A+
- Highly efficient heat recovery of up to 85%
- Highly efficient fans IE2
- Minimized pressure loss of built-in assemblies
- Excellent casing tightness L1 (M)



YOU CAN RELY UPON OUR PRODUCTS

When developing the AeroMaster Cirrus air-handling units, we closely adhered to the requirements of technical standards, directives and laws to give you the right conditions to create the given design with maximum energy economy while complying with highly demanding hygiene and environmental requirements.

DESIGN AND PARAMETERS

LAMINATED WALL

- High strength and tightness
- The thin steel sheet and lightweight insulation used for the unit production ensure excellent parameters for the category of air-handling units without aluminium frames.
- Environmentally-friendly, waste-less and low energy consumption production
- Fast installation using kanban pads results in short times needed for panel production.

SELF-CONTAINED PANEL

- Simple Installation
- High mechanical strength and tightness of the casing contributes to energy savings.
- Very good thermal insulation
- Excellent casing attenuation.

INSULATION

- The casing is insulated by two types of insulation.
- The upper, rear and service walls are insulated with fireproof mineral wool of 50 kg/m³ density, which is an optimal material for acoustic attenuation.
- The lower wall is insulated with 35 kg/m³ density self-extinguishing PUR/PIR insulation, class B2 in accordance with DIN 4102. Using this type of insulation, the great rigidity and pressure resistance of the lower wall is ensured. These features enable trouble-free service access (unit bearing capacity for stepping) even for larger-sized units.

CONNECTING FRAME

- Internal connection of blocks. Internal connection provides the unit with an undisturbed aesthetical exterior.
- The holes are prepared so that minor unevenness of the foundations can be aligned.
- No special tools are needed for the installation.



SERVICE WALL

- Easy access to internal assemblies
- Unique double-wing door as standard
- Easy-to-remove panels and service wall doors
- Easy to connect to media feeds
- Access walkway

DISASSEMBLY

- Easy-to-remove service wall panels
- Possibility to deliver disassembled units

DESIGN AND PARAMETERS



■ CASING MECHANICAL STRENGTH	D1 (M)
■ CASING AIR LEAKAGE	L1 (M)
■ FILTER BYPASS LEAKAGE	< 0,5% (F9)
■ THERMAL INSULATION	T2
■ THERMAL BRIDGING	TB3
■ OPERATING TEMPERATURE	-40 TO +50°C
■ CASING ACOUSTIC INSULATION (dB/OCTAVE BAND)	12,1/125 Hz, 13,4/250 Hz, 17,2/500 Hz, 26,5/1 kHz, 29,7/2 kHz, 34,2/4 kHz, 40,5/8 kHz



SEALING

- Suitable for hygienic applications
- Sealing used in units complies with EN 13053-2006 and EN 1886.
- The sealing material with a closed cell structure is moisture resistant.

BASE FRAME

- A base frame 85 mm (smaller unit lines) or 150 mm (bigger unit lines) in height.
- Raised base frame (with legs).

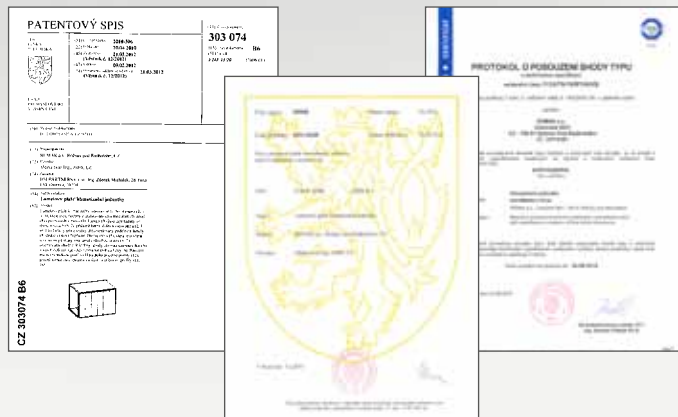

PROTECTED DESIGN

- Protected as an industrial design and patents pending
- Compatibility confirmed by the TÜV SÜD Type Assessment Certificate

OUTPUTS AND STANDARDS

OUTPUTS OF AEROMASTER CIRRUS UNITS IN BASIC DIMENSIONAL RANGE

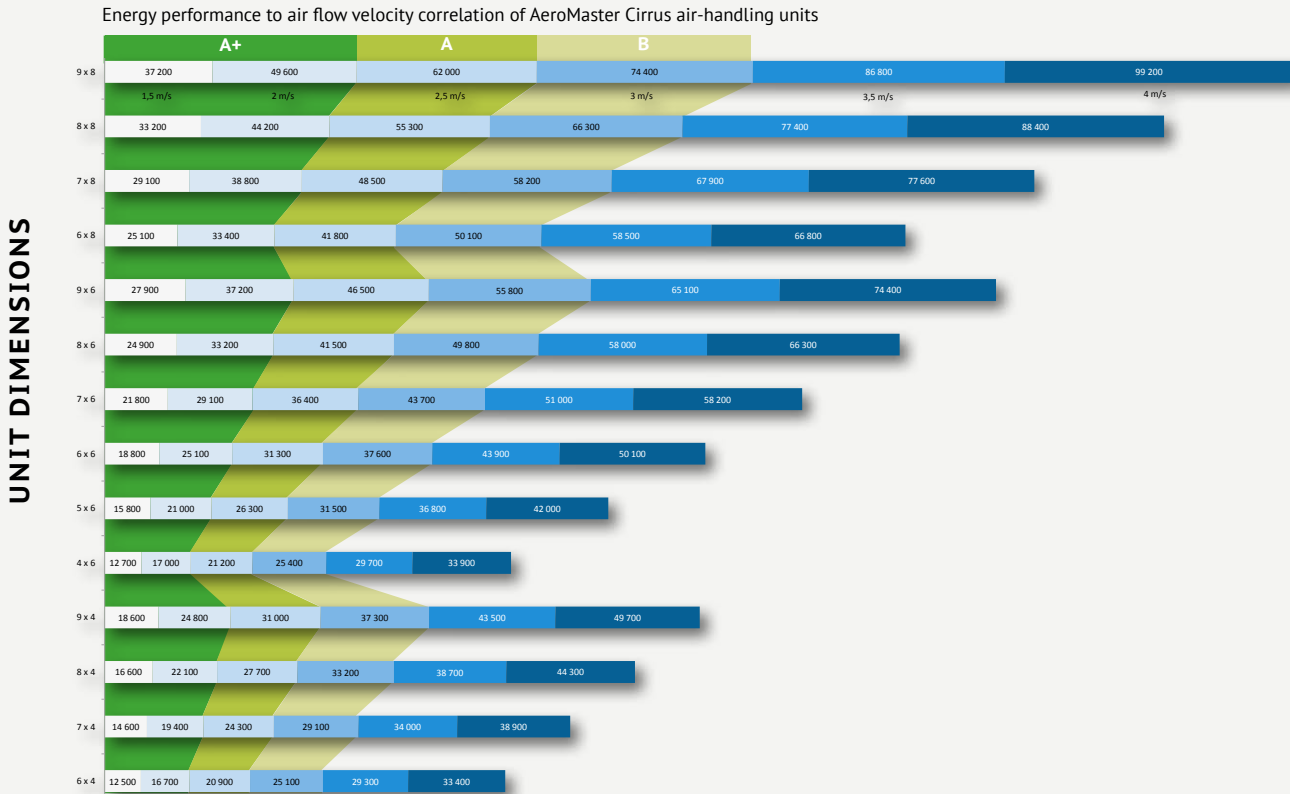

Example of quick output and dimension calculation: $6 \times 4 = 24\,000 \text{ m}^3/\text{hod}$ at speed 2.8 m/sec

IMPORTANT STANDARDS AND DIRECTIVES FOR THE DESIGN OF AIR-HANDLING SYSTEMS

REQUIREMENTS FOR BUILDINGS	REQUIREMENTS FOR AIR-HANDLING SYSTEMS	REQUIREMENTS FOR AIR-HANDLING UNITS
Directive 2010/31/EU on the energy performance of buildings	EN 13779 Ventilation-performance requirements for ventilation and room-conditioning systems	EN 1886 Ventilation for buildings – Air handling units – Mechanical performance
Law No. 406/2000 Sb. on energy economy, Order No. 148/2007 on the energy performance of buildings	EN 15242 Ventilation for buildings-Calculation methods for the determination of air flow rates in buildings including infiltration	EN 13053+A1 Ventilation for buildings. Air handling units. Ratings and performance for units, components and sections
EN 15251 Indoor environmental input parameters for design and assessment of energy performance of buildings addressing indoor air quality, thermal environment, lighting and acoustics	EN 15243 Ventilation for buildings – Calculation of room temperatures and of load and energy for buildings with room-conditioning systems	VDI 6022 Hygiene requirements for ventilation and air-conditioning systems and devices
EN 15240 Ventilation for buildings – Energy performance of buildings – Guidelines for inspection of air-conditioning systems	EN 12599 Ventilation for buildings - Tests procedures and measuring methods for handing over installed ventilation and air conditioning systems	VDI 3803 Air-conditioning – Central Air-conditioning Systems – Structural And Technical Principles
EN 15239 Ventilation for buildings – Energy performance of buildings – Guidelines for inspection of ventilation systems	EN 15423 Ventilation for buildings – Fire precautions for air distribution systems in buildings	DIN 1946-4 Ventilation in buildings and health care rooms

DIMENSIONAL VARIABILITY AND OPTIMISATION

CROSS-SECTION VARIABILITY

Cross-section variability is enabled by the arrangement of four, six and eight modules (laminas) at basic heights.

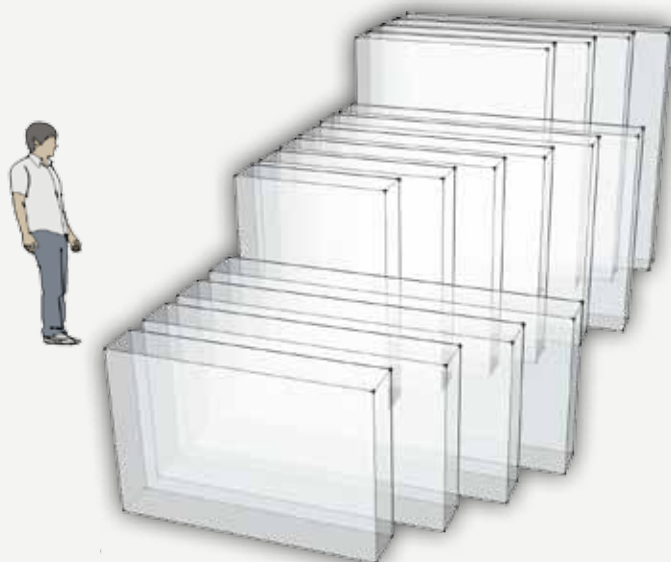

MODULES/DIMENSIONS IN MM CONVERSION

MODULES (NUMBER)		DIMENSIONS (MM)	
WIDTH	HEIGHT	WIDTH	HEIGHT
6	4	1836 mm	1224 mm
7	4	2142 mm	1224 mm
8	4	2448 mm	1224 mm
9	4	2754 mm	1224 mm
4	6	1224 mm	1836 mm
5	6	1530 mm	1836 mm
6	6	1836 mm	1836 mm
7	6	2142 mm	1836 mm
8	6	2448 mm	1836 mm
9	6	2754 mm	1836 mm
6	8	1836 mm	2448 mm
7	8	2142 mm	2448 mm
8	8	2448 mm	2448 mm
9	8	2754 mm	2448 mm

TAILORED PRECISELY TO YOUR NEEDS

Different locations – different customers - different needs. The laminated AeroMaster Cirrus concept allows you to select the unit height and width for air-handling units in a vertical or horizontal arrangement according to your actual space requirements.

NEW CONCEPT OF MINIMIZED LENGTH DIMENSIONS

The unique casing design allowed us to abandon the traditional air handling unit sections and the relationship between the air handling unit casing and internal components. The traditional concept of predefined sections related to the particular built-in components is now consigned to the past. The AeroMaster Cirrus concept is able to „enwrap“ internal components with minimum spacing using a casing of optimal length.

The length dimensions of each functional part (built-in assembly) of the air-handling unit are designed in modular grid lengths equalling multiples of 102 mm. These functional parts are then integrated into assembly (transport) blocks in lengths equalling multiples of 306 mm (modular width of the lamina). This combination allows the air-handling unit to be designed to just the required length dimensions.

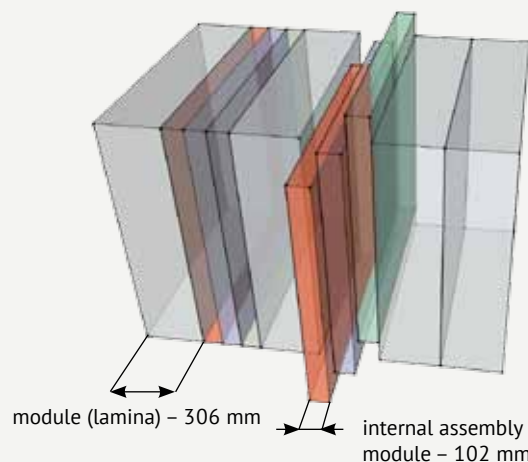

OPTIMIZED INTERNAL ASSEMBLIES

The design of some built-in assemblies itself contributes to the optimized length of the units. Combined filtration walls are a good example of this. For example, fitting two filters into the common frame will result in maximum reduction of the length.

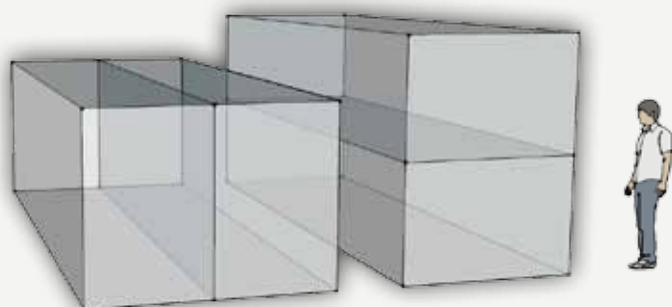

MATERIALS AND DESIGN

AeroMaster Cirrus air-handling units are designed for outdoor and indoor applications in normal environments. Thanks to the surface finish combinations (hot-dip galvanizing, powder coating, and stainless steel) which comply with the grade of atmospheric corrosiveness in accordance with EN 12500 and corrosion resistance in accordance with EN ISO 14713, the AeroMaster Cirrus® concept allows deliveries of air-handling units that fulfil the requirements of the highest applicable standards. Achieved parameters allow even specific applications with the greatest demands for environmental cleanliness to be completed. AeroMaster Cirrus air-handling units are also suitable for specific applications, like coastal environments, pools, etc.

CORROSION RESISTANCE AS PER EN ISO 14713		
CLASS	CORRODING ENVIRONMENT	CORROSIVITY
C1	Interior: dry	very low
C2	Interior: intermittent moisture	low
	Exterior: open landscape	
C3	Interior: high humidity and slightly polluted environment	medium
	Exterior: industrial environments, coastal locations	
C4	Interior: pools, chemical plants, etc.	high
	Exterior: industrial and coastal areas	
C5	Exterior: industrial emissions along with high humidity and intense influence of a sea environment	very high

SURFACE FINISHES FOR ANY APPLICATION

REMAK air-handling units are characterized by their long service intervals and trouble-free operation. Thanks to the surface finish combinations (hot-dip galvanizing, powder coating, and stainless steel) which comply with the grade of atmosphere corrosiveness in accordance with EN 12500 and corrosion resistance in accordance with EN ISO 14713.



Hot-dip galvanized and RAL powder coated external casing, hot-dip galvanized and RAL powder coated frame



Example of combination of internal casing (hot-dip galvanized) and external casing (hot-dip galvanized and RAL powder coated)



Hot-dip galvanized external casing, hot-dip galvanized frame

MATERIALS AND DESIGN

AEROMASTER CIRRUS UNIT SURFACE FINISH

CASING DESIGN CODE	FRAME	INTERNAL CASING	EXTERNAL CASING	CORROSIVITY	APPLICATION
0	hot-dip galvanized	hot-dip galvanized	hot-dip galvanized	C2/C2	air-handling units for indoor environment - low corrosivity (air-handling units for outdoor environment - low corrosivity) **
1	hot-dip galvanized + RAL powder-coated	hot-dip galvanized	hot-dip galvanized + RAL powder-coated	C2/C4	air-handling units for indoor environment, design - low corrosivity air-handling units for outdoor environment - low corrosivity
2	hot-dip galvanized + RAL powder-coated	hot-dip galvanized + RAL powder-coated	hot-dip galvanized	C4/C2	air-handling units for indoor environment - high air corrosivity
3	hot-dip galvanized + RAL powder-coated	hot-dip galvanized + RAL powder-coated	hot-dip galvanized + RAL powder-coated	C4/C4	air-handling units for indoor environment, design - high air corrosivity air-handling units for outdoor environment, design - high air corrosivity
4	hot-dip galvanized + RAL powder-coated	hot-dip galvanized + RAL powder-coated epoxy coating	hot-dip galvanized + RAL powder-coated	-	version for pools
5	hot-dip galvanized + RAL powder-coated	hot-dip galvanized + RAL powder-coated stainless steel (304 AISI / X5CrNi18-10 ISO)	hot-dip galvanized + RAL powder-coated	-	hygienic version
6	hot-dip galvanized + RAL powder-coated	hot-dip galvanized + RAL powder-coated stainless steel (316L AISI / X2CrNiMo17-12-2 ISO)	hot-dip galvanized + RAL powder-coated	C5 economy * 1/C4	air-handling units for indoor environment - very high air corrosivity (air-handling units for outdoor environment, design - very high air corrosivity) **
7	hot-dip galvanized + RAL powder-coated	stainless steel (316L AISI / X2CrNiMo17-12-2 ISO)	hot-dip galvanized + RAL powder-coated	C5 economy * 2/C4	air-handling units for indoor environment - very high air corrosivity (air-handling units for outdoor environment, design - very high air corrosivity) **
8	hot-dip galvanized + RAL powder-coated	stainless steel (316L AISI / X2CrNiMo17-12-2 ISO)	stainless steel (316L AISI / X2CrNiMo17-12-2 ISO)	C5/C5	air-handling units for indoor environment - very high air corrosivity air-handling units for outdoor environment, design - ver high air corrosivity

* Possible application variant taking into account the material price

** Possible application variant taking into account the operating conditions and concentration of pollutants in the air

AIR-HANDLING UNIT CASING CODE DESIGNATION

POSITION										
AIR-HANDLING UNIT TYPE		CASING		CASING TYPE		WIDTH	HEIGHT	LENGTH	MATERIALS AND DESIGN	UNIT FINAL ASSEMBLY
1	2	3	4	5	6	7	8	9	10	
C	R	S	x	x	x	x	x	x	x	x

AeroMaster
Cirrus

the following positions specify the casing design

WAY OF DELIVERY

M = unit block delivery (the unit blocks are assembled in the factory)

P = disassembled unit delivery (the internal assemblies and casing components are delivered separately and assembled)

MATERIAL AND SURFACE FINISH COMBINATION OF CASING COMPONENTS

- 0
- 1
- 2
- ...
- 8

For the meaning of numbers 0 and 8, refer to the table on previous page.

LENGTH IN NUMBER OF MODULES PER BLOCK

- 0
- 1
- 2
- ...
- 9

The total length of the block is the sum of the laminated wall length (number of 306 mm modules) and air-handling unit's frame (102 mm).

DIMENSIONAL RANGE - DESIGNATION BY NUMBER OF MODULES

Width	Height
4	4
5	4
6	4
7	4
8	4
9	4
4	6
5	6
6	6
7	6
...	...
9	8

The dimensional range is being continuously extended.

CASING TYPES

S	0	Standard
R	0	Vertical arrangement of the rotary heat exchanger
R	1	Horizontal arrangement of the rotary heat exchanger
D	0	Vertical arrangement of the plate heat exchanger
D	1	Horizontal arrangement of the plate heat exchanger
G	0	Gas Heater

INTERNAL ASSEMBLY CODES BY TYPE – BASIC OVERVIEW

FANS	Fan assembly, forward curved blades, belt drive	C R V A A
	Fan assembly, forward curved blades, belt drive – stand by	C R V A B
	Fan assembly, backward curved blades, belt drive	C R V A C
	Fan assembly, backward curved blades, belt drive – stand by	C R V A D
	Fan assembly, overhung impeller (plug fans)	C R V A E
	Fan assembly, overhung impeller (plug fans), EC motor	C R V A F
	Diffuser assembly	C R V A G
FILTERS	Filter assembly – bag filters	C R V F A
	Filter assembly – compact filters	C R V F B
	Filter assembly – frame filters	C R V F C
	Filter assembly – insert filters	C R V F D
	Filter assembly – metal filters	C R V F E
	Filter assembly – grease filters (metal filter with condensate tray)	C R V F F
	Filter section – active carbon	C R V F I
HEATING	Water heater assembly	C R V B A
	Electric heater assembly	C R V B E
	Gas Heater assembly	C R V B G
COOLING	Water cooler assembly	C R V C A
	Direct Evaporator assembly	C R V C B
	Integrated cooling assembly	C R V S A
HUMIDIFICATION	Humidifier assembly – steam humidifier	C R V G A
	Humidifier assembly – honeycomb adiabatic humidifier	C R V G C
HEAT RECOVERY	Rotary heat exchanger assembly – vertical arrangement	C R V H A
	Rotary heat exchanger assembly – horizontal arrangement	C R V H B
	Plate heat exchanger – vertical arrangement	C R V I A
	Plate heat exchanger – horizontal arrangement	C R V I B
	Glycol circuit assembly	C R V K A
NOISE ATTENUATION	Attenuator assembly	C R V L A
DROP ELIMINATOR	Drop eliminator assembly	C R V D A
CONNECTION, MIXING	Mixing	C R V E A
	Corner chamber	C R V M A
REPLACEMENT FILTER KITS	Replacement filter kit – bag filter	C R N A O
	Replacement filter kit – compact filter	C R N B O
	Replacement filter kit – frame filter	C R N C O
	Replacement filter kit – insert filter	C R N D O
	Replacement filter kit – metal filter	C R N E O
	filter kit – grease filter (metal with a collection tray)	C R N F O
	Replacement filter kit – bag filters	Depending on the specific application

Note: The AeroMaster Cirrus unit size (two characters) + filtration class (two characters) 03 up to 09 must be added after the unit's size.

INTERNAL ASSEMBLY AND ACCESSORY OVERVIEW

AIR TRANSPORT

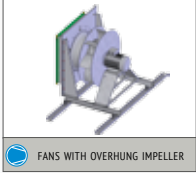

FANS WITH OVERHUNG IMPELLER

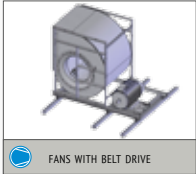

FANS WITH BELT DRIVE

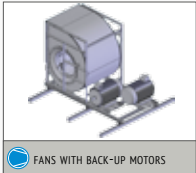

FANS WITH BACK-UP MOTORS

FILTRATION



WOVEN INSERTS

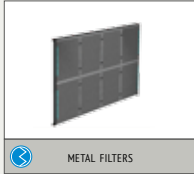

METAL FILTERS

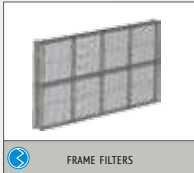

FRAME FILTERS

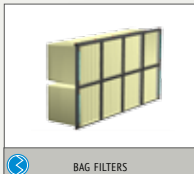

BAG FILTERS

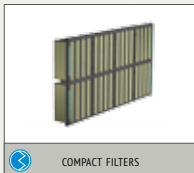

COMPACT FILTERS



GREASE FILTERS



ACTIVE CARBON FILTERS



COMBINED ASSEMBLIES

HEATING



WATER HEATER



ELECTRIC HEATER

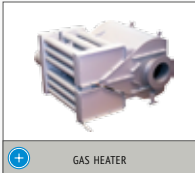

GAS HEATER

COOLING



WATER COOLER

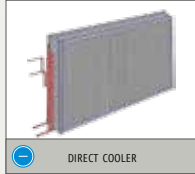

DIRECT COOLER

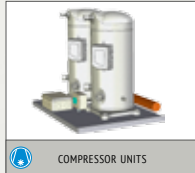

COMPRESSOR UNITS

HUMIDIFICATION



STEAM HUMIDIFIER

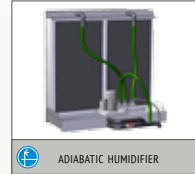

ADIABATIC HUMIDIFIER

HEAT RECOVERY

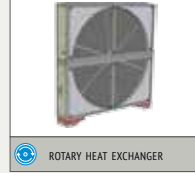

ROTARY HEAT EXCHANGER



PLATE EXCHANGER

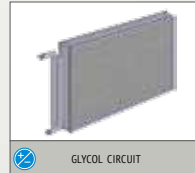

GLYCOL CIRCUIT



INTERNAL ASSEMBLY AND ACCESSORY OVERVIEW

NOISE ATTENUATION



MIXING



ACCESSORIES

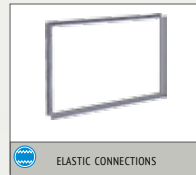
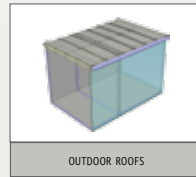
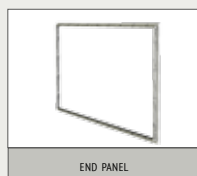
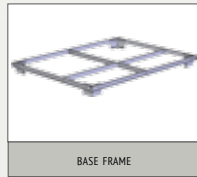
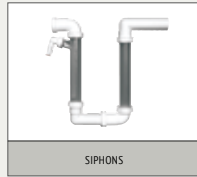

EXPLANATION OF SYMBOLS

- Ventilation (air transport)



- Filtration



- Heating



- Cooling



- Humidification



- Heat recovery



- Noise attenuation



- Mixing



- Control



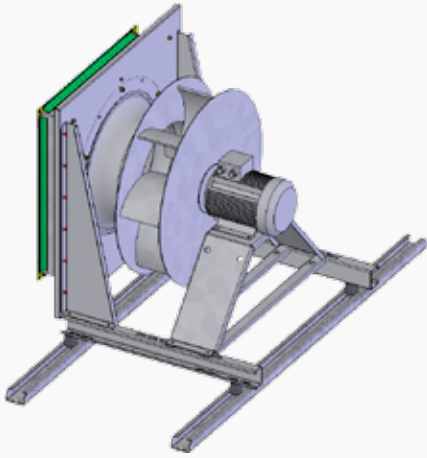

FANS WITH OVERHUNG IMPELLER

- Radial fans equipped with backward curved blades a spiral fan casing (plug fans).
- The impeller is fixed directly to the motor shaft using Taper Lock collets.
- The impeller is made of a composite (up to max. size 630 mm) or steel. Both types feature high efficiency. Especially the plastic overhung impellers feature excellent acoustic properties.
- The motor on the common frame is insulated from the internal casing by rubber silent-blocks and an insulation pad.
- These fans are driven by single-speed motors equipped with a frequency inverter speed control.
- As standard, these motors are equipped with thermal protection (thermo-contacts, PTC thermistors).
- The motor's electrical protection degree is IP 55, insulation class F.
- 3 x 400V/50 Hz AC
- The fan and motor assembly is balanced for max. 2.8 mm/s in accordance with DIN ISO 14694.
- These fans are designed for applications with total pressures up to 2000 Pa.
- Easy to clean, they are suitable for applications with increased hygiene demands.

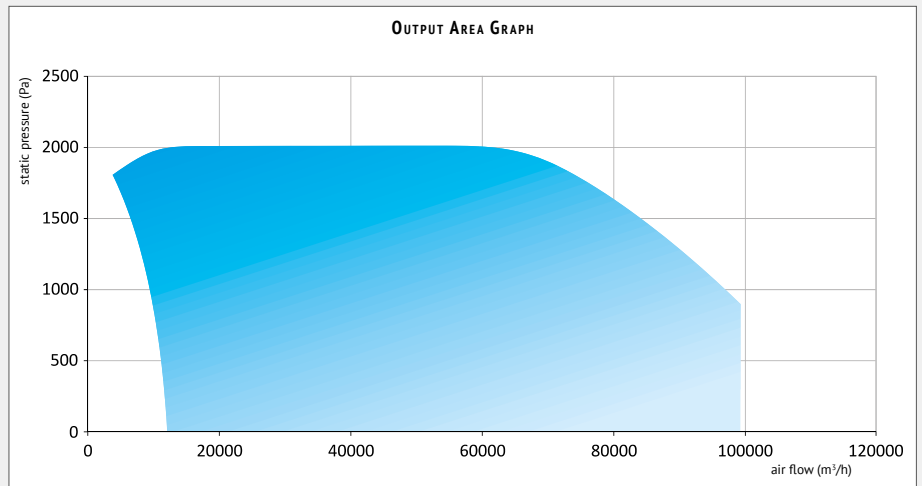

MODULES		A	B	FAN DIMENSIONAL RANGES
WIDTH	HEIGHT	mm	mm	
6	4	1836	1946	560, 630, 710, 800
7	4	2141	2251	560, 630, 710; 2 × 500, 2 × 560, 2 × 630
8	4	2446	2556	630, 710, 800; 2 × 560, 2 × 630, 2 × 710
9	4	2751	2861	630, 710, 800; 2 × 560, 2 × 630, 2 × 710
4	6	1226	1336	560, 630, 710, 800
5	6	1531	1641	630, 710, 800, 900
6	6	1836	1946	710, 800, 900, 1000
7	6	2141	2251	710, 800, 900, 1000
8	6	2446	2251	800, 900, 1000; 2 × 710, 2 × 800
9	6	2751	2251	800, 900, 1000; 2 × 800, 2 × 900
6	8	2251	2446	800, 900, 1000, 1100
7	8	2141	2446	900, 1000, 1100
8	8	2446	2446	900, 1000, 1100; 2 × 800
9	8	2751	2446	1000, 1100; 2 × 800, 2 × 900

INLET AND OUTLET CONFIGURATIONS

The configuration with a side outlet is limited to directing the outlet to the non-service side (fan assembly).

This limitation of the air outlet in relation to the air-handling unit service accesses can be eliminated by reversing only the fan assembly service access locations.

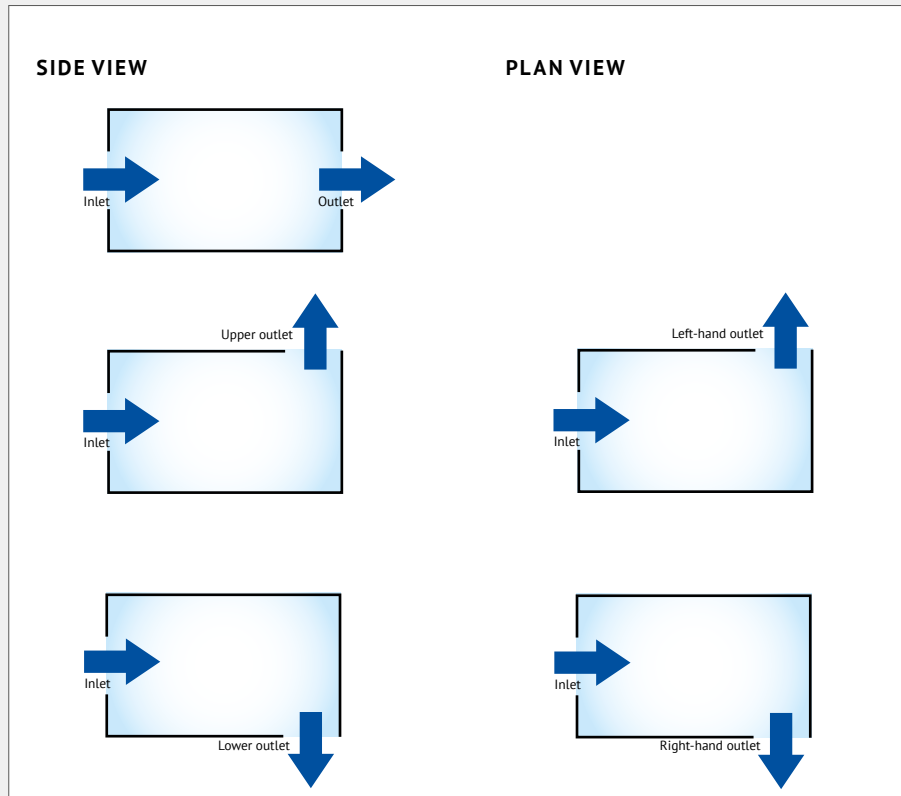

The fans can be installed either separately or in pairs installed in parallel side by side.

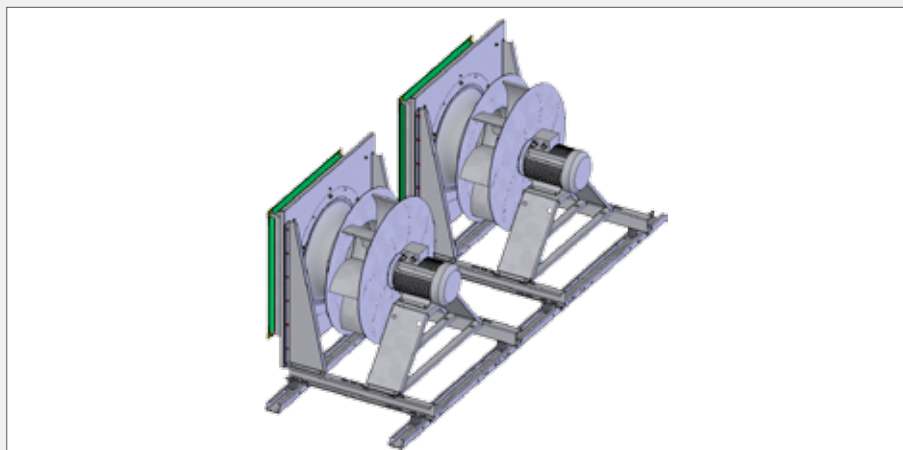

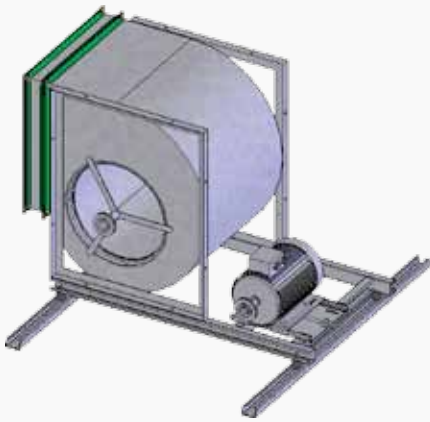

FANS WITH BELT DRIVE

- Double inlet radial fans equipped with backward or backward curved blades.
- The pulleys are fixed directly to the fan shaft using Taper-Lock collets.
- The required parameters – fan efficiency and sound power – can be achieved through selection of the impeller type.
- The motor on the common frame is insulated from the internal casing by rubber silent-blocks and insulation pad.
- These fans are driven by single-speed IEC motors optionally equipped with a frequency inverter speed control.
- As standard, these motors are equipped with thermal protection (thermo-contacts, PTC thermistors).
- The motor's electrical protection degree is IP 55 (IP 54 EC), insulation class F.
- 3 × 400 V/50 Hz AC.
- The fans are balanced.
- These fans are designed for applications with total pressures up to 2500 Pa.

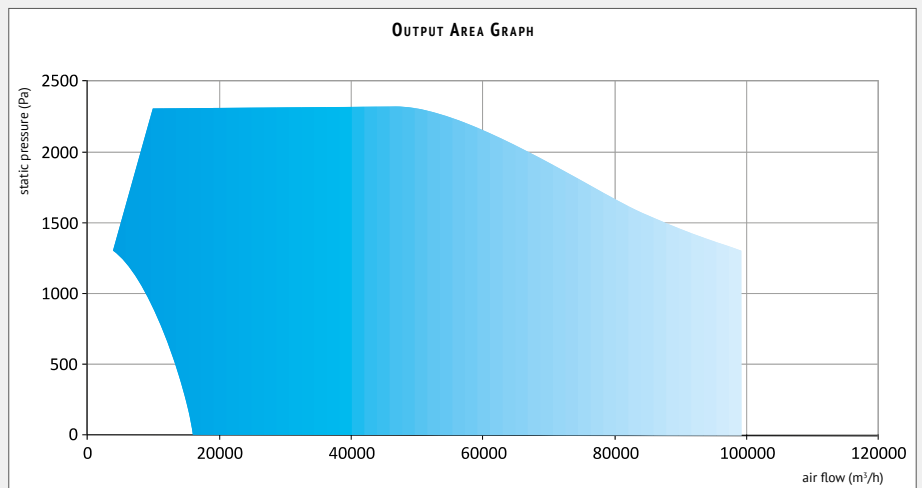

MODULES		FAN DIMENSIONAL RANGES
WIDTH	HEIGHT	
6	4	500, 560, 630
7	4	500, 560, 630, 2 × 450, 2 × 500
8	4	560, 630, 2 × 450, 2 × 500, 2 × 560
9	4	2 × 450, 2 × 500, 2 × 560, 2 × 630
4	6	500, 560, 630
5	6	560, 630, 710
6	6	630, 710, 800, 900
7	6	630, 710, 800, 900
8	6	710, 800, 900
9	6	710, 800, 900, 2 × 710
6	8	710, 800, 900
7	8	800, 900, 1000
8	8	900, 1000, 1120
9	8	900, 1000, 1120, 2 × 710

INLET AND OUTLET CONFIGURATIONS

The configuration with a side outlet is limited to directing the outlet to the non-service side (fan assembly) - this limitation of the air outlet in relation to the air-handling unit service accesses can be eliminated by reversing only the fan assembly service access locations.

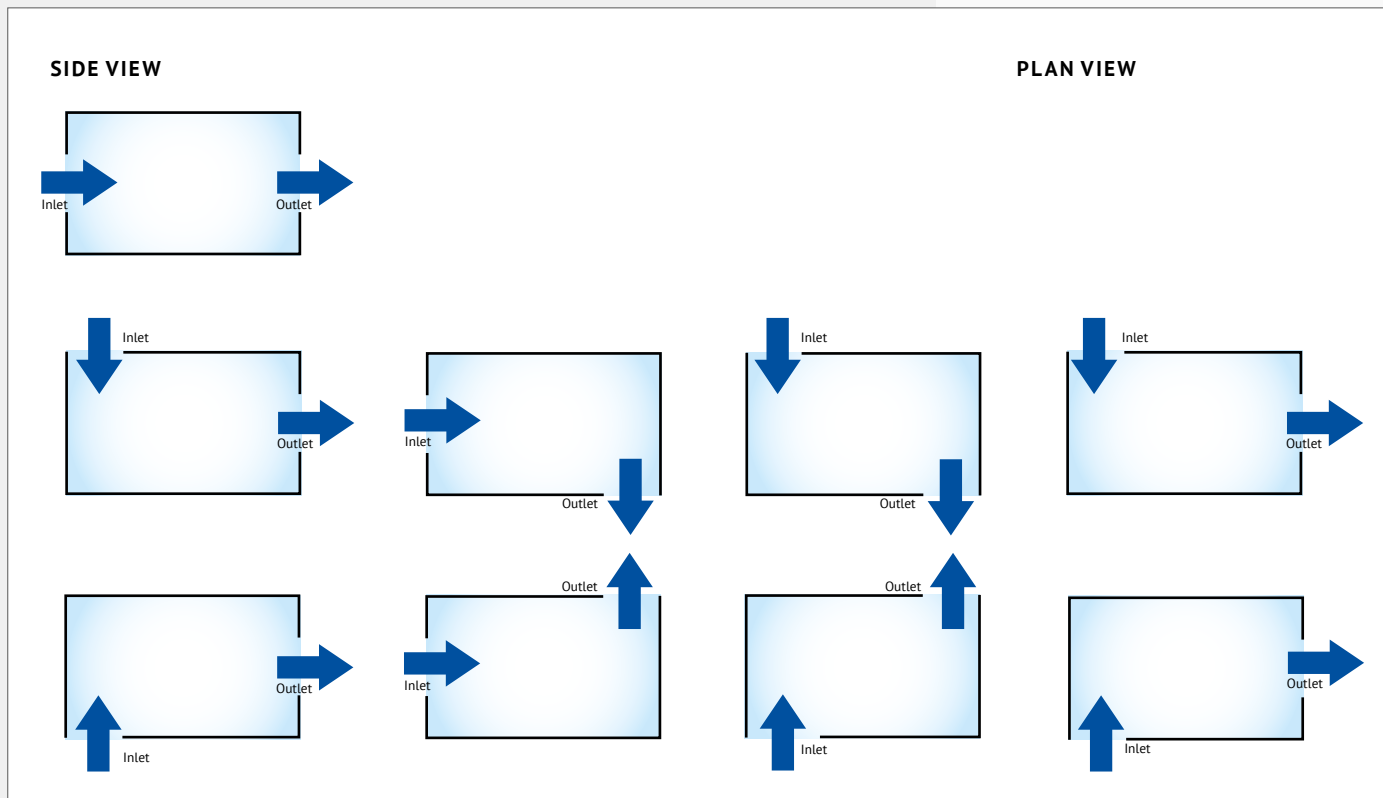

The fans can be installed either separately or in pairs installed in parallel side by side.

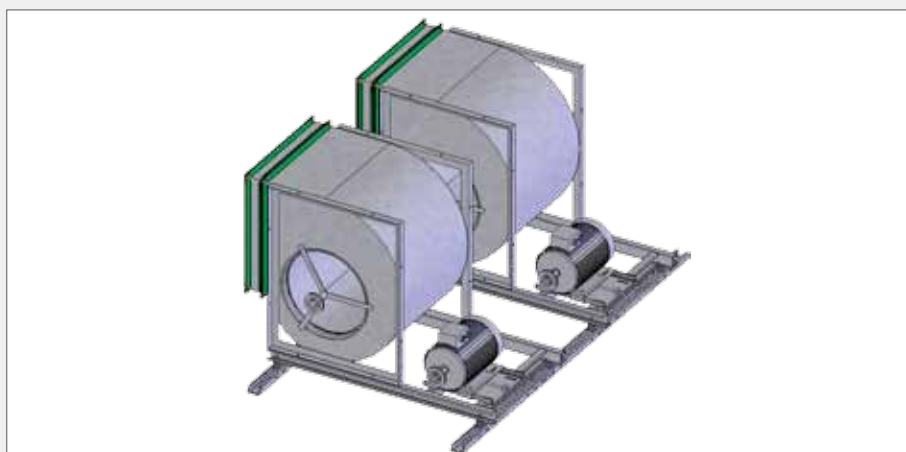

The fan's design for a given working point can be performed using AeroCAD design software.

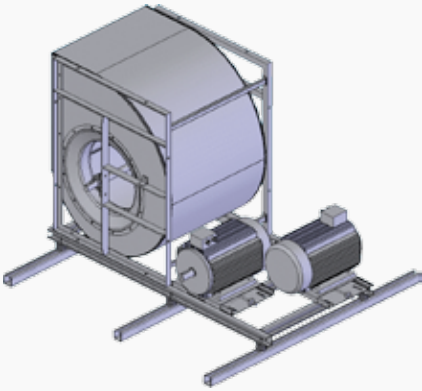

FANS WITH BACK-UP MOTORS

The fan assembly, with a backup motor (drive) for the „backup“ function, is equipped with two independent motors with belt drives leading to the common shaft of the fan. The backup function is designed so that the main motor runs in basic mode while the second/backup motor will only run if the main motor fails.

Backup is ensured by automatic start-up of the backup motor if the main fan motor has failed.

If the Remak control system is part of the delivery, the back-up motor assembly will always be fitted with two dP air-flow sensors. One sensor is assigned to the main fan motor while the other is assigned to the backup fan motor. Information on main fan motor failure from the assigned sensor is sent by means of a warning signal to the control unit terminals. This failure is not signalled in the control unit. As soon as a main motor failure has been registered, the backup motor is automatically started. In case of such a backup, the air-handling unit will be switched to the STOP mode, which will be signalled acoustically as well as visually by the control unit in the standard way, respectively using optional external outputs of failure signalling (other than those used for the backup mode signalling)..

RECOMMENDATION:

- We recommend using REMAK control systems for back-up motors.

GENERAL PROPERTIES

Depending on the precise specification of the requirements for the filter type and its efficiency, or on the required assembly length, the selection can be made from the several following design types of filters: insert filter with interchangeable medium, metal filter, frame filter, grease filter, bag filter, compact filter or active carbon filter. The filters are offered in a range from G3 to F9 filtration classes. If a reduced cross-section exists in front of the filtration assembly, it is advisable to insert an empty chamber in front of the filtration assembly to increase the effectiveness of the filtration area.

ASSEMBLIES:

G3 to F7 class filters are fitted into the individual fields of the filtration wall and can be pulled out in the direction of the service side. The filters are replaced from the „dirty“ side (i.e. pressure face). Each insert is fixed with a rotary closer or in the mounting frames and sealed behind the perimeter frame, looking from the air-flow direction, so that the inserts are constantly pushed by the flowing air against the sealing. The insert and frame filters are inserted into the slide-in rails insert by insert. If it is not possible to ensure enough space (= unit width) on the service side, e.g. if a catwalk with a railing is used, or access to the assembly is restricted, e.g. the assembly is situated in the upper branch and handling the removed filtration wall could be dangerous, it is necessary to insert in front of the filtration assembly an access chamber to enable replacement of the inserts inside the unit (see figure). The compact filter (M6 or F9 filtration class) and bag filter (F8 filtration class and higher) assemblies in the flat air-handling units 8 or 9 modules in width and air-handling units 6 modules in height are fixed and access from inside the unit must be ensured. The filtration bags are described in the installation manual of the AeroMaster Cirrus air-handling units.

MODULES		A	E	FILTER INSERTS	
WIDTH	HEIGHT	Internal width	Internal height	592 × 592	287 × 592
6	4	1893 mm	1227 mm	6	
7	4	2199 mm		6	2
8	4	2505 mm		8	
9	4	2811 mm		8	2
4	6	1281 mm	1839 mm	6	
5	6	1587 mm		6	3
6	6	1893 mm		9	
7	6	2199 mm		9	3
8	6	2505 mm		12	
9	6	2811 mm	2450 mm	12	3
6	8	1893 mm		12	
7	8	2199 mm		12	4
8	8	2505 mm		16	
9	8	2811 mm		16	4

Note: The inner height and inner width are internal dimensions of the chamber and correspond to the filtration wall dimensions. Please respect these dimensions when selecting the sliding wall!

FILTER TYPE	FILTRATION CLAS	FILTER INSERT LENGTH	NET ASSEMBLY LENGTH
insert filter	G3	96 mm	204 mm
frame filter	G4	96 mm	204 mm
frame filter	M5	96 mm	204 mm
bag filter	G3	200 mm	306 mm
bag filter	G4	300 mm	408 mm
bag filter	M5	360 mm	408 mm
bag filter	M6-F7	550 mm	612 mm
bag filter	F8-F9	550 mm	714 mm
compact filter	M6-F9	300 mm	510 mm
metal filter	G3	25 mm	102 mm
grease filter with a tray	G3	25 mm	204 mm

MAINTENANCE PRINCIPLES TO CONSIDER WHEN DESIGNING THE FILTRATION ASSEMBLY

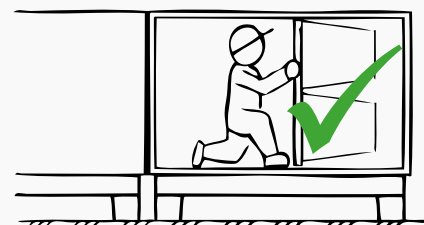
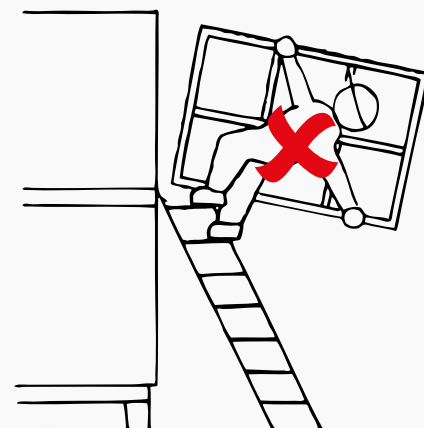
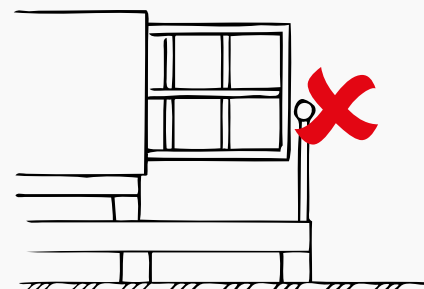
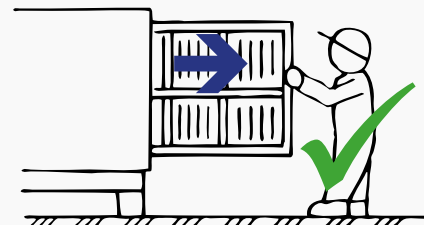

FILTER GROUPS, PROPERTIES AND TYPICAL EXAMPLES OF APPLICATION

FILTRA- TION CLASS	PROPERTIES AND RECOMMENDED USE	MEAN RATE OF SYNTHETIC DUST SEPARATION AS PER EN 779* (%)
G – COARSE DUST FILTERS		EFFECTIVE FOR PARTICLES > 10 µm
G1** G2**	<ul style="list-style-type: none"> ■ only for simple applications ■ effective for coarse and fibrous particles ■ application examples: protection against insects, capture of sand, coarse fly ash, water drops, textile fibres, hair and fuzz, leaves, etc. ■ pre-filters for higher dust concentrations 	G1: Am < 65 G2: 65 < Am < 80
G3 G4	<ul style="list-style-type: none"> ■ protection of air-handling devices against contamination; heat exchangers, humidifiers and fans ■ effective against dust, fly ash and pollen ■ filtration in applications for garages, department stores and sports halls; filtration of discharged air from paint spray booths or kitchens ■ pre-filters for F7 and F8 filtration classes (necessary only for heavily contaminated inlet air) and circulating air filters 	G3: 80 < Am < 90 G4: 90 < Am
M – MEDIUM DUST FILTERS		EFFECTIVE FOR PARTICLES > 1 µm
M5 M6	<ul style="list-style-type: none"> ■ outdoor air filters for less demanding rooms (e.g. workshops, sales and storage premises, garages, meeting rooms, sports halls, restaurants) ■ in industry, for plants requiring higher level of cleanliness (chemical and paper industry, less demanding precision engineering plants, etc.) ■ effective for air-borne dust particles PM10 (aerosol particles below 10 µm) ■ partially effective against spores and larger bacteria ■ poorly effective against soot, oil mist and tobacco smoke and smoke emissions from technological processes ■ pre-filters (F5) for F8 and F9 filtration classes; pre-filters (F6) for F9 and H10 filtration classes 	M5: 40 < Em < 60 M6: 60 < Em < 80
F – FINE DUST FILTERS		EFFECTIVE FOR PARTICLES > 1 µm
F7	<ul style="list-style-type: none"> ■ after-filters in middle level demanding air-handling systems, e.g. department stores a groceries, offices, wards, theatres, kitchens, specific production facilities and laboratories ■ in industry, for telephone exchanges, food production, precise engineering and optics workshops, TV and broadcast studios, air inlet to paint spray booths ■ effective against bacteria and spores, cement dust, through lungs dust, dust particles PM2.5 ■ partially effective against soot, oil mist and tobacco smoke and smoke emissions from technological processes ■ pre-filters for H11 and H12 filtration classes ■ pre-filters for absorption filters (e.g. active carbon filters) 	F7: 80 < Em < 90
F8 F9	<ul style="list-style-type: none"> ■ after-filters (2nd filtration stage) in more demanding air-handling systems, e.g. offices, switch rooms, laboratories, computer rooms ■ air-inlet systems in hospitals, operating theatres, auxiliary rooms of sterilizing stations and operating theatres, testing laboratories, chemical and pharmaceutical production plants ■ very effective against soot, oil mist and tobacco smoke (coarse fractions) and smoke emissions from technological processes (coarse fractions) and bacteria ■ pre-filters for H13 and H14 filtration classes ■ pre-filters for absorption filters (e.g. active carbon filters) ■ pre-filters for pharmaceutical industry (certification regulations must be observed) 	F8: 90 < Em < 95 F9: 95 < Em

* For valid CZ issue of ČSN EN 779:2012, for EU EN 779:2011, ** G1 and G2 are not included in the REMAK offer.

WOVEN FILTER INSERTS

These are designed to protect an air-handling device against contamination and coarse dust. They are used for single-stage air filtration in simpler air-handling systems or as pre-filters before filters of a higher filtration class, and thus they help to extend their service life and reduce operating costs.

The filter insert is made of thermally and mechanically reinforced 100% polyester textile which is stretched between aluminium braces in a metal frame.

The insert is pushed into a guiding frame. Access to the insert is provided by the inspection door.

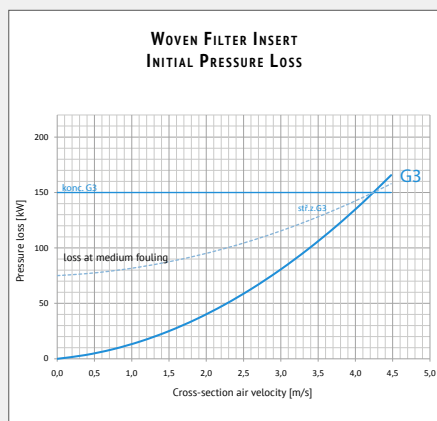
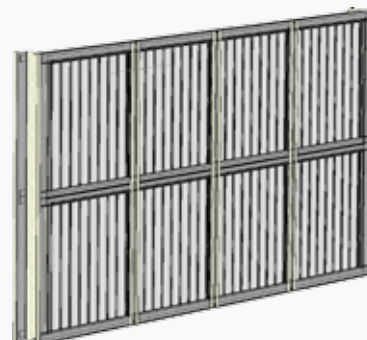

Filtration class:

- G3

End pressure loss recommended by the manufacturer¹:

- 300 Pa

End pressure loss recommended by the manufacturer, filter² (EN13053:2006 E):

- G3 150 Pa

Maximum heat resistance of the filter:

- 100 °C

Dimensional Range

METAL FILTERS

These filtration cells are especially used as pre-filters to catch high concentrations of the largest dust particles (foundries, metallurgical works, desert areas etc.)

The metal filter assemblies are fitted with 25 mm thick G3 filtration class metal filter inserts.

The reclaimable metal filter insert consists of an aluminium frame in which a filtration screen made of special interlaced aluminium wire is fitted. The front and rear side of the filter is protected by a firm screen made of expanded aluminium lath.

DESIGN VARIANT

- stainless steel filter variant

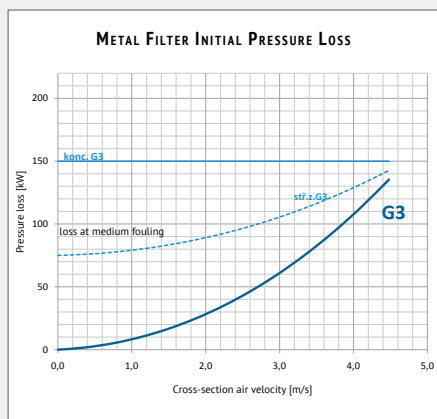

Filtration class:

- G3

End pressure loss recommended by the manufacturer:

- 150 Pa

End pressure loss recommended by the manufacturer, filter (EN13053:2006 E):

- 150 Pa

Maximum heat resistance of the filter:

- 100 °C



1. The end pressure loss recommended by the manufacturer is intended as the maximum (design) pressure loss down to which the filter can be operated.
2. The recommended filter final pressure loss is recommended by EN 13053 in relation to operating economy.



FRAME FILTERS

These are designed to protect an air-handling device against contamination and coarse dust. They are used for single-stage air filtration in simpler air-handling systems or as pre-filters before filters of a higher filtration class, and thus they help to extend their service life and reduce operating costs. The frame filter is made of pleated filtration medium fitted into a reinforced cardboard frame. The insert is pushed into a guiding frame. Access to the insert is provided by the inspection door.

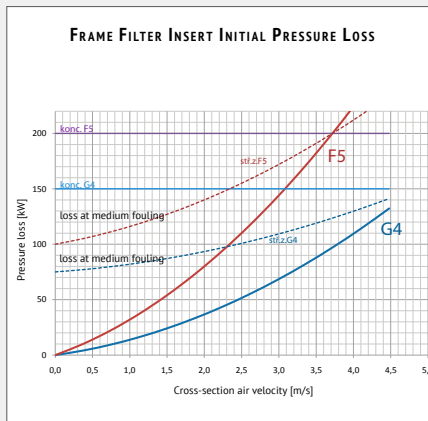

Filtration class:

- G4–M5
- End pressure loss recommended by the manufacturer:
- 300 Pa
- End pressure loss recommended by the manufacturer (EN13053:2006 E):
- G4 150 Pa
- F5 (M5) 200 Pa
- Maximum heat resistance of the filter:
- 70 °C



BAG FILTERS

These bag filters are designed for the 1st to 3rd filtration stage depending on the used filtration textile. The bag filtration inserts are made of unwoven polyester textile with high absorption capacity fitted into a plastic frame.

Note: The bag filtration inserts cannot be regenerated so they must be replaced when they reach the limit pressure loss.

Filtration class:

- G3–F9
- End pressure loss recommended by the manufacturer:
- G3–G4 250 Pa
- F5 (M5), F6 (M6) 400 Pa
- F7–F9 400 Pa
- End pressure loss recommended by the manufacturer (EN13053:2006 E)
- G3–G4 150 Pa
- F5 (M5), F6 (M6), F7 200 Pa
- F8–F9 300 Pa
- Maximum heat resistance of the filter:
- 70 °C

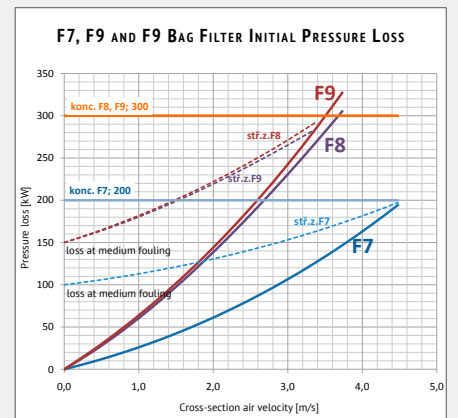
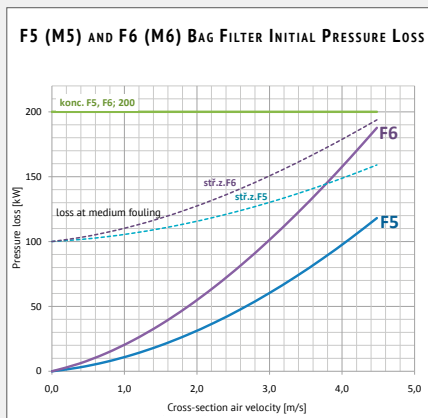
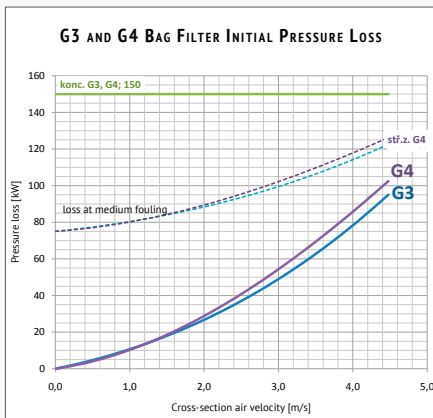

COMPACT FILTERS

These compact filters are designed for the filtration of dust; they separate fine dust particles and aerosols from the air. They are suitable for normal as well as special applications with increased service life and variability requirements. They are used in the air-handling unit as post-filters or pre-filters of filters for micro-particles.

Compactness (arbitrary options of the flow direction and fitting position), shorter assembly, large filtration area (triple that compared to bag filters) and thus significantly longer service life are the main advantages of these filters. Inserts are made of a submicron glass fibre fabric set in a compact self-contained plastic frame. The compact filters can be used for higher volume air-flow rates (can withstand higher air-flow speeds, maximum end pressure loss can reach up to 800 Pa).

The compact filters are offered in a range from M6–F9 filtration classes. They can be fitted in mounting frames or sliding walls. The filters are always replaced from the „dirty“ side.

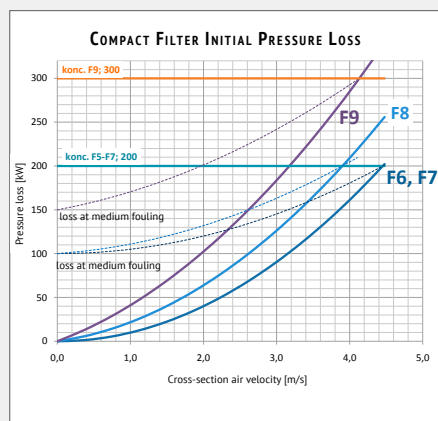
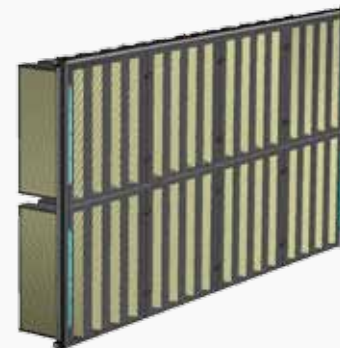

Filtration class:

- M6–F9

End pressure loss recommended by the manufacturer:

- 450 Pa

End pressure loss recommended by the manufacturer (EN13053:2006 E):

- F5 (M5), F6 (M6), F7 200 Pa
- F8, F9 300 Pa

Maximum heat resistance of the filter:

- 60 °C

GREASE FILTERS

These filtration cells are especially used to catch grease and oil aerosols at the outlet from bakeries, kitchens, grills, etc. The grease filter assemblies are fitted with 25 mm thick G3 filtration class metal filter inserts. The reclaimable metal filter insert consists of an aluminium frame in which a filtration screen made of special interlaced aluminium wire is fitted. The front and rear side of the filter is protected by a firm screen made of expanded aluminium lath. The grease filter assembly is also equipped with a stainless tray to catch the separated waste particles (grease, oils). The tray is an integral part of the filter insert and can be removed along with the insert and cleaned. Once removed from the assembly, the filters can be cleaned by washing in hot water (max. 80°C) with detergent. This filter can also be delivered in a stainless steel version.

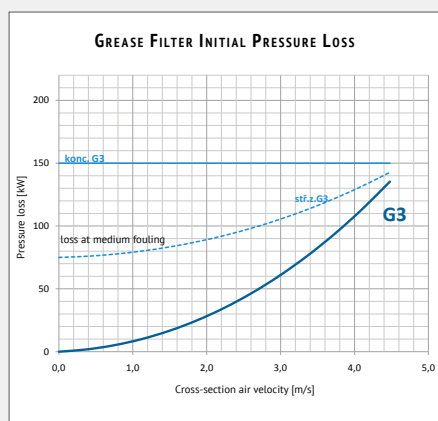

As the metal filters are not able to separate the finest aerosol drops, it is necessary to use additional filtration stages in those assemblies containing a plate or a rotary heat exchanger to avoid fouling of the heat-exchanging surfaces. The correct selection of a suitable filtration class for these additional stages depends on the specific application and the customer's requirements. As a basic solution, the following assembly is recommended: grease filter + G4 filter + F7 filter.

Filtration class:

- G3

End pressure loss recommended by the manufacturer:

- 150 Pa

End pressure loss recommended by the manufacturer (EN13053:2006 E):

- 150 Pa

Maximum heat resistance of the filter:

- 100 °C



ACTIVE CARBON FILTERS

These filtration assemblies are fitted with an active carbon filtration system. Shaped carbon pellets with a large filtration surface (up to 1250m² per gram of active carbon) are enclosed in the cartridges and evenly positioned in the mounting frame. The standard cartridge length is 450 mm (625 mm on request). Active carbon cartridges need to be ordered for a specific application, i.e. it is necessary to know the gas composition. The carbon can be untreated (for common gases) or impregnated to filter hard to absorb gases (like ethane, methane, ammonia and carbon dioxide). The fouling rate is checked by regular weighing of the cartridges. For that purpose, it is advisable to keep records. The cartridge service life, i.e. the maximum absorption capacity, equals the maximum weight increment (see the table below), which depends on the composition and concentration of harmful gases as well as on the operating time. When the maximum absorption capacity has been reached, the cartridges must be reactivated. As the complete cartridge must be reactivated, it is advisable to possess a spare set of filter cartridges. Active carbon containing toxic substances, radioactive impurities or PCBs cannot be reactivated! The net weight of one 450 mm long cartridge refill is 2000 g while the total weight of the filled cartridge is 2500 g. When designing or projecting, the following principles must be followed:

- Active carbon is very sensitive to dust; therefore, effective pre-filters of min. EU7 filtration class must be used.
- To filter off dust from the active carbon, it is advisable to place another EU7 filter after this assembly.
- The filtered harmful pollutants must be adsorbable.
- To select the proper active carbon type, it is necessary to know the composition and concentration of the harmful pollutants.
- The pressure loss is increased in the active carbon and stays constant.
- Standard filter cartridges absorb organic hydrocarbons and odours.
- Specially designed filter cartridges can absorb: ammonia and acid vapours from the air; formaldehyde and phosphates from the air, mercury and amines from the air and gases; radioactive methyl iodide
- If various harmful substances are to be filtered, it is necessary to use multistage filtration with suitably impregnated active carbon.

USE OF UNTREATED (STANDARD) ACTIVE CARBON		
Group # 1	Group # 2	Group # 3
very good adsorption, 20-50% of AU weight	good adsorption, 10-18% of AU weight	very small or no adsorption ability, 0-8% of AU weight
toluene, xylene, petrol, phenol, benzene, perchlorethylene, styrene, acetates, kerosene, turpentine, kitchen odour, smoke-box and meat industry odours, harmful welding gas, sewage treatment plant odours, body odour, adhesive and brazing harmful gas, tobacco smoke, hospital odours, disinfectants, benzol	ether, anaesthetics, acetone, methyl alcohol, phosgene, acetates, smog gases	acrolein, ethane, propane, ethylene, chlorine, methane, ammonia, carbon dioxide, amines, alkaline and acid vapours, HCl, SO ₃ , NO _x , sulphates, hydrogen sulphides, organic sulphur compounds, formaldehydes, mercury vapours, radioactive methyl iodide and phosphanes. Note: In these cases, it is necessary to use impregnated AU

COMBINED ASSEMBLIES

Combined filter assemblies can be used to save space:

- G3 metal filter and (G3-F9) bag filter
- G3 metal filter and (M6-F9) compact filter
- G3 insert filter and (G3-F9) bag filter
- G3 insert filter and (M6-F9) compact filter
- Two compact filters (e.g. F7 filter + active carbon filter to filter off common odours)

Examples:

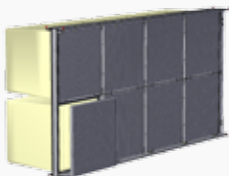

G3 metal filter + F7 bag filter

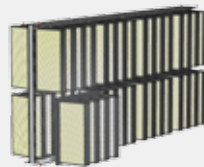

M6 compact filter + F9 compact filter



G3 insert filter + F8 bag filter

WATER HEATERS

As standard, the frame of the heater is made of galvanized sheet steel. The exchanger block is made of copper tubes and aluminium fins. The headers and connecting necks are welded from steel tubes and provided with an outer end thread and protective coating.

The header's (exchanger's) design always corresponds with the connection configuration

- Direct (through the panel)
- Into the unit's cross-section – used especially for outdoor versions, installation of the mixing set inside the unit's cross-section (empty space for the mixing set must be specified)

The headers are provided with brazed copper fittings with inner threads and plugs allowing exchanger drainage and installation of an air-venting valve and exchanger antifreeze protection sensor. The diameter of the fittings is 3/8". All heaters are tested underwater for leakage by compressed air; air pressure of 3.6 MPa, water temperature 10–30 °C.

Exchanger material and design options in accordance with the installation type:

- frame galvanized steel (epoxy coating), aluminium (Al Mg), stainless steel AISI 304 or AISI 316
- tubes copper
- fins aluminium with epoxy coating
- headers copper – outer thread

Max. temperature of the heating water 130 °C

Max. pressure of the heating water 1,6 MPa

The water heaters are installed on guiding rails which enable the exchanger to be slid out for cleaning and service (replacement).

RECOMMENDATION

- The heater must always be equipped with antifreeze protection elements.
- To ensure proper operation of the heater, it is necessary to install reliable air-venting, the best being an automatic valve.
- The heater must be counter-current connected (follow the information labels on the air-handling unit's casing).
- Always install a filter in front of the heater.

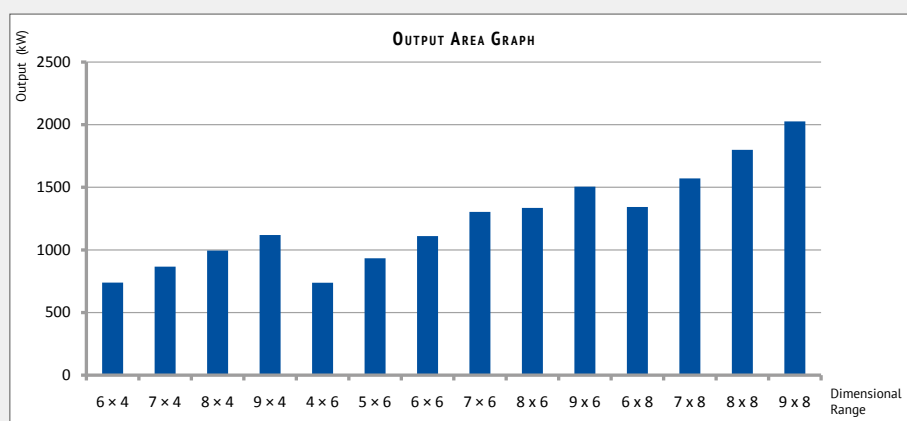

WATER PRE-HEATER

The water pre-heater's material and connection options are the same as with the heater. Greater spacing of the fins is the main difference, designed so that the air pressure loss will not be unnecessarily increased (e.g. by fouling of the fins).

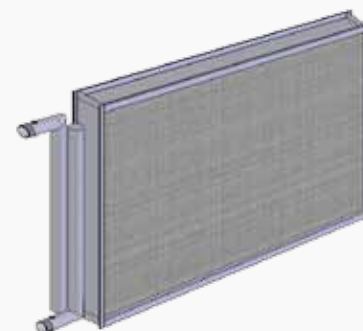

- Standard version



- Alternative version with internal connection

- The heaters and coolers are designed with minimum distance of the fins in accordance with EN 13053.
- The heater's fin spacing is 2.1 mm; the cooler's fin spacing is 2.5 mm.



■ Gas heater



■ Weishaupt pressure burner

GAS HEATER

CASING AND GAS HEATER LOCATION

The gas heater's casing is created by aluminium frame profiles and thermally insulated 50mm thick sandwich panels.

The air is heated by flowing around the flue gases-air heat exchanger. The heat exchanger consists of a combustion and tube exchanger. The combustion chamber and exchanger edges are fitted with leading sheets and fins to control the air flow through the exchanger's parts and to increase the heat-exchange area. All tubes are equipped with flue gas whirlers.

A flange for the burner mounting is situated on the front (service) side of the heater. The flue gases are drawn off via the chimney outlet (optionally on the rear side of the heater). Heaters are delivered in two versions with a bypass. This version is equipped with a flap controlling the air ratio flowing through the exchanger and through the bypass. This enables the temperature to be kept within 2 °C of the required value. Furthermore, the heater is equipped with a triple safety thermostat and a condensate draining outlet (1/2" pipe).

This heater can be delivered for indoor as well as for outdoor environments. The indoor version of the unit can only be used in basic environments in accordance with EN 330300. The heater and triple safety thermostat of the outdoor version are protected by covers.

BURNERS

As standard, Weishaupt pressure burners for natural gas are delivered with the heater. If propane-butane or LFO (Light Fuel Oil) is used, it is necessary to specify this requirement when processing the offer to allow us to modify the technical design and quotation.

As standard, the burners are delivered equipped with two-stage or modulation control. The burners include complete gas fittings, electrical controls and safety functions.

A burner operated in an outdoor environment must be provided with a heating cable switched by the thermostat. As standard, this set is included in deliveries marked as TKW 53 for burners WG 10, WG 20, or as TKW 88 for burners WG 30, WG 40.

CONNECTION

The gas heater block must be connected to the air duct via a dilatation insert heat resistant up to 200 °C.

The smoke flue is not included in the delivery. Safety and control elements delivered with the section must be connected to ensure proper, reliable and safe operation. Details are included in the table in the AeroMaster Cirrus Installation Instructions..

RECOMMENDATION

- When designing the air-handling unit, we recommend placing the gas heater section at the end of the inlet part of the air-handling unit.

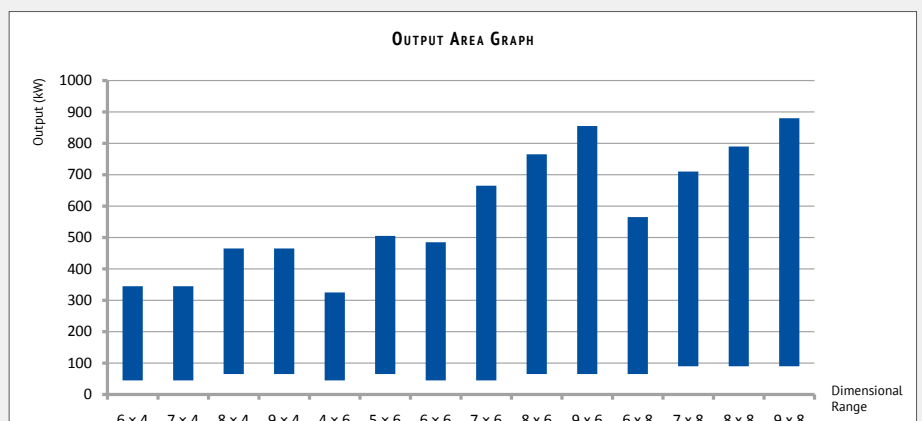

ELECTRIC HEATER

The electric heater frame is made of galvanized sheet steel.

Heat transfer is ensured by wrapped heating rods featuring a large heat exchange surface.

The electric heaters can be selected depending on the required type of control and control system:

- EO – basic type of electric heater whose individual heating output sections are brought out into the terminal box. These output sections are toggled between two positions (ON/OFF) switching the heating output of the given section (e.g. by the contactor in the control unit).
- EOSX – these heaters are designed for successive switching of individual sections using a suitable type of control unit.

These heaters are equipped with thermal protection depending on the heater type.

- As standard, the EO heater is equipped with a thermostat picking up the temperature of the casing and a thermostat picking up the temperature between the heating rods.
- The EOSX heater is in addition equipped with thermal protection of the heater's controls.

Connecting terminal boxes and thermal protection terminal boxes are situated on the heater's service side. Wiring grommets corresponding to the heater output and control type are situated on the air-handling unit casing (lower panel). In relation to the electric heater output and its connection by a suitable cable taking into consideration the cable's allowable bending radius, it is necessary to equip the unit with a base frame of a suitable height, or install it on a suitable bed frame. Calculation of the base frame height is automatically performed in AeroCAD design software.

The electric heaters are installed on guiding rails which enable them to be slid out for cleaning and service (replacement).

Supply voltage 3 NPE 400 V, 50 Hz.

Exchanger's design options in accordance with the installation type:

- Heater frame galvanized steel, stainless steel
- Heating rods stainless steel

RECOMMENDATION

- Maximum air flow velocity: 1.5 m/s
- Always install a filter in front of the heater.
- Switching off the heater must be combined with the fan run-out to allow sufficient cooling.

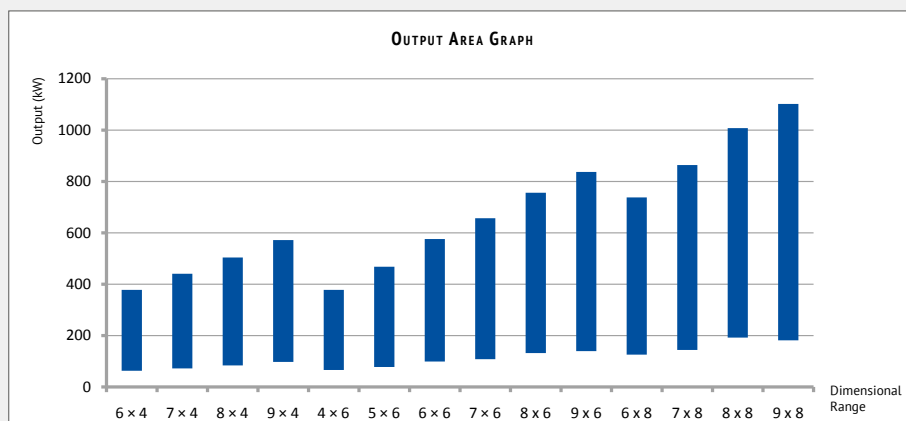

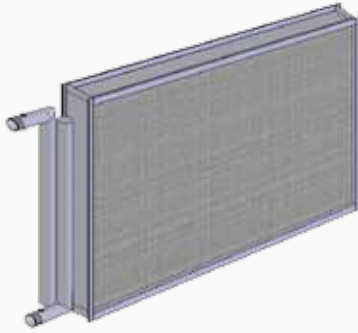

- Standard version

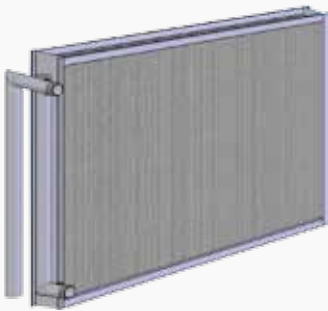

- Alternative version with internal connection

- The heaters and coolers are designed with minimum distance of the fins in accordance with EN 13053.
- The heater's fin spacing is 2.1 mm; the cooler's fin spacing is 2.5 mm.

WATER COOLER

This cooler is suitable for operation with water and coolant pumps.

As standard, the frame of the water heater is made of galvanized sheet steel. The exchanger block is made of copper tubes and aluminium fins.

The headers and connecting necks are welded from steel tubes and provided with an outer end thread.

The header's (exchanger's) design always corresponds with the connection configuration:

- Direct – through the panel
- Into the unit's cross-section – used especially for outdoor versions, installation of the mixing set inside the unit's cross-section.

The headers are provided with brazed copper fittings with inner threads and plugs allowing exchanger drainage and installation of an air-venting valve. The diameter of the fittings is 3/8".

All coolers are tested underwater for leakage by compressed air; air pressure of 3.6 MPa, water temperature 10 °C - 30.

Exchanger material and design options in accordance with the installation type:

- Frame galvanized steel (epoxy coating), aluminium (Al Mg), stainless steel AISI 304 or AISI 316
- Tubes copper
- Fins aluminium with epoxy coating
- Headers copper – outer thread

Max. pressure of the cooling water 1,6 MPa

The water coolers are installed on guiding rails which enable the exchanger to be slid out for cleaning and service (replacement).

The water cooler is equipped with a stainless condensate drainage tray and a drainage neck – tube of 32 mm diameter.

RECOMMENDATION

- To ensure proper functioning, it is necessary to fit the condensate drainage with a suitable siphon.
- It is advisable to place a drop eliminator behind the water cooler.

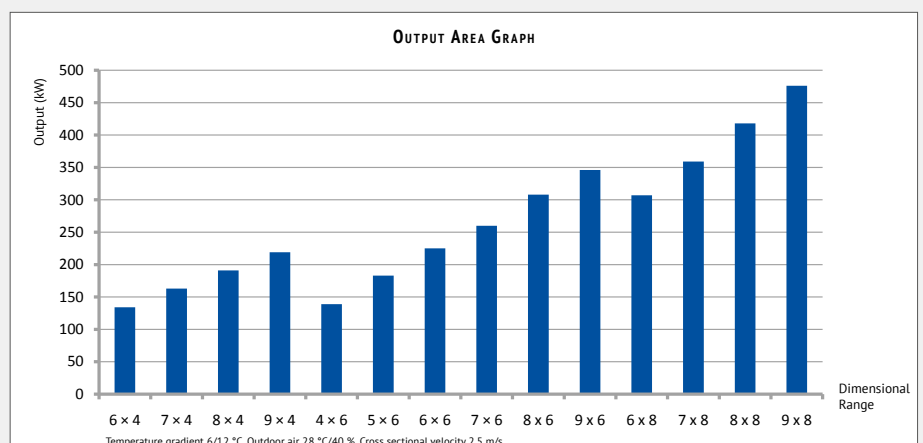

DIRECT EVAPORATOR

As standard, the frame of the direct evaporator is made of galvanized sheet steel. The exchanger block is made of copper tubes and aluminium fins.

The connecting necks are made of welded copper tubes in the following connection configuration:

- Direct – through the panel
- Into the unit's cross-section

The direct evaporator can be delivered with

- 1 circuit
- 2 circuits – for larger outputs or better cooling output control (output split 50/50%)

Exchanger's design options in accordance with the installation type:

- Frame galvanized steel (epoxy coating), aluminium (Al Mg), stainless steel AISI 304 or AISI 316
- Tubes copper
- Fins aluminium with epoxy coating
- Headers copper

The evaporator can be designed for the following coolant types – R718 (H₂O), R22 (CHClF₂), R123 (C₂HCl₂F₃), R314a (C₂H₂F₄), R152a (C₂H₄F₂), R404A (Mix), R407C (Mix), R410A (Mix), R507A (Mix)

The direct evaporators are installed on guiding rails which enable the exchanger to be slid out for cleaning and service (replacement).

The direct evaporator is equipped with a stainless condensate drainage tray and a drainage neck – tube of 32 mm diameter.

RECOMMENDATION

- To ensure proper functioning, it is necessary to fit the condensate drainage with a suitable siphon.
- It is advisable to place a drop eliminator behind the direct evaporator.

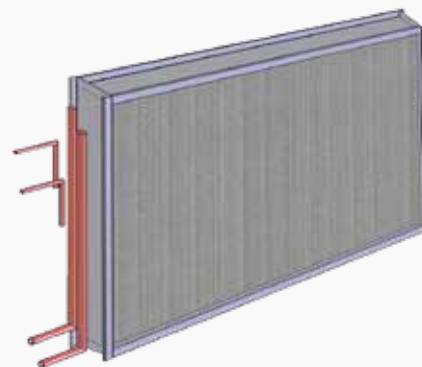

- The heaters and coolers are designed with minimum distance of the fins in accordance with EN 13053.
- The heater's fin spacing is 2.1 mm; the cooler's fin spacing is 2.5 mm.

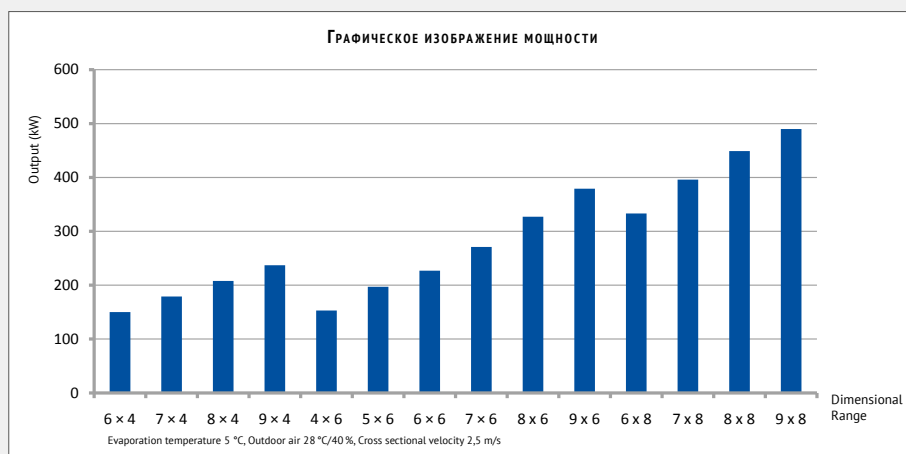



DESIGN VARIANTS

- Single-compressor design
- Double-compressor design

INTEGRATED COOLING

Compressor units along with optimized Remak exchangers serve as sources of cold for AeroMaster Cirrus and AeroMaster XP air-handling units.

CONFIGURATION

We can deliver either a fully operational unit with all the components (compressors, exchangers, etc.) of the compressor circuit interconnected and the piping filled with coolant so all you need to do is to switch the unit on, or a disassembled unit.

The unit assembly includes the necessary safety and control elements, separate distribution board and suitably dimensioned optional injection valves. Depending on the output, respectively on the requirement of the control level, the unit can be fitted with one or two compressors.

When designing the system, we only use quality components from approved suppliers.

CONTROL

- The unit's output can be controlled on several levels depending on its application.
- The unit's output is controlled by switching the compressor using an external signal, i.e. ON/OFF system. If a double-compressor arrangement is used, 0/50/100 % output control can be achieved by switching the compressors in sequence.
- If an electronic controller is used, the switching of the compressors is then controlled depending on the number of operating hours elapsed.
- If the Digital Scroll™ compressor is used, the refrigerating capacity will then be controlled within a given range steplessly.
- To avoid the whole system's efficiency being reduced, REMAK compressor units are antifreeze protected.

INTEGRATED COOLING ADVANTAGES

- Simplifies and makes air-handling unit commissioning cheaper
- Saves room (no need for installation of outdoor sources of cold)
- Saves operating costs, among others by creating suitable conditions for heat removal (high EER factor – energy efficiency factor)
- Simple, fast and cheap servicing (just one device)
- Minimum length of distribution pipes – minimum volume of coolant
- Low sound level transmitted to the surroundings
- Minimised damage in the event of failure (just one of the sources of cold is disabled)

INTEGRATED COOLING SYSTEM HAS SOME LIMITS:

- Limited output, especially due to limited condensation area and small difference between coolant and air temperatures
- higher pressure loss on the relief air side

REMAK SOLUTION ADVANTAGES

- customised solution without catalogue compromises
- option of economy or comfort solution
- simple and therefore failure-free design
- High efficiency due to:
 - minimised effective area of the exchangers
 - selection of suitable components in the circuit (injection valves, etc.)
 - system designed for optimum operating temperatures
- optional delivery of a „plug and play“ unit or a disassembled unit

KHX-S1 COMPRESSOR UNITS											
Model	Refrigerating capacity kW, R407C, Tc=+45 °C				Unit dimensions H×W×D (mm)	Weight kg*	Noisiness Lp dB(A)/10m	Voltage V/50Hz	Operating current max A	Distribution board	
	Evaporating temperature T _E									Dimensions	Weight
	+6°C	+9C	+12 °C	+15 °C			H×W×D (mm)			kg	
KHX-S1-4	4,2	4,7	5,3	5,9	540×400×415	32	34	230	7,4	407×304×148	5
KHX-S1-5	5,2	5,8	6,5	7,2	540×400×415	34	34	400	3,8	407×304×148	5
KHX-S1-7	6,7	7,5	8,4	9,3	540×400×415	37	34	400	4,7	407×304×148	5
KHX-S1-8	7,9	8,9	10,0	11,1	540×400×436	39	37	400	5,6	407×304×148	5
KHX-S1-9	9,4	10,5	11,8	13,1	540×400×450	40	37	400	6,3	407×304×148	5
KHX-S1-12	11,4	12,9	14,4	16,0	540×400×470	44	37	400	7,6	407×304×148	5
KHX-S1-14	14,8	16,4	18,2	20,2	540×400×490	44	41	400	9,1	407×304×148	5
KHX-S1-17	16,8	18,8	21,0	23,3	540×400×490	52	41	400	10,5	407×304×148	5
KHX-S1-19	19,1	21,4	24,0	26,8	540×400×490	52	41	400	12,8	407×304×148	5
KHX-S1-22	23,4	26,1	29,0	32,2	540×400×525	71	43	400	14,4	407×304×148	5
KHX-S1-25	26,2	29,3	32,7	36,3	540×400×582	73	43	400	15,5	407×304×148	5
KHX-S1-29	30,6	34,2	38,2	42,4	540×400×582	75	43	400	18,2	407×304×148	5
KHX-S1-33	35,1	39,3	43,8	48,6	540×400×582	87	44	400	20,1	500×400×240	17
KHX-S1-36	38,5	43,6	49,0	55,0	540×400×601	91	47	400	23,1	500×400×240	17
KHX-S1-43	44,8	50,2	56,0	62,2	690×400×601	97	49	400	29,2	500×400×240	19

KHX-S2 COMPRESSOR UNITS											
Model	Refrigerating capacity kW, R407C, Tc=+45 °C				Unit dimensions H×W×D (mm)	Weight kg*	Noisiness Lp dB(A)/10m	Voltage V/50Hz	Operating current max A	Distribution board	
	Evaporating temperature T _E									Dimensions	Weight
	+6°C	+9C	+12 °C	+15 °C			H×W×D (mm)			kg	
KHX-S2-38	38,2	42,8	48,0	53,6	690×500×494	106	44	400	25	500×400×240	19
KHX-S2-44	46,8	52,2	58,0	64,4	690×500×525	147	46	400	28,4	500×400×240	19
KHX-S2-50	52,4	58,6	65,4	72,6	690×500×582	152	46	400	30,8	500×400×240	19
KHX-S2-58	61,2	68,4	76,4	84,8	690×500×582	156	46	400	36,1	600×400×240	20
KHX-S2-66	70,2	78,6	87,6	97,2	690×500×582	156	47	400	40,3	600×400×240	20
KHX-S2-73	77,0	87,2	98,0	110,0	690×500×601	164	50	400	45,6	600×400×240	20
KHX-S2-87	89,6	100,4	112,0	124,4	690×500×601	169	52	400	58,2	700×500×280	23

* The weight includes the distribution board; applies for calculation of the units in ON/OFF versi

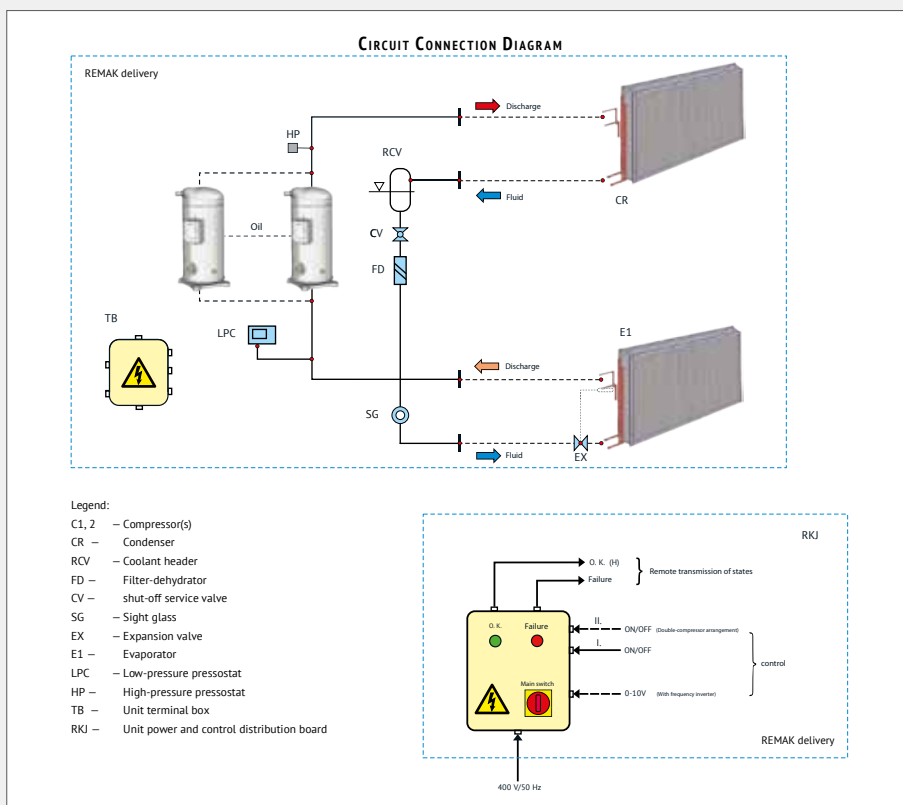

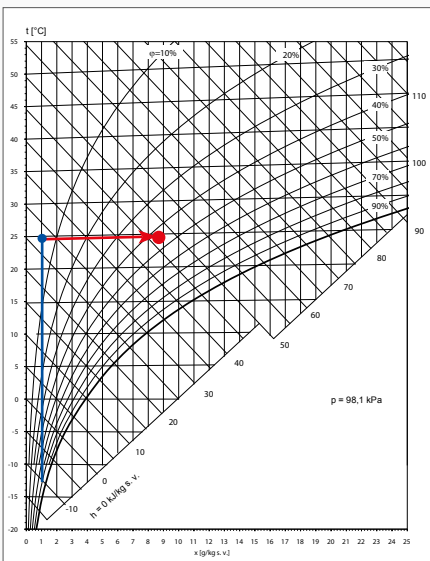

GRAPH DESCRIPTION

- Steam isothermal humidification

ADVANTAGES:

- Hygienic operation
- No need for water treatment
- No need for inlet air pre-heating, thanks to the use of isothermal humidification
- Easy and fast control
- When using electrode steam generator, low investment costs

DISADVANTAGES:

- Energy requirement (up to 750 W per 1 kg/h of water steam) if an electrode steam generator is used
- Need for periodical replacement of the boiling drums
- Low control accuracy

STEAM HUMIDIFICATION

Steam humidification is a nearly isothermal process during which steam generated from boiling water is dispersed into the inlet air. As the steam temperature is higher than the air temperature, the air temperature tends to rise slightly (therefore „nearly isothermal process“).

The electrode steam generator uses drinking water (75 to 1250 $\mu\text{S}/\text{cm}$) and depending on the size covers outputs from 3 to 270 kg/h. For higher outputs, it is possible to select between electrode and more economical gas generators. The required steam output calculation and a suitable steam humidifier design can be made using AeroCAD design software, based on the input parameters.

The steam humidification assembly is equipped with a condensate drainage tray and a service door enabling easy and fast access to the tray and distribution tubes. If the order includes a steam humidifier assembly, the tubes are integrated into the casing. The standard assembly length is 1220 mm, including tray.

OPERATING CONDITIONS:

- 1–40 °C; 10–90 % rH; max. operating pressure 1500 Pa. The steam generator is not designed to be situated outdoors.
- Humidification control accuracy depends on the steam generation method. The electrode steam generator output is controlled by the water level in the generator drum while different operating cycles (e.g. operation – refilling – cooling – operation – drainage – intensive cooling – operation - ...) cause significant output variations. If air humidity is measured in the air duct leading from the ventilated room (duct sensor) or directly in the ventilated room (room sensor), an accuracy of ± 6 % rH can be achieved. If air humidity is measured in the inlet air duct, the variations will be greater. To ensure precise humidification control, resistance steam generators (ideally using demineralised water) or adiabatic humidifiers can be used.

ADDITIONAL RECOMMENDATIONS:

- The steam generator set includes a generator, distribution tubes, an inlet hose and a condensation hose (standard length of the hoses is 3 m). The number of tubes depends on the steam output. The steam generator can be ordered along with a set of replacement steam generating drums (replacement frequency is 1x per year or max. every 2500 hours).
- The steam generator can be mounted on the wall near to the humidification chamber (max. steam hose length is 4.0 m while max. vertical distance is 2.0 m). For installation and commissioning instructions, refer to the separate humidifier manual.
- The waste water has a high content of minerals and its temperature can be up to 100 °C.
- The waste water can be drained away.
- The water hardness must not exceed 22.5 °dH.
- The steam generator is controlled by the humidity sensor (ether room or duct sensor), which can be ordered along with a limiting hygrostat.
- For outdoor air handling units, it is advisable to situate the humidifier assembly in the air duct inside the building.

OPERATING VOLTAGE:

- AC 3 × 400V/50 Hz

ADIABATIC HUMIDIFICATION

Adiabatic humidifiers are some of the most economical humidification systems. As the air is cooled during humidification, this system can also be conveniently used for cooling in summer. On the other hand, in winter it is necessary to take into account the increased level of energy needed for humidified air heating and pre-heating (or post-heating). The humidifier must not be situated too close before the filter assembly or attenuator. For sanitary reasons, it is advisable to use at least F7 (EN 13 053) class filters for the first filtration stage.

ADIABATIC HUMIDIFICATION USING HONEYCOMB WATERING

Honeycomb watering humidification is based on the principle of natural water evaporation into the air. An evaporation honeycomb structure sprinkled with water provides a large area for water evaporation into the flowing air and thus increases air humidity to the required level. It is delivered with several thicknesses of evaporation honeycombs offering three levels of efficiency, 65%, 85% and 95%. This humidification system is almost free of moving parts. Alternatively, you can choose between the system with water circulation or without circulation, where the surplus water is drained away. Initial costs as well as operating costs for energy are very low. The system uses drinking water so there is no need for demineralised water.

The adiabatic humidifier assembly is equipped with a surplus water drainage tray and a service door enabling easy and fast access to the system. Minimum length of the assembly is 592–692 mm (depending on the efficiency level). However, we recommend creating a 100–800 mm long service space behind the assembly to enable servicing.

OPERATING CONDITIONS:

- 1–40 °C; 10–90 % rH. This system is not designed to be situated outdoors (there is a risk of freezing). The system calculation and design is always made in relation to the specific order, based on the input parameters.
- Humidification accuracy of the system depends mainly on the selected type of control, from simple ON-OFF control providing accuracy of ± 10% rH up to stepless control using a bypass providing accuracy of ± 1% rH.

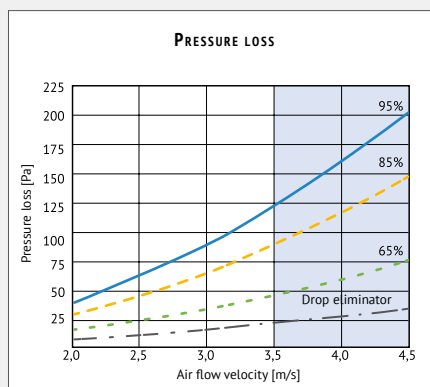
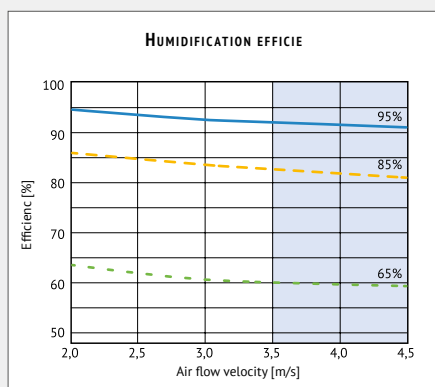

■ Honeycomb adiabatic humidifier

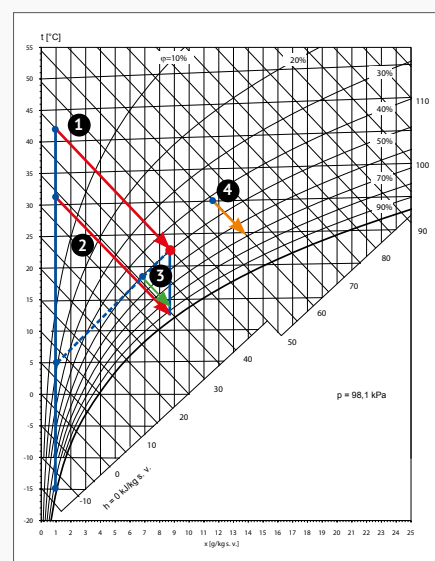

GRAPH DESCRIPTION

1. Adiabatic humidification in winter with pre-heating (less accurate humidification control)
2. Dry air adiabatic humidification in winter with post-heating (more accurate control using post-heating)
3. Economical version of humidification using air mixing and post-heating
4. Inlet air cooling in summer using adiabatic humidification

ADVANTAGES:

- No need for water treatment
- In summer, adiabatic humidification can be used for cooling
- Very low energy demand (50 W to 250 W)

DISADVANTAGES:

- Adiabatic humidification requires pre-heating or post-heating
- Higher weight
- Need to replace the honeycomb when deposits of minerals are exceeded

HEAT RECOVERY

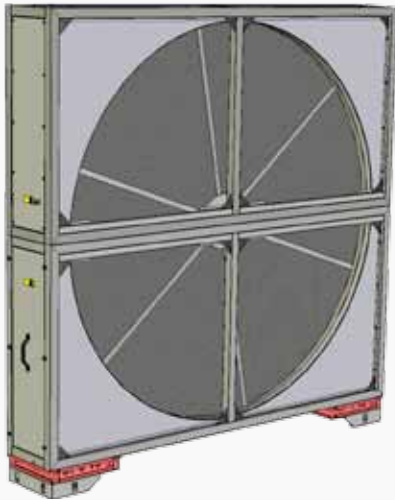

- Rotary regenerative heat exchanger for vertically arranged units

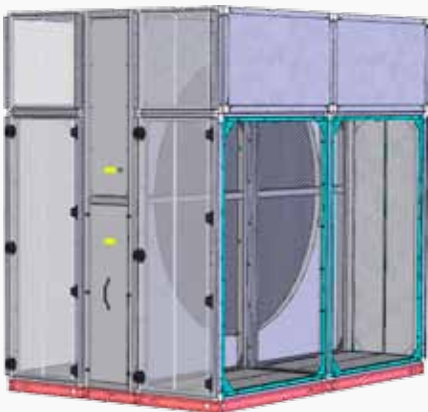

- Rotary regenerative heat exchanger for horizontally arranged units with height-levelling chambers

Example of heat recovery energy savings in relation to water heater capacity:

Recovered rotary heat-exchanger output of the Aero-Master Cirrus 9 × 4 air-handling unit

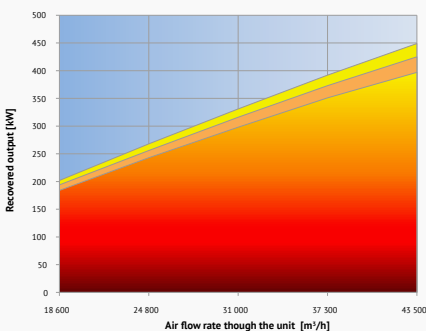

Valid for the following conditions:
-15°C/90% rH, +22°C/50% rH, rotor diameter 2590 mm

ROTARY REGENERATIVE HEAT EXCHANGER

This ensures heat and humidity (enthalpy version) transfer from the outlet air to the inlet air. Except for air flow velocity and air thermodynamic conditions, the heat transfer rate depends on the rotor geometry (especially on the rotor diameter and rotor wave height). The humidity transfer rate is given by the rotor's heat-exchange surface finish.

Maximum efficiency is up to 85% (valid for a wave height of 1.4 mm and air flow velocity close to 1 m/s).

The rotary regenerative heat exchangers are delivered in three heat transfer efficiency levels depending on the vane wave height:

- 1.9 mm (thermal efficiency up to 78 %)
- 1.6 mm (thermal efficiency up to 81 %)
- 1.4 mm (thermal efficiency up to 85 %)

The standard rotor made of aluminium foil (width of the winding 200 mm) has a limited ability to transfer humidity from outlet air to inlet air (humidity transfer only takes place when condensate is created). If humidity transfer is required, it is necessary to select the enthalpy rotor coated with a sorption layer enabling humidity transfer with 90% efficiency.

Humidity transfer can be affected by the rotor type selection:

- Thermal rotor (20% to 50% humidity transfer efficiency)
- Enthalpy rotor (40% to 80% humidity transfer efficiency)
- Sorption rotor (60% to 90% humidity transfer efficiency)

Heat recovery from the waste heat provides savings in operating costs while the investment return is max. 1 year. Humidity recovery from the outlet air is a very effective alternative to the additional inlet air humidification.

ROTARY REGENERATIVE HEAT EXCHANGER DESIGN

- The rotor is made of thin aluminium foil, while in the version for humidity transfer it has a sorption silica gel coating.
- Max. mixing of the inlet / outlet air due to leakage of the properly designed exchanger is 5%.
- A short-circuit armature asynchronous motor with a gearbox, belt drive of the rotor. Motor voltage AC 400V/50 Hz.
- Maximum air flow speed can be 4 m/s, special versions up to 6.0 m/s.
- The heat exchanger is designed to transfer air heat at temperatures ranging from -20°C to +55°C, or up to +100°C if made to special order.
- Operation at temperatures below -20°C is possible providing suitable antifreeze protection of the heat exchanger is ensured.
- A heat exchanger provided with a special epoxy surface finish can be delivered for highly aggressive environments (like coastal areas, etc.)
- On demand, especially for handling and transport reasons, the exchanger can be delivered with a split rotor and disassembled to some extent. The rotary regenerative heat exchanger rotor is always split for rotor diameters of 2950 mm and larger.
- The assembly is equipped with a removable panel on the operator's side to access the motor, optionally also with a sight glass.
- To extend the control range (using the XPFM frequency inverter and VCS control unit), the heat-exchanger drive is ready for 85 Hz. If another type of control is used or there is no control, the heat exchanger is delivered with a drive ready for 50 Hz. Operation using 18-85 Hz frequencies allows the rotor speed to be lowered to a range with a noticeable reduction in heat-exchange efficiency and smooth transition to the shutdown state. This is achieved by a power supply using 85 Hz frequency and a smaller pulley so that the maximum rotor speed remains in the optimum range of 10-13 rpm.

HEAT RECOVERY

PRESSURE GRADIENT	FLUSHING CHAMBER FUNCTION
0–200 Pa	Flushing chamber function not guaranteed
200–800 Pa	Effective flushing chamber function
more than 800 Pa	Use of the flushing chamber function is not recommended

RECOMMENDATION

- Inlet and outlet air for the heat exchanger must be filtered to avoid fouling of the rotor’s cells. The rotary regenerative heat exchanger has a limited self-cleaning capacity. Therefore, it is necessary to regularly check the rotor for fouling and if necessary, immediately clean the exchanger’s effective surface to avoid rotor destruction. Therefore, it is advisable to situate an assembly which enables service access (like service assembly, filtration assembly, etc.) from both sides of the rotary regenerative heat exchanger. The service space must be sufficient.
- In winter conditions, humidity from the inlet air is transferred to the outlet air during heat recovery. Water condensate created on the rotor is usually completely absorbed by the inlet air. If extreme humidity on the heat exchanger’s rotor is expected, the heat exchanger can be fitted with a collecting tray for condensate drainage; a special order has to be placed. At very low temperatures (below -15°C), when the outlet air temperature drops to -10°C after transferring its heat, there is the risk of excess humidity (which the inlet air is not able to absorb) freezing. This risk increases with higher humidity or lower temperature of the outlet air. These conditions can be avoided for example by heat exchanger control (rotor speed reduction), suitable mixing, heating, etc. Otherwise, there is the risk of irreversible destruction of the rotor caused by the limit exceeding pressure drag of the heat exchanger.
- In summer conditions, the inlet air is usually warmer and lighter than the outlet air so heat and humidity transfer is reversed. This condition can be used to achieve a significant cooling effect.
- If the rotary regenerative heat exchanger assembly is used in a horizontally arranged air-handling unit, an empty service chamber must be situated in front of the rotary regenerative heat exchanger assembly to extend the cross-section to the entire rotary heat exchanger’s height. Otherwise, the restricted cross-section significantly reduces the rotor’s heat-exchange effective area resulting in lower heat recovery efficiency.

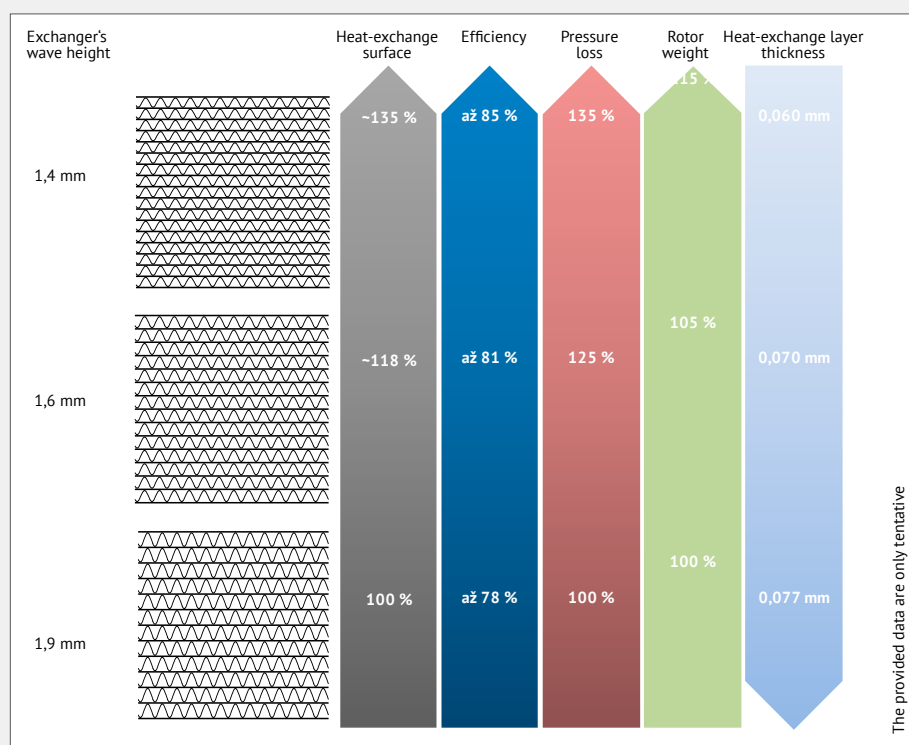

Humidification efficiency (%) in relation to the air-flow velocity (m/s) and rotor type

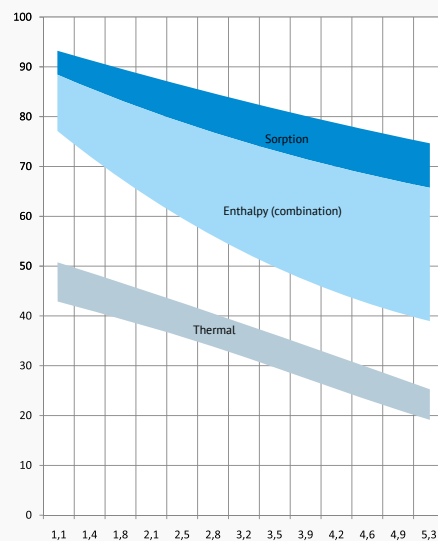

Pressure loss (Pa) in relation to the air-flow velocity (m/s) and rotor type

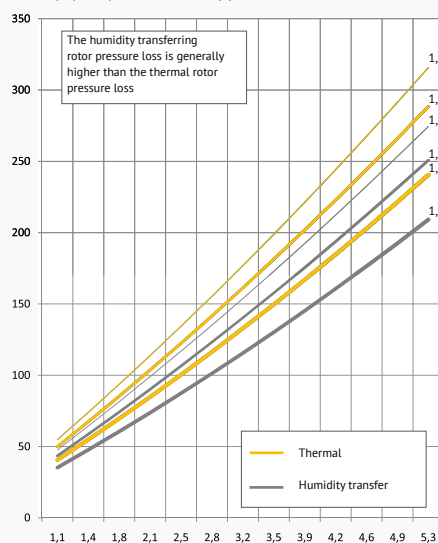

Thermal efficiency (%) in relation to the air-flow velocity (m/s) and rotor type

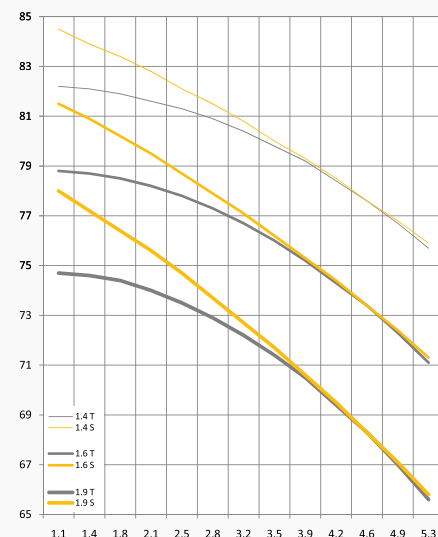



PLATE HEAT EXCHANGER

The plate heat exchanger assembly ensures heat transfer from the outlet air to the inlet air using a cross-airflow exchanger.

The investment return is max. 1 year.

Thanks to the separated air flows, it is an ideal solution for clean rooms.

This assembly can alternatively be equipped with a damper to create partial recirculation of the outlet air back to the inlet.

Maximum efficiency is up to 70% (if $V_e = V_p$).

The heat-exchange surface is made up of aluminium fins.

The plate heat exchanger can be delivered in a vertical version for vertically arranged air-handling units or in a horizontal version for horizontally arranged units.

THIS ASSEMBLY CAN BE DELIVERED IN THE FOLLOWING VERSIONS:

- without a bypass
- with a bypass
- with a bypass and mixing

- A version with a centre bypass, which enhances the air-flow characteristics, can be delivered for unit sizes above 5 width modules (for vertical version) or for unit sizes of 6 or more height modules (for vertical version).
- An epoxy coating surface finish can be selected for all delivered sizes.
- The bypass version is equipped with regulating dampers fitted on a common shaft. Both the bypass damper actuator and mixing damper actuator are always situated on the damper inside the exchanger. The bypass dampers are controlled by actuators working in proportional or discrete modes; the suitable type can be selected in the design program.
- A split version of the exchanger can be delivered on special demand. This version will always be delivered if the size exceeds standard transport dimensions.

RECOMMENDATION

- When installing the plate heat exchanger, the differential pressure in the exchanger must not exceed 2.0 kPa (2.5 kPa).
- It is always advisable to install a filter in front of the heat exchanger to protect the heat-exchange inserts from fouling.
- As condensate can be created during the heat exchange process, the inlet as well as outlet air branch of the plate heat exchanger can be fitted with a condensate drainage tray and depending on the air-flow velocity also with a drop eliminator. The risk of condensation can arise mainly in the winter season when the inlet air temperature drops below freezing point. The condensate drainage tray is fitted with a drainage neck of 32 mm diameter. A suitable siphon can be delivered as an accessory.
- In the winter season at very low temperatures (below -15°C), when the outlet air temperature can drop below zero after transferring its heat, there is the risk of excess humidity freezing, starting in the „cold“ corner of the exchanger. Though this process cannot damage or destroy the plate exchanger, the pressure loss will increase while the air flow rate will decrease. In extreme cases, the plate exchanger can completely freeze. These conditions can be eliminated by using suitable antifreeze protection, e.g. by measuring the temperature behind the exchanger or checking the exchanger's pressure loss in conjunction with the bypass damper state evaluation and control.

GLYCOL CIRCUIT

The glycol circuit is used to recover heat from the outlet air. The advantage of this method is 100% separation of both air streams and the possibility to install the air-handling unit inlet and outlet ducts in different (sometimes even distant) locations.

Ideal solution for clean rooms.

Two exchangers, a cooler and a heater are the basic elements of the circuit. The exchanger situated in the outlet air flow takes off the heat and acts as a cooler. It includes a drop eliminator and a stainless condensate drainage tray with a connection neck. The exchanger situated in the inlet air flow radiates the heat and acts as a heater. Glycol heat exchangers are designed as standard water heat exchangers intended for AeroMaster Cirrus air-handling units. The exchangers are interconnected by ducting and equipment which ensures control and safety functions. (The duct system elements and circulation pump are not included in the Remak delivery.)

A solution of ethyl glycol and distilled water is mostly used as the heating media to eliminate freezing. A mixing ratio suitable for the glycol circuit operating conditions can be determined using the design software.

As standard, the glycol circuit heat exchangers are counter-current connected.

Minimum media temperature depends on the glycol density.

As condensate can be created on the outlet exchanger, this exchanger can be fitted with a condensate drainage tray and depending on the air-flow velocity also with a drop eliminator.

MAXIMUM RECOMMENDED AIR FLOW VELOCITY

- Heater 3,8 m/s
- Cooler 2,8 m/s

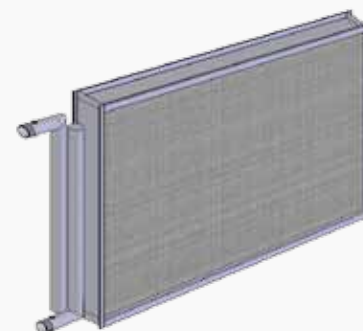
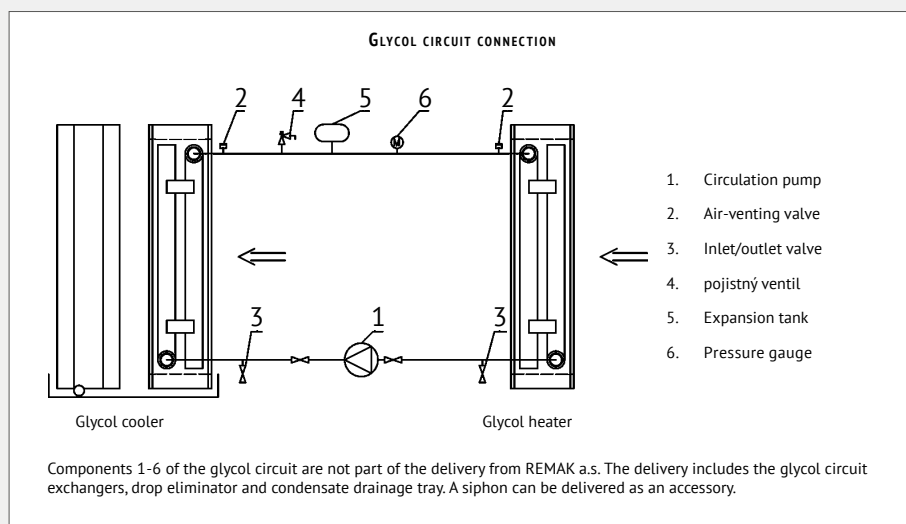

■ Standard version



■ Alternative version with internal connection

NOISE ATTENUATION

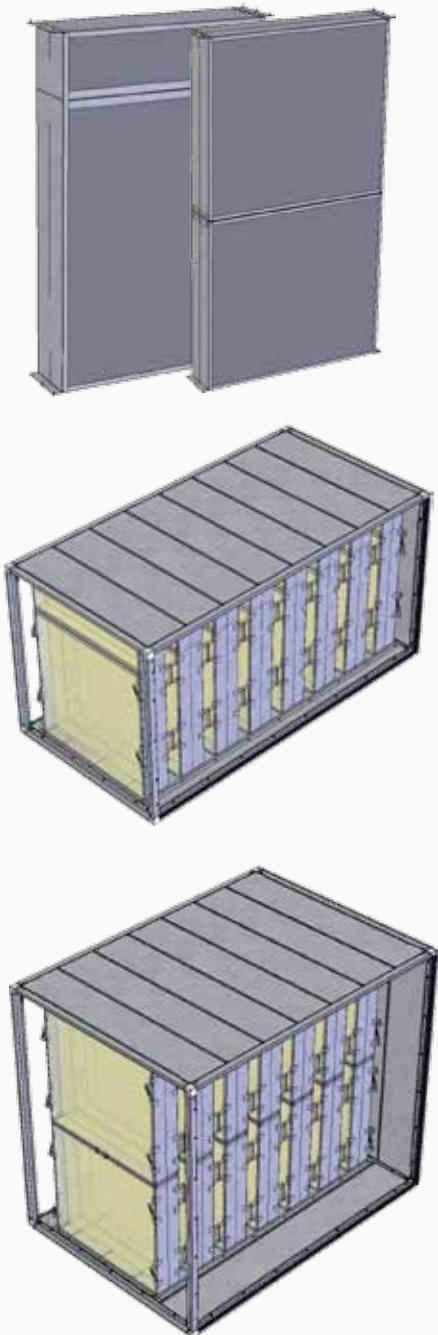

NOISE ATTENUATORS

Splitter attenuators are intended for attenuation of the noise transmitted from the fans through the air-handling duct in both the inlet and outlet.

MATERIALS AND DESIGN:

The splitters are made of galvanized sheet steel and filled with 200 mm thick insulation plates covered with unwoven textile on both sides. The attenuators with a height of 4 modules are produced from one-piece splitters while the attenuators with a height of 6, 7 and 8 modules are produced from two-piece splitters to make it easy to install them.

VARIANTS AND DESIGNS:

The splitters are produced in lengths of 500 mm, 750 mm and 1000 mm.

RECOMMENDATION:

The minimum distance between the splitters and other components against the air-flow direction is 200 mm while in the air-flow direction it is 300 mm.

The splitters are designed to provide effective attenuation at all frequencies emitted by the fans.

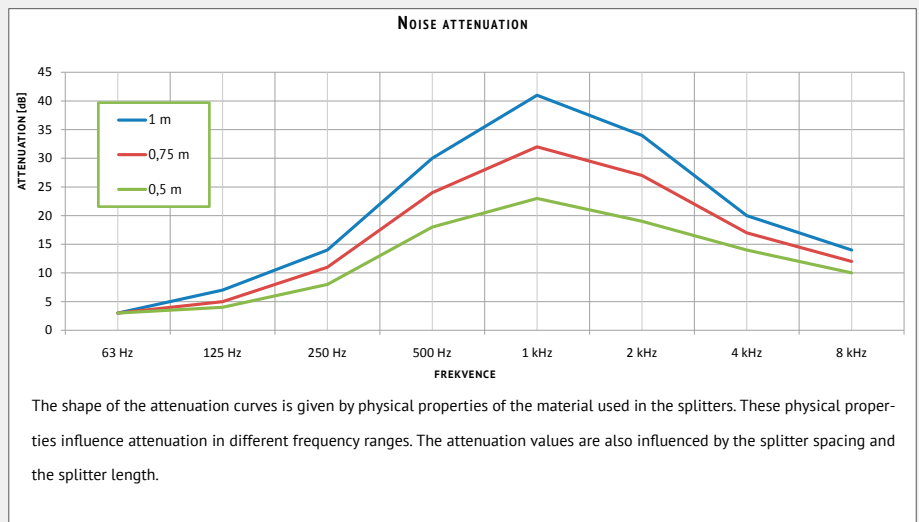

MIXING CHAMBER

This ensures mixing of the inlet and outlet air at a required ratio.

PARAMETERS:

The mixing can be adjusted within the range from 0 to 100%.

The AeroMaster Cirrus air-handling unit allows the following mixing combinations:

■ Face opening × side opening



■ Face opening × upper (or lower) opening



■ Side opening × side opening



CORNER CHAMBER

This serves as an auxiliary component for the following purposes:

- Side (left or right), upper or lower air inlet into the air-handling unit
- Side (left or right), upper or lower air outlet from the air-handling unit
- Fitting the inlet/outlet opening with an internal damper (suitable for outdoor applications)

The chamber can be fitted with a service panel to enable easy access to the internal damper actuator.

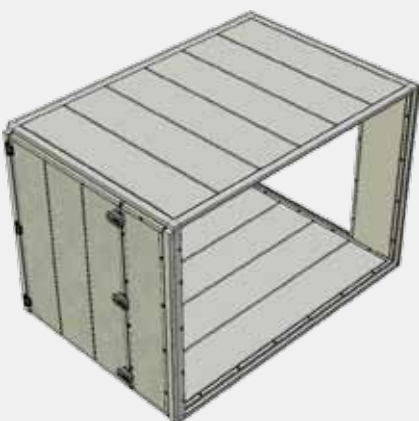

ACCESSORIES

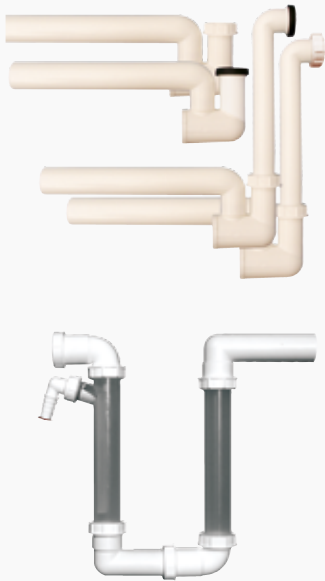

SIPHONS

Standard versions of the AeroMaster Cirrus air-handling units can be fitted with two types of siphons depending on the application type. Both siphon types are equipped with connections with dimensions in accordance with DN32 for the tray connection and DN40 for the pipeline connection. The siphon heights can be adjusted (see figure).

The siphon height corresponds to the pressure conditions inside the air-handling unit (fan static pressure).

- The siphon with a disconnecting trap (ball) is intended for negative pressure applications.
- This siphon is designed for maximum negative pressure of 2300 Pa at dimension A = 250 mm.
- The standard siphon is intended for overpressure as well as negative pressure applications. This siphon must be filled with water before putting it into operation.
- This siphon is designed for maximum overpressure of 2300 Pa at dimension A = 250 mm.
- This siphon is designed for maximum negative pressure of 1200 Pa at dimension A = 130 mm.

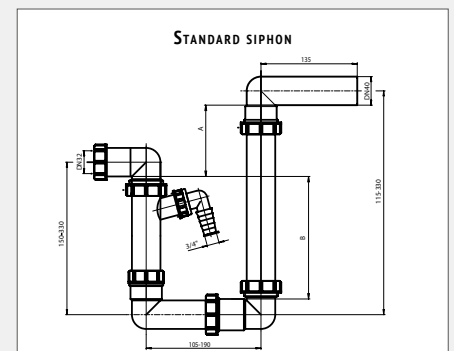
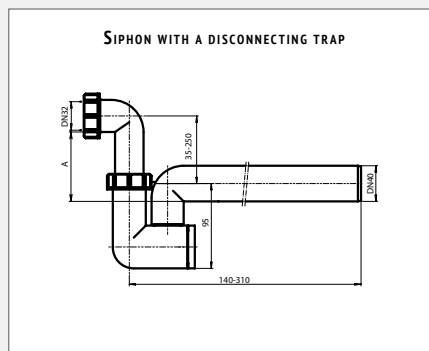

The standard siphon with the DN40 connection for the condensate is delivered for hygienic applications.

RECOMMENDATION

- If there is a risk of freezing, it is necessary to insulate the siphon and condensate draining piping, respectively keep the ambient temperature above freezing point (e.g. with an electric heating cable).
- The pipeline behind the siphon must be exhausted into free atmosphere.
- Negative pressure and overpressure siphons can be connected to the separate pipeline.
- An individual siphon can be used for each condensate drainage.

CONDENSATE DRAINAGE TRAY

The condensate drainage tray can be integrated into assemblies in which air humidity can condensate (e.g. coolers, plate exchangers, etc.) or assemblies which need to be equipped with the condensate drainage tray, and in some cases also with a drop eliminator, to separate air humidity from the transported air (e.g. outdoor inlet sections, some types of humidification assemblies, etc.) The tray is weathered and its declination and the condensate drainage neck diameter comply with sanitary requirements in accordance with EN 13053 and RLT_Richtlinie_1_2009, including VDI3803.

The condensate drainage is led through the side panel to the service side of the air-handling unit.

- Condensate drainage neck diameter D = 32 mm for standard applications
D = 40 mm hygienic applications

Depending on the application, the condensate drainage tray can be made of stainless steel AISI 304; X5CrNi18-10 ISO or AISI 316L; X2CrNiMo17-12-2 ISO

A suitable siphon can be ordered for condensate drainage.



DROP ELIMINATOR

The drop eliminator assemblies are used to trap water drops (from air humidity) that have condensed on the heat-exchange surfaces of heat exchangers.

The drop eliminator is made of stainless sheet steel fitted with vanes made of hardened polypropylene. The drop eliminator is equipped with a stainless condensate drainage tray and a drainage neck – tube of 32 mm diameter. Easy access to the drop eliminator assembly is ensured. The drop eliminator can easily be removed and cleaned. Two different drop eliminator types can be delivered. The type with T500 vanes can be used for lower air velocities while the type with T100 vanes can be used for higher air velocities. Recommended air velocities for T500 vanes are up to 3.2 m/s and for T100 vanes above 3.2 m/s. The T500 vanes can also be used for air velocities above 3.2 m/s; however, the efficiency will be reduced. The fins have a different shape.

MATERIALS AND DESIGN:

- As standard, stainless steel 304 AISI/X5CrNi18-10 ISO
- Special application (aggressive environments), stainless steel 316L AISI / X2CrNiMo17-12-2 ISO

DROP ELIMINATOR BUILDING LENGTH ACCORDING TO VANE TYPES

- | | |
|------------------------------|--------|
| ■ Eliminator with T500 vanes | 134 mm |
| ■ Eliminator with T100 vanes | 236 mm |

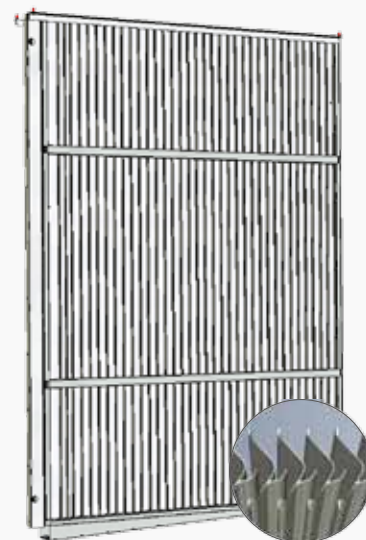
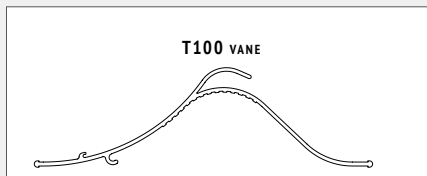
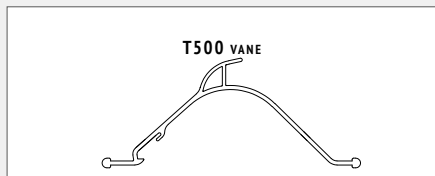

BLADE DAMPERS

The blade dampers are mostly used to regulate an air-handling system or close individual duct branches. The damper gears are enclosed in a damper frame. The dampers are accessible from the service side of the air-handling unit.

VARIANTS AND DESIGNS:

- Standard version (aluminium profiles) - air leakage class 2 (as per EN 1751)
- Standard version with increased corrosion protection (oxidized aluminium profiles, suitable for coastal areas) – air leakage class 2 (as per EN 1751)
- Class 4 version (aluminium profiles) for applications requiring higher air tightness and hygienic applications – air leakage class 4 (as per EN 1751).

DAMPER LOCATION:

- Internal (suitable for outdoor air-handling units)
- External (suitable for indoor air-handling units)

ACCESSORIES:

- Actuators
- Manual damper control
- Coupled dampers

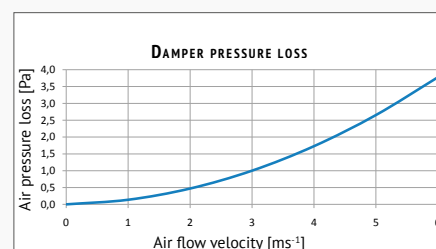
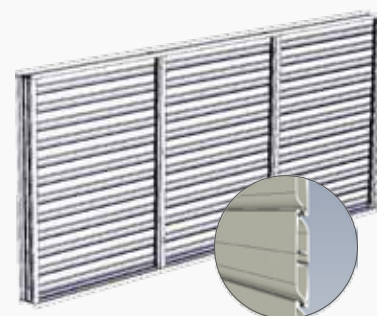

ACCESSORIES

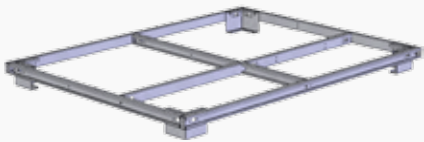
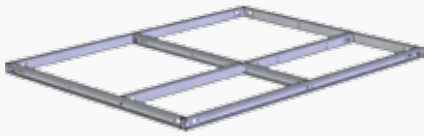

BASE FRAME

The base frame for AeroMaster Cirrus air-handling units is made of galvanized sheet steel, optionally hot-dip galvanized sheet steel. It is a part of each base assembly of the air-handling unit. It is created from unified C profiles.

For units 4 and 6 modules in height, a base frame 85 mm in height is manufactured, base frame with legs 180 mm in height and raised base frame 265 mm or 405 mm in height.

For units 8 modules in height, a base frame 150 mm in height is manufactured. Further, a base frame with legs 245 mm in height and a raised base frame 330 mm or 470 mm in height are available.

Maximum block/base frame ground-plan dimensions are 9 × 7 modules (respectively 7 × 9 modules). The blocks of dimensions 9 × 9, 9 × 8 and 8 × 9 modules cannot be transported by normal transport means so they must be transported disassembled.

END PANEL

The end panel is a part of the AeroMaster Cirrus air-handling unit. These panels are situated on the unit faces and serve for air outlet and inlet to the unit or to connect the unit accessories (expansion piece, blade damper, louvers or outlet adaptor).

ROOFS

Outdoor air-handling units are protected against weather effects, water accumulation and water penetration by pitched roofs.

The roofs consist of several components, including gutters. They are protected against wind by faces.

MATERIALS AND DESIGN

- Optionally, the roof can be made of aluminium or galvanized sheet steel.

VARIANTS AND DESIGNS:

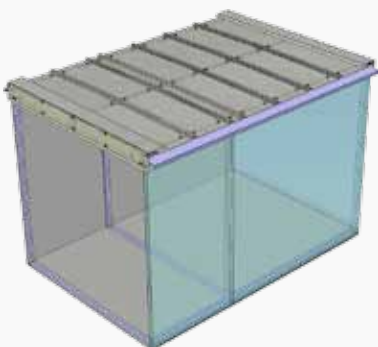

■ Roof for a standalone unit

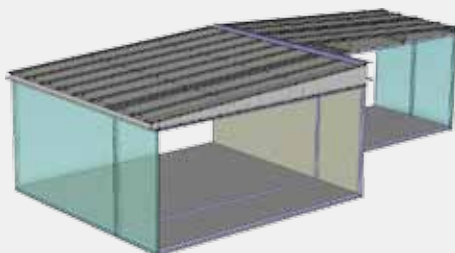

■ Roof for horizontally arranged units

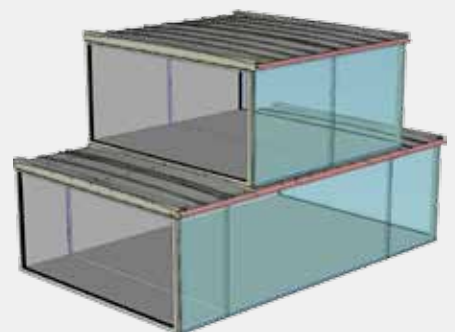

■ Roof for vertically arranged unit

LOUVERS

They protect the inlet or outlet of the air-handling unit AeroMaster Cirrus against rain and intrusion of small animals. The louver is created by the external casing and vanes. The louvers are fitted on the end panel of the first component in the inlet branch or the last component in the outlet branch. They are used as a functional element for outdoor applications.

Two narrower louvers side by side are used for the opening width of 5 to 9 modules. A one-piece louver is used for the opening width of 4 modules.



OUTLET ADAPTOR

This protects the inlet or outlet of the AeroMaster Cirrus air-handling unit against rain and intrusion of small animals. It is created by the external casing and protective grid. It can be fitted on the end panel of the last component in the outlet branch, respectively the first component in the inlet branch. It is used as a functional element for outdoor applications. Two narrower outlet adaptors side by side are used for the opening width of 5 to 9 modules. A one-piece outlet adaptor is used for the opening width of 4 modules.

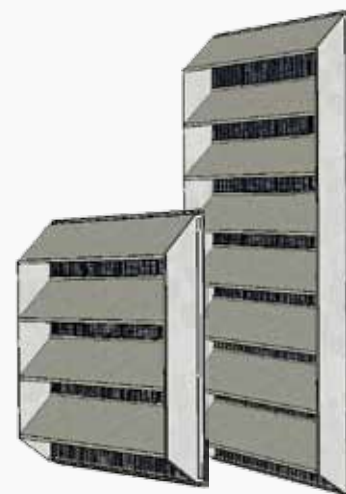

ELASTIC CONNECTION

The elastic connection eliminates the transfer of vibrations from the air-handling unit to the connected air duct.

MATERIALS AND DESIGN

The elastic connection is created by flanges (made of galvanized sheet steel) and a PVC sleeve which is reinforced with a polyamide textile. The flanges are interconnected with a conductive protective connection.

Heat resistance of the standard version is +80 °C.

The gas heater block must be connected to the air duct via an elastic connection featuring higher heat resistance.

For this purpose, we are able to deliver an elastic connection heat resistant up to +200 °C.

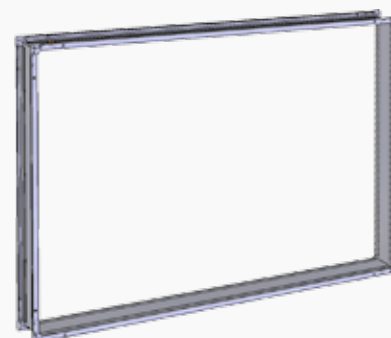

MIXING SETS

The mixing sets ensure continuous output control (proportional control using analogue voltage signal of 0-10 V) and protection of the water heater. Output control is ensured by a change in the water output temperature at constant water discharge. A mixing set connected to the control unit and antifreeze protection systems can effectively protect the heater against freezing followed by its destruction.

The mixing sets are delivered in accordance with the heat exchanger specifications. For detailed information on SUMX mixing sets, refer to the Vento Duct Units Catalogue and the AeroCAD design software. Remak only delivers mixing sets presented in the catalogue.

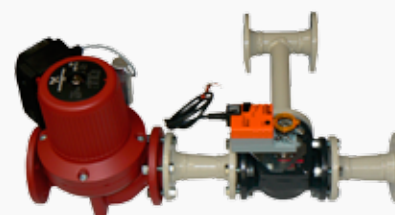



■ HMI-SG Controller



■ HMI-DM Controller



■ HMI-TM Controller



■ HMI@Web Control

COMPREHENSIVE SOLUTION

AeroMaster Cirrus air-handling units can be controlled by the VCS control systems. It can be delivered as part of the delivery and can be designed in the AeroCAD design software.

Major advantages of REMAK control systems:

- Reliability
- Simple to use
- Optimized for a specific air-handling assembly

VCS

VCS control units are compact control and power distributors used for the decentralized regulation and control of air-handling systems. They provide the equipment with high stability and safety while allowing easy control, including the viewing of operating states.

MAIN FEATURES

The VCS control unit is intended for the following:

- Complex autonomous control of air-handling systems
- Room air temperature control (cascade control)
- Supply and power actuation of air-handling systems
- Protection and safeguarding of connected components

Sophisticated control algorithms ensure system stability, user-friendly control and energy savings. Another advantage is that the control unit's features also contribute to energy savings in air-handling system operation:

- Option to set the unit to 2 temperature modes
 - Comfort
 - Economy
- Additional setting options:
 - Optimized start
 - Temperature start-up
 - Night chilling
- Time schedule setting options (daily or weekly time schedules)
- Precise drive control using data communications through the Modbus RTU bus
- Precise analogue control of controlled peripheral units (according to the controlled component)

The user can communicate with the VCS control unit via a local controller using the LonWorks, Modbus and BACnet communication standards, or can access the unit via internet and control it from an internet browser interface.

FREQUENCY INVERTERS

The frequency inverters are optimized to power the fan motors. They enable fan motor speed control and thus the air-handling unit's air flow rate control. The Vacon 10 standard degree of protection is IP21. The Vacon 100 frequency inverter is IP21 (IP54 on request).

ACTUATORS AND SENSORS

CAPILLARY THERMOSTAT

Auxiliary antifreeze protection sensor. The capillary tube of this thermostat is installed through the whole air-flow cross-section. If the temperature falls below the permissible level, this thermostat will activate antifreeze protection of the connected control system. A frame for the capillary thermostat is offered as an accessory.

TEMPERATURE SENSORS

The return water temperature is sensed by the high-speed response NS 130 / Ni1000 temperature sensor to enable the control system to react fast enough when the temperature falls below the permissible level. The sensor is situated directly in the water heat exchanger header on the return water side. Inlet air temperature sensing behind the heater is performed by the NS120/Ni1000 sensor. This sensor serves for both inlet air temperature control as well as antifreeze protection.

PRESSOSTAT

This is a pressure monitor. It signals exceeding of the preset pressure loss, e.g. filter fouling or fan malfunction.

PRESSURE GAUGES

Differential pressure gauges.

ROOM THERMOSTAT

This is used to set the required temperature.

ROOM TEMPERATURE SENSOR

This is used to compare the required temperature and current measured temperature.

CARBON MONOXIDE SENSORS

These sensors are intended to detect carbon monoxide in indoor areas, e.g. garages.

CARBON DIOXIDE IN AIR CONCENTRATION ROOM SENSORS

This sensor measures the concentration of CO₂ in the air.

PRESENCE AND MOTION DETECTION SENSORS

These are used to detect the movement of persons in exterior areas for heating, ventilation and air-conditioning purposes.

VOLATILE SUBSTANCE SENSORS (VOC)

Volatile Substance detection sensors (VOC) detect substances like kitchen vapours, vapours from rotting organic substances, etc.

CONSTANT PRESSURE/AIR-FLOW CONTROLLER

The control module has been combined with a pressure sensor. Changes in the 0–10 V output signal can be controlled depending on the pre-set differential pressure or required air volume air-flow.



UNITS FOR EXPLOSION AREAS

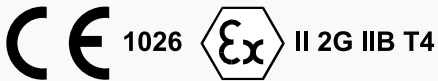

UNITS FOR EXPLOSION AREAS

AeroMaster Cirrus air-handling units meet the ATEX 100 Directive (European Parliament and Council Directive 94/9/ES) and can be delivered in both outdoor and indoor versions. Each unit in the ATEX version will be designed and calculated individually in accordance with the needs of the specific application.

A separate Conformity Certificate will be issued for each unit. The units in the ATEX version are checked and tested for safety by the independent Notified Body 1026/ AO 210 - FTZÚ Ostrava Radvanice. Each piece of equipment must be labelled in accordance with the specific explosive area of application.

Classification of AeroMaster Cirrus Air-Handling Units for Explosive Environments:

- The unit meets ATEX 100 (European Parliament and Council Directive 94/9/EC)
- FTZÚ Conformity Certificate
- Zone 1
- Equipment group (area of application)
- Category 2
- Gas explosive atmosphere G
- Explosive gas group IIB
- Heat class T4



Some differences between ATEX and standard versions:

- All the parts have a metal connection or contact to the central grounding point.
- The fan motors and impellers are type tested and certified in accordance with the ATEX Directive.
- Air filters are made of antistatic materials.
- Special bearings are used.
- Special grounding, conductive bridging and special grommets are used.
- The units are manufactured with higher casing air leakage L2 in accordance with ČSN EN 1886/2008.
- Special chemical composition of internal aluminium assemblies.
- All the internal assemblies are certified by the Notified Bodies for the whole EU area.

HYGIENE VERSION OF THE UNITS

HYGIENE VERSION OF THE UNITS

- These are manufactured based on the customer's specification in accordance with European standards.



The AeroMaster Cirrus units are designed for hygiene applications with an air-flow from 16,700 up to 49,600 m³/h. They have a specific finish of the internal connection of the sections, mounting and structure of the inbuilt assemblies, thus they comply with requirements for cleaning of the unit's internal areas. Thanks to the surface finish combinations (hot-dip galvanizing, powder coating, and stainless steel), which comply with the grade of atmosphere corrosiveness in accordance with EN 12500 and corrosion resistance in accordance with EN ISO 14713, the modular unit concept allows deliveries of air-handling units that fulfil the requirements of the highest applicable standards.

AIR-HANDLING UNIT PARAMETERS ACCORDING TO ČSN 1886:

- Heat transfer coefficient T3 class
- Thermal bridging: TB2/TB3 class
- Casing air leakage: L1, (M), L2 (R) class
- Filter wall air leakage: F9 class
- Casing deflection: D1/D2 class

SOME DIFFERENCES FROM STANDARD DESIGN:

- Section Connection
- Flat internal casing – top and side walls are powder coated, bottom wall is made of stainless material.
- Internal components (assemblies) are made of materials with enhanced resistance (painted, stainless materials, etc...)
- Inspection doors and internal components are situated so that they will enable inspections, cleaning and maintenance of the unit.
- The damper tightness class is 4 according to EN 1751



CONNECTION

DUCT CONNECTION DIMENSIONS											
Modules		Face outlet, full cross section (w × h)		Outlet upper/lower (w × h)		Side outlet (w × h)		Face mixing, upper/lower (w × h)		Side mixing (w × h)	
WIDTH	HEIGHT										
6	4	1840 mm	1230 mm	1840 mm	865 mm	1175 mm	1230 mm	1840 mm	560 mm	865 mm	1230 mm
7	4	2145 mm	1230 mm	2145 mm	865 mm	1480 mm	1230 mm	2145 mm	560 mm	1175 mm	1230 mm
8	4	2455 mm	1230 mm	2455 mm	865 mm	1480 mm	1230 mm	2455 mm	560 mm	1175 mm	1230 mm
9	4	2760 mm	1230 mm	2760 mm	865 mm	1785 mm	1230 mm	2760 mm	560 mm	1480 mm	1230 mm
4	6	1230 mm	1840 mm	1230 mm	1175 mm	865 mm	1840 mm	1230 mm	865 mm	560 mm	1840 mm
5	6	1535 mm	1840 mm	1535 mm	1175 mm	865 mm	1840 mm	1535 mm	865 mm	865 mm	1840 mm
6	6	1840 mm	1840 mm	1840 mm	1175 mm	1175 mm	1840 mm	1840 mm	865 mm	865 mm	1840 mm
7	6	2145 mm	1840 mm	2145 mm	1175 mm	1480 mm	1840 mm	2145 mm	865 mm	1175 mm	1840 mm
8	6	2455 mm	1840 mm	2455 mm	1175 mm	1480 mm	1840 mm	2455 mm	865 mm	1175 mm	1840 mm
9	6	2760 mm	1840 mm	2760 mm	1175 mm	1785 mm	1840 mm	2760 mm	865 mm	1480 mm	1840 mm
6	8	1840 mm	2455 mm	1840 mm	1480 mm	1175 mm	2455 mm	1840 mm	1175 mm	865 mm	2455 mm
7	8	2145 mm	2455 mm	2145 mm	1480 mm	1480 mm	2455 mm	2145 mm	1175 mm	1175 mm	2455 mm
8	8	2455 mm	2455 mm	2455 mm	1480 mm	1480 mm	2455 mm	2455 mm	1175 mm	1175 mm	2455 mm
9	8	2760 mm	2455 mm	2760 mm	1480 mm	1785 mm	2455 mm	2760 mm	1175 mm	1480 mm	2455 mm

MOLLIER H-X CHART

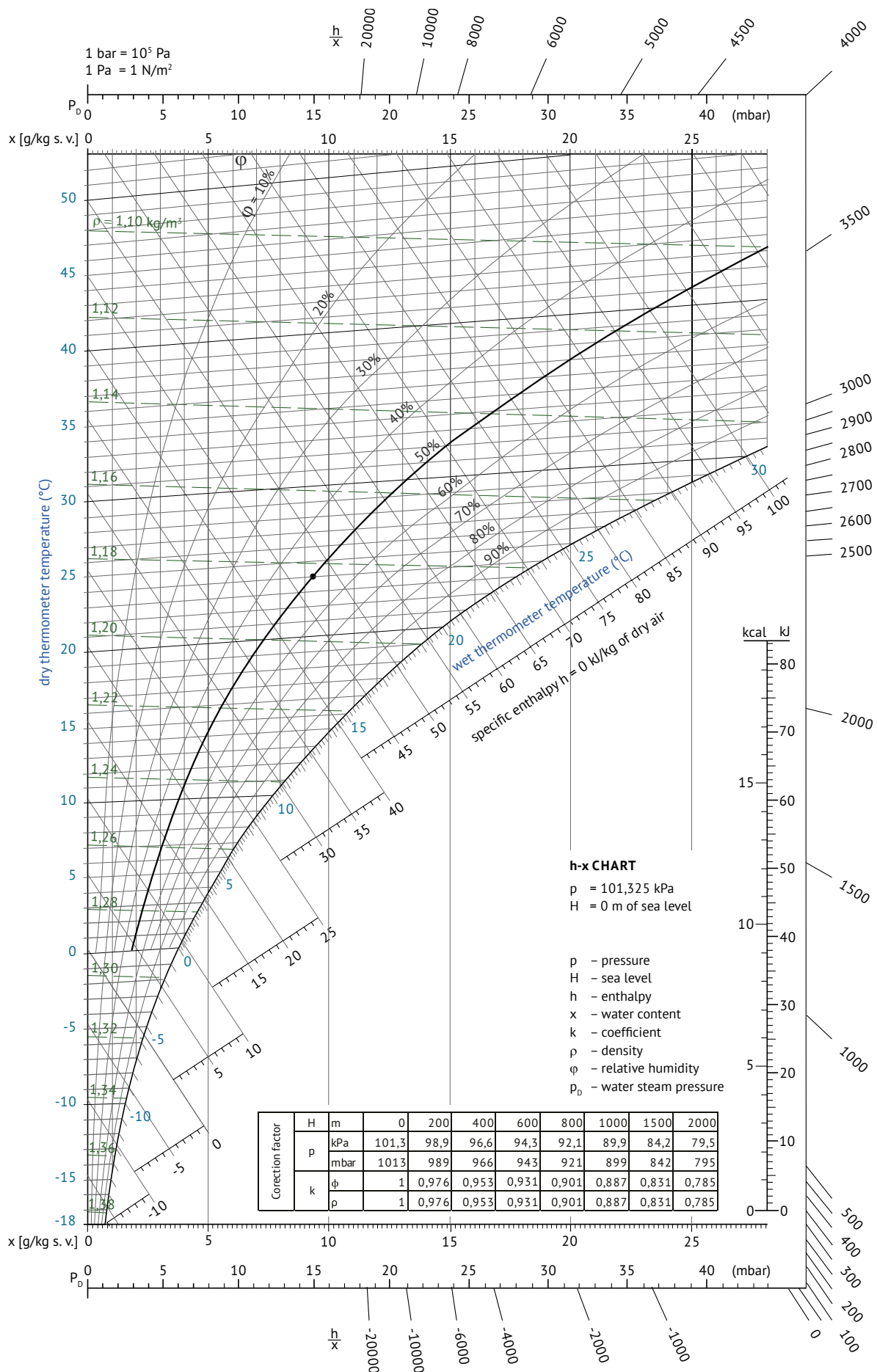

EASY-TO-GET OFFER

YOU HAVE A CLEAR REQUIREMENT...

Contact us:

- Tel: 00420 571 877 778
- Fax: 00420 571 877 777
- e-Mail: export@remak.cz



DO YOU WISH TO CONSULT YOUR DESIGN WITH US?

- Contact your personal consultant in REMAK – www.remak.cz
- We will design your unit together in your office.

... PROMPT DESIGN DURING PERSONAL MEETING



DO YOU WANT THE UNIT TO BE MADE-TO-MEASURE?

- Order your AeroCAD Professional design program.
- Register as an AeroCAD Professional program user.
- Create required unit, and send it to the following address: aerocad@remak.cz

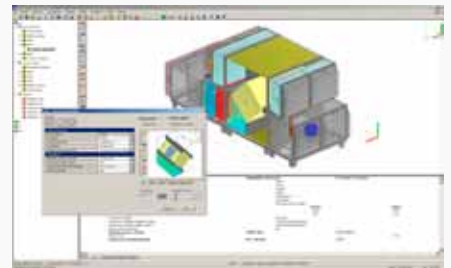

...IMMEDIATELY AVAILABLE TECHNICAL PARAMETERS AND THE PRICE

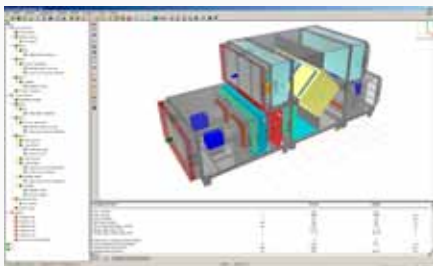
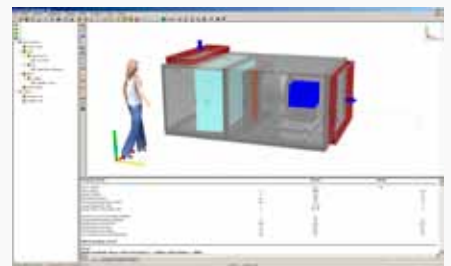

This Catalogue (as a whole or a part) must not be printed or copied without prior written permission from REMAK a. s., Zuberská 2601, Rožnov pod Radhoštěm, Czech Republic.

This „Catalogue“ are the sole property of REMAK a. s.

Changes reserved.

Issued: 26th March, 2013

Technical data updated on 26th March, 2013. Printing and language mistakes are reserved.



REMAK a. s.
Zuberská 2601
756 61 Rožnov pod Radhoštěm
Czech Republic
tel.: +420 571 877 778
fax: +420 571 877 777
www.remak.eu

